

HardieShingle®

HardieShingle® Siding Product Description

HardieShingle® siding is fiber-cement shingle siding for sidewall applications. HardieShingle siding is available as straight-edge panels or staggered-edge panels 48-in. long by 16-in. high. HardieShingle panels also come as decorative half-round shingles. For smaller coverage areas, individual shingles are also available in 4.2 in., 5.5 in., 6.75 in., 7.25 in. & 10 in. widths. Please see your James Hardie dealer for local availability of these products.

HardieShingle siding is available as a prefinished James Hardie product with ColorPlus® Technology. The ColorPlus coating is a factory applied, oven-baked finish available on a variety of James Hardie siding and trim products. See your local dealer for details and availability of products, colors and accessories.



Half-Round



New Staggered Edge Panel



New Straight Edge Panel



New Individual Shingles



Installation of HardieShingle® Siding

INDIVIDUAL SHINGLES

Like conventional wood-shingle siding, HardieShingle® siding requires the use of a starter strip and a starter course before installing the first full course of shingle panels or individual shingles. The starter strip sets the initial shingles at the proper angle and the starter course provides solid backing and keyway coverage for the first shingle course.

- 1) The starter strip should be installed over the water-resistive barrier. Starter strips can be made by ripping 1¼-in. lengths from full or partial planks of HardiePlank® siding.
- 2) Use HardiePlank 8¼-in. lap siding for the starter course.
- 3) Snap a level chalk line 8¼ in. up from the bottom edge of the starter strip.
- 4) Position the top of the starter course along the chalk line, use a straight edge on bottom of shingles if uniform straight edge is desired
- 5) The first course of shingle siding is then installed even with bottom edge of the starter course.

When installing individual HardieShingles, be sure to space shingles no more than ¼ in. apart. Spaces between shingles should not be within 1½ in. of the spaces in the courses above and below.

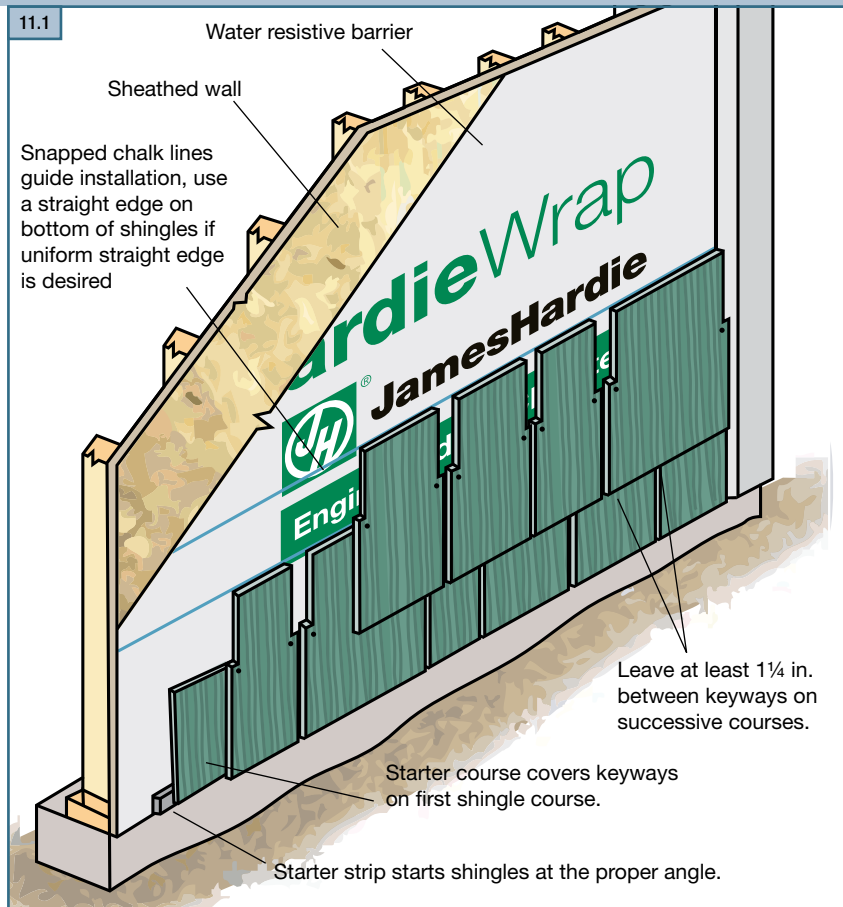

TIP: For the best appearance, apply shingle widths in a random manner to avoid creating a repeat pattern. Pre-planning of each course is recommended to aid appearance and to avoid stacked seams.

TIP: Stainless steel fasteners are recommended when installing James Hardie products.

HARDIESHINGLE SIDING FASTENER SPECIFICATIONS

The Fastener Specifications table shows fastener options for a variety of different nailing substrates. Please refer to the applicable ESR report online (see back page) to determine which fastener meets your wind load design criteria.

Fastening Substrate	Approved Fastener	Fastening Types	
		Fastener	Description
Individual Shingles	9	Roofing nail	Minimum 15/32 in. thick plywood
	4	Siding nail	Minimum 7/16 in. thick OSB sheathing
HardieShingle Panels	6	Ring Shank Siding Nail	16 in. or 24 in. O.C. wood studs
	13	ET&F Panelfast	Directly to minimum 7/16 in. thick OSB
Individual and Shingle Panels	13	Masonry nail	16 in. or 24 in. O.C. steel studs
	14	Masonry nail	

Corrosion-resistant siding nails 1¼-in. long should be used to apply individual HardieShingles® to minimum 7/16-in. OSB rated sheathing. Position nails ½ in. to 1 in. from the side edges of the shingles and 8½ in. to 9 in. up from the bottom edge of the shingle.

2 nails per shingle on 4.2-in., 5.5-in., 6.75-in., 7.25-in., and 10-in. shingles

9.2

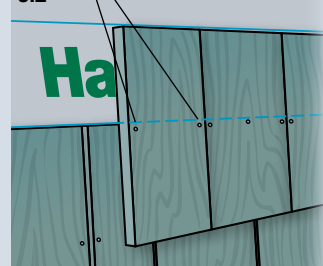

Installation of HardieShingle® Siding (continued)

General Product Information

Working Safely

Tools for Cutting and Fastening

General Installation Requirements

General Fastener Requirements

Finishing and Maintenance

HardieWrap® Weather Barrier

HardieTrim® Boards/Battens

HardieSoffit® Panels

HardiePlank® Lap Siding

HardieShingle® Siding

HardiePanel® Vertical Siding

Appendix/Glossary

ESR-1844 & 2290 Report

HARDIESHINGLE® PANELS

For HardieShingle® panels start at one end and work across the wall.

- 1) Measure and trim the first panel to make sure the end of the panel falls over framing.
- 2) Using the chalk line as a guide along the panel top edge. For straight edge panels align bottom panel edges to maintain a uniform straight line carefully position the panels and secure with suitable fasteners and spacing for your particular application as noted in the ESR 1844 & 2290 Report.
- 3) Align the bottom edges of the trim and the siding for the best appearance. Where the panel begins at a corner board or at door or window casings, cut the upper portion of the panel back even with the edge of the keyway.
- 4) Where the siding meets the HardieTrim® board, leave a 1/8-in. gap between the siding and trim. Install HardieShingle panels with joints in moderate contact.

11.2

When installing panels over minimum 7/16-in. OSB rated sheathing, drive nails no more than 13 3/4 in. apart.

Snapped chalk lines help guide installation, use a straight edge on bottom of Straight Edge panels if uniform straight edge is desired

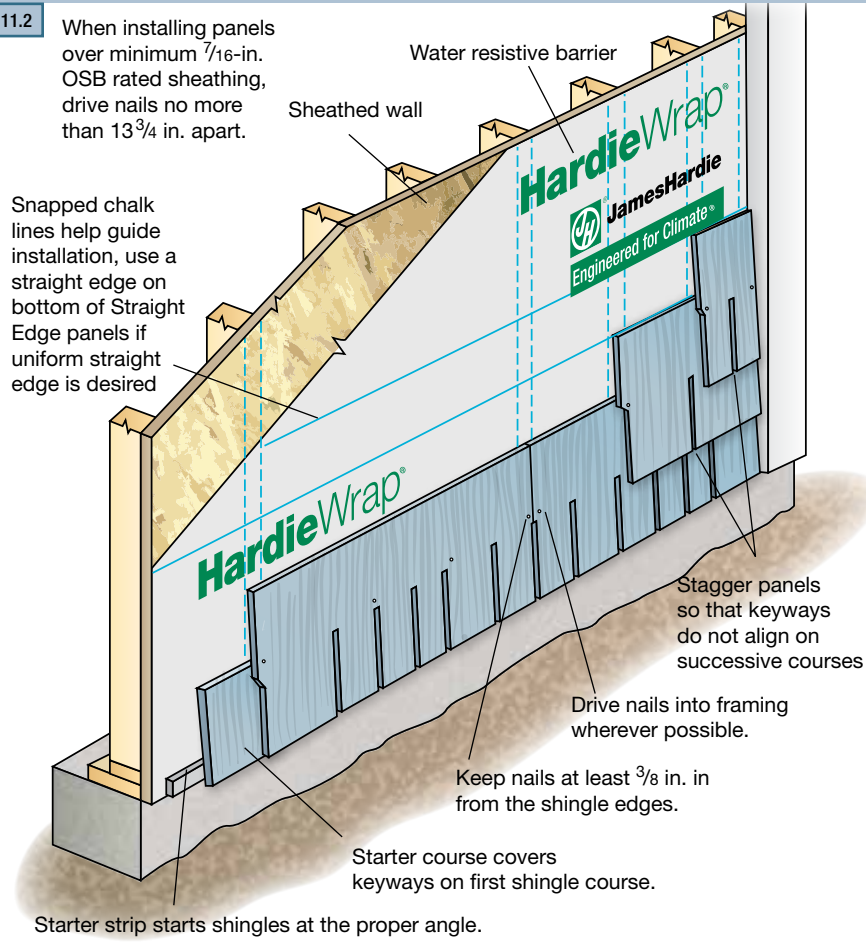

- 5) Measure and cut the first panel for the second course of HardieShingle panel so that it lands on the stud before the panel on the first course. Use the cut end to abut the trim.
- 6) Start the third course with the end of the panel landing on the stud before the second course. Save the cut pieces to use on the other end of the wall.
- 7) Continue alternating these three lengths up the wall to establish proper positioning of the shingle keyways.

When installing HardieShingle Staggered Edge panel, measure up 6 in. from the top of the installed panel and make a mark. Make another mark at an equal height on the opposite end of the wall and snap a chalk line between the marks. Align the top of the next course of panel with the chalk line to maintain proper exposures.

Keep the bottom of the siding even with the bottom of the trim. If desired, the trim may extend below the bottom of the siding, but the siding should not hang below the trim. Make sure that clearances above the ground, roof lines and hard surfaces are in accordance with the General Requirements on pages 13-26.

11.3

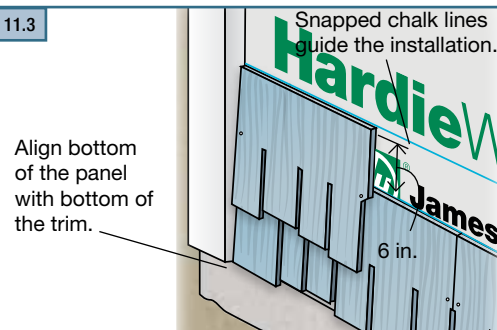

TIP: A straight edge panel can be used on the bottom course if desired



WARNING

James Hardie recommends installing HardieShingle panel over rated wood sheathing.

INSTALLING HARDIESHINGLE® PANEL DIRECT TO 7/16 IN. SHEATHING

Refer to ESR-2290 for allowable wind loads.

Panel and Individuals may be mixed together to reduce waste and save time.

Straight Wall

- 1) Always work from center of wall to outside corner trim
- 2) Make all shingle length cuts at trim, not mid wall
- 3) Start first panel to left of center
- 4) If openings exist on wall, locate offset layout on each side of opening
- 5) Start second row of shingle on centerline of offset layout
- 6) Start third row of shingle on right line of offset layout
- 7) Repeat starting panel on remaining rows using Left, Middle, Right layout lines

Gable

- 1) Layout offset on gable similar to straight wall, except vertical layout lines should be made across the gable face at the offset dimension
- 2) Utilize three center lines for starting row
- 3) Start first piece on the left vertical line, left of center
- 4) Use the additional vertical lines to pre measure finishing pieces
- 5) Start Second row on the vertical centerline of the gable face
- 6) Start third row on vertical line to the right of center
- 7) Repeat starters Left, Middle, Right for remaining courses

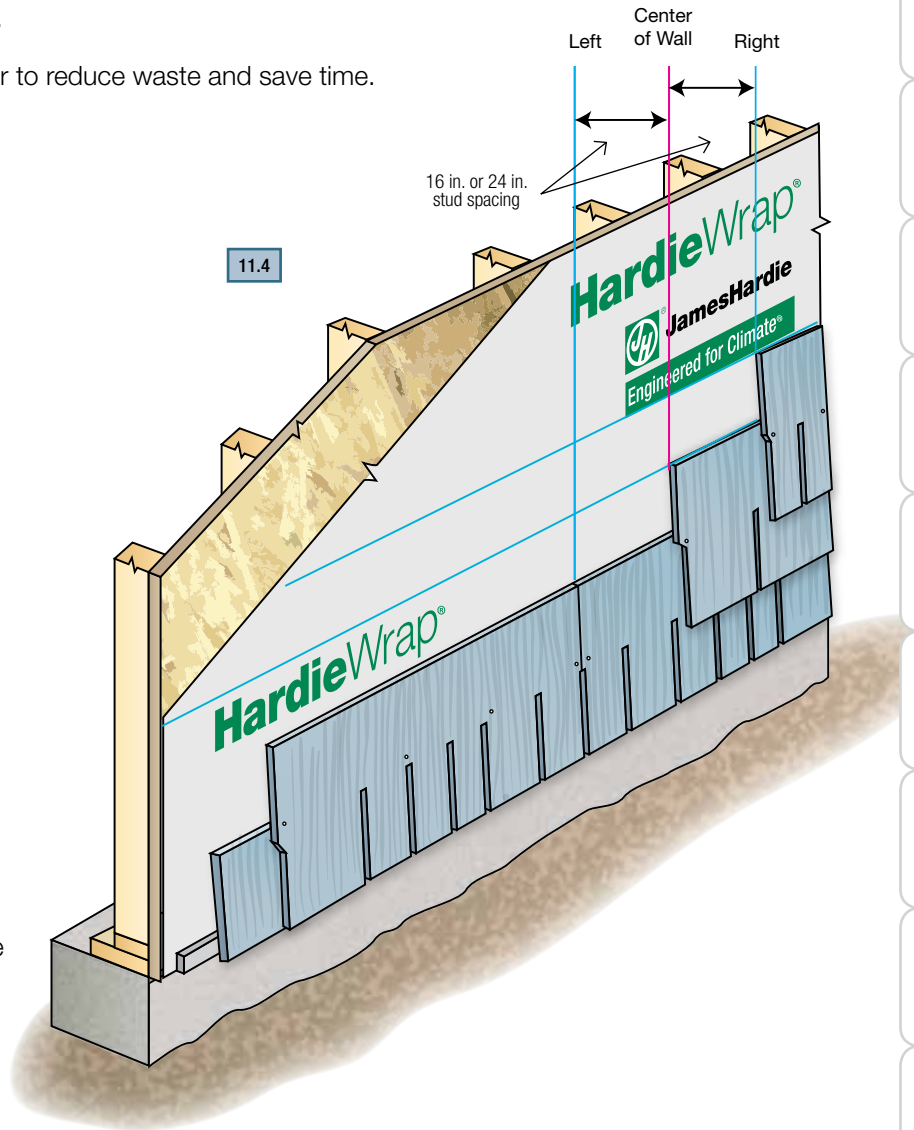

Installation of HardieShingle® Siding (continued)

HALF-ROUND DECORATIVE SHINGLE PANELS

Half-round shingles are often used for a decorative note above regular shingles, especially in gables.

- 1) Start the first course from the middle of the run so that half round sections at either end are cut equally.
- 2) Then start the second course from the trim at one end and cut it so that it lands on the framing one stud away from the course below.
- 3) Cut the panel to abut the trim at the other end of the course. Make sure keyways are located over the midpoints of the half rounds in the lower course for correct alignment.
- 4) At the top of the wall, install a frieze board and install shingles up to the bottom edge of the frieze.
- 5) Top rows of shingles may have to be cut to an appropriate height to maintain consistent exposure top to bottom.

All HardieShingle® siding products can be applied to the gable end of a building following their specific installation instructions. But special care should be taken when installing half-round panels due to their symmetrical nature.

For best appearance, half-round shingle panel installations on gable ends should end with a single round shingle at the gable peak. To make this happen, calculation of the actual number of courses is necessary. Follow the simple steps below to achieve this effect.

- 1) Measure the horizontal width of the gable being sided and locate the center of the gable. Using a level or chalk line, draw a line from the gable peak to the center mark.
- 2) Measure the entire height of the gable area to be sided above the band board.
- 3) Divide the total height of the gable by 7. (Half round shingles have an exposure of 7 in. and this figure is the number of courses to be installed.
- 4) If the answer is an even number (example: 70 in. divided by 7 = 10 courses), center the first panel course on a keyway on the vertical center line (*fig. 9.7*). If the answer is an odd number, (example: 77 in. divided by 7 = 11 courses) center the first course on the center of a half-round shingle (*fig. 9.8*).

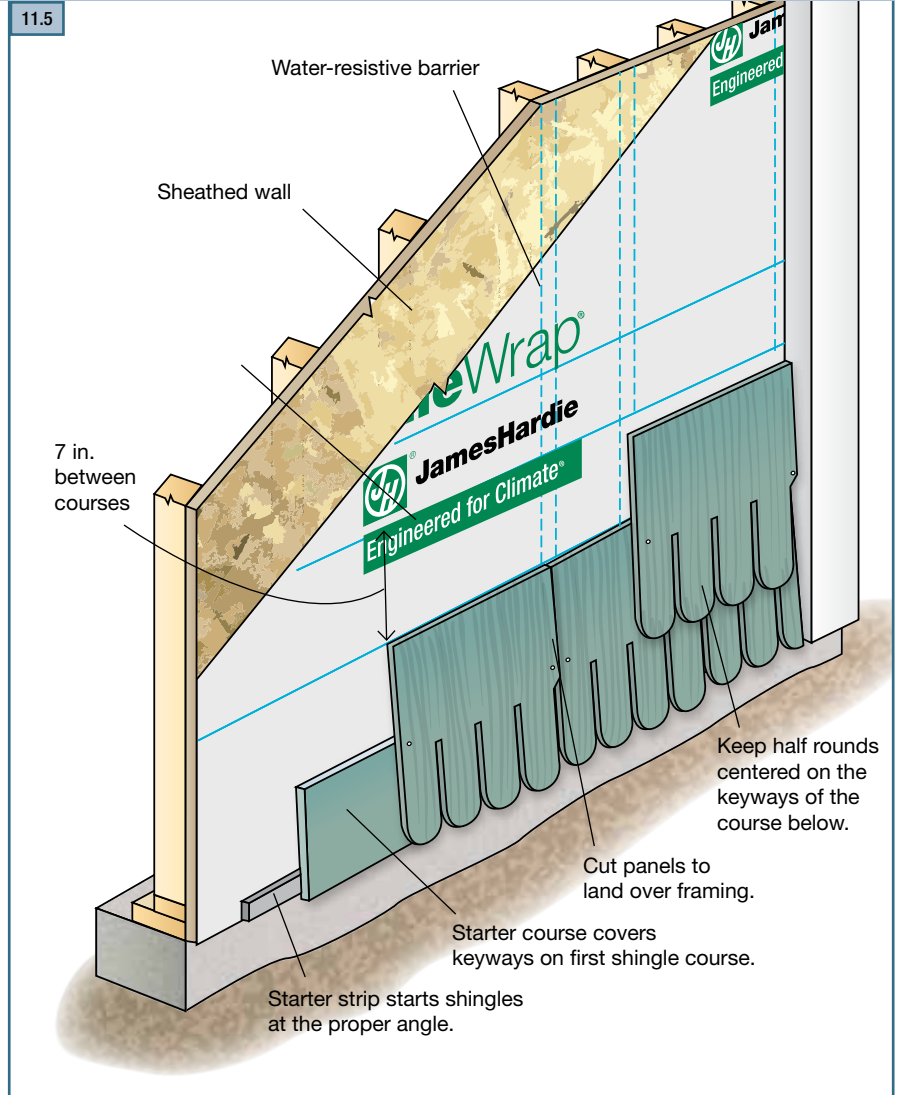

Installation of HardieShingle® Siding (continued)

- 5) Using this planning method, the final piece at the peak should be a centered shingle.

To install the first course of half-round panel in a gable:

- 1) position the first piece of panel on the gable centerline marked earlier. The panel may be moved left or right to make the edge lands on a stud as long as the shingle face or keyway is centered (depending on the number of courses needed as discussed above).
- 2) Drive nails approximately $\frac{1}{4}$ in. above the top of every other keyway. Avoid driving nails between the keyways because the heads may be visible through the keyways of subsequent courses.
- 3) Complete the installation on the left and right sides using the rake-angle template to cut the proper rake angle. Leave a $\frac{1}{8}$ -in. gap between the siding and trim boards.
- 4) Use the rake angle template to trim back the start panel for the 2nd course. Install the 2nd and following courses the same way. At the peak of the gable, face nail the final piece with a finish nailer.

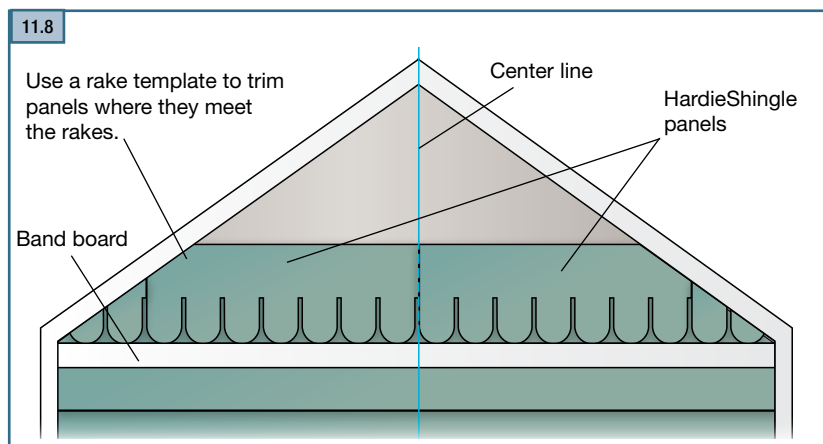
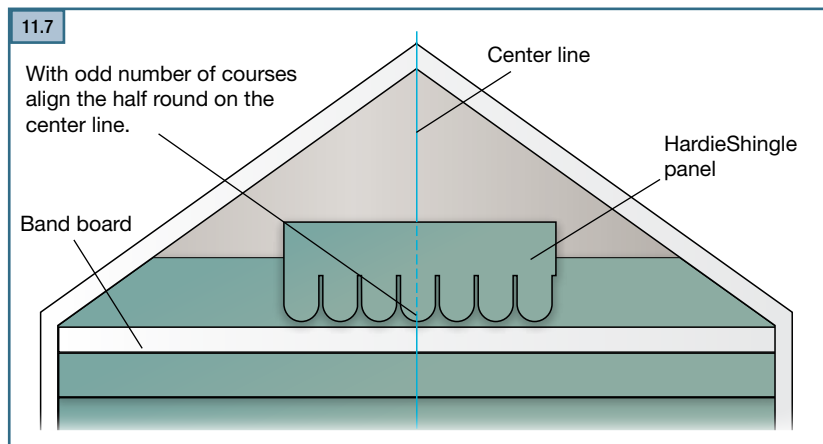
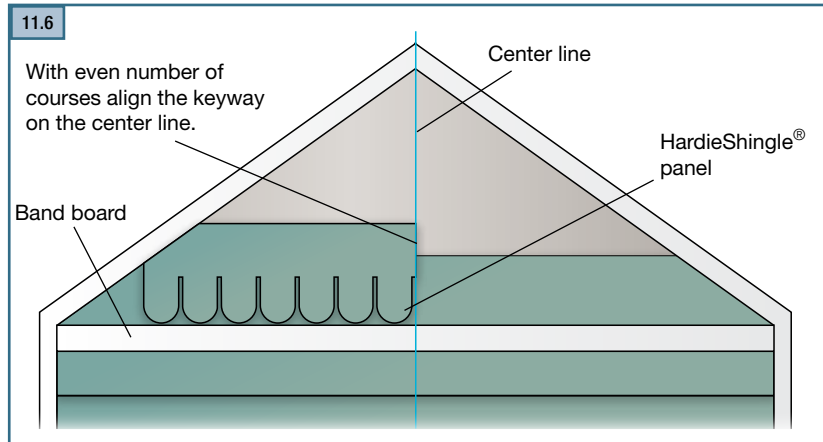

IMPORTANT: FAILURE TO INSTALL AND FINISH THIS PRODUCT IN ACCORDANCE WITH APPLICABLE BUILDING CODES AND JAMES HARDIE WRITTEN APPLICATION INSTRUCTIONS MAY LEAD TO PERSONAL INJURY, AFFECT SYSTEM PERFORMANCE, VIOLATE LOCAL BUILDING CODES, AND VOID THE PRODUCT ONLY WARRANTY. BEFORE INSTALLATION, CONFIRM THAT YOU ARE USING THE CORRECT HARDIEZONE™ INSTRUCTIONS. TO DETERMINE WHICH HARDIEZONE™ APPLIES TO YOUR LOCATION, VISIT WWW.HARDIEZONE.COM OR CALL 1-866-942-7343 (866 9HARDIE)

STORAGE & HANDLING:

Store flat and keep dry and covered prior to installation. Installing siding wet or saturated may result in shrinkage at butt joints. Carry planks on edge. Protect edges and corners from breakage. James Hardie is not responsible for damage caused by improper storage and handling of the product.

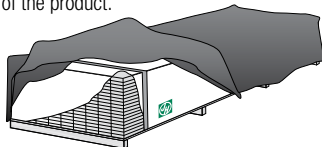

CUTTING INSTRUCTIONS

OUTDOORS

1. Position cutting station so that wind will blow dust away from user and others in working area.
2. Use one of the following methods:
 - a. Best:
 - i. Shears (manual, electric or pneumatic)
 - b. Better:
 - i. Dust reducing circular saw equipped with a HardieBlade® saw blade and HEPA vacuum extraction
 - c. Good:
 - i. Dust reducing circular saw with a HardieBlade saw blade (only use for low to moderate cutting)

INDOORS

1. Cut only using shears (manual, electric or pneumatic).
 2. Position cutting station in well-ventilated area
- NEVER use a power saw indoors
- NEVER use a circular saw blade that does not carry the HardieBlade saw blade trademark
- NEVER dry sweep – Use wet suppression or HEPA Vacuum

Important Note: For maximum protection (lowest respirable dust production), James Hardie recommends always using "Best" -level cutting methods where feasible.

NIOSH-approved respirators can be used in conjunction with above cutting practices to further reduce dust exposures. Additional exposure information is available at www.jameshardie.com to help you determine the most appropriate cutting method for your job requirements. If concern still exists about exposure levels or you do not comply with the above practices, you should always consult a qualified industrial hygienist or contact James Hardie for further information.

SD083105

GENERAL REQUIREMENTS:

- HardieShingle® panels can be installed over braced wood or steel studs spaced a maximum of 24" o.c. or directly to minimum 7/16" thick sheathing. See general fastening requirements.
- Information on installing James Hardie products over foam can be located in **JH Tech Bulletin 19** at www.jameshardie.com
- A water-resistive barrier is required in accordance with local building code requirements. The water-resistive barrier must be appropriately installed with penetration and junction flashing in accordance with local building code requirements. James Hardie will assume no responsibility for water infiltration. James Hardie does manufacture HardieWrap® Weather Barrier, a non-woven non-perforated housewrap¹, which complies with building code requirements.
- When installing James Hardie® products all clearance details in figs. 1,2,3,4,5,6 & 7 must be followed.
- Adjacent finished grade must slope away from the building in accordance with local building codes - typically a minimum of 6" in the first 10'.
- Do not install James Hardie products, such that they may remain in contact with standing water.
- HardieShingle panels may be installed on vertical wall applications only.
- DO NOT use stain, oil/alkyd base paint, or powder coating on James Hardie® Products.

CLEARANCES

Install siding and trim products in compliance with local building code requirements for clearance between the bottom edge of the siding and the adjacent finished grade.

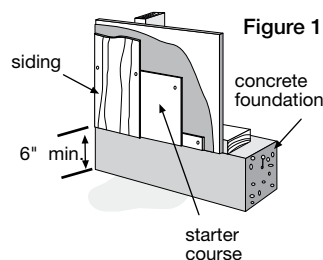

Figure 1

Maintain a minimum 2" clearance between James Hardie® products and paths, steps and driveways.

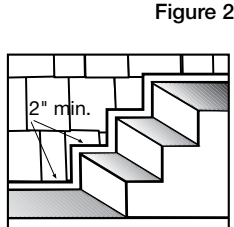

Figure 2

Maintain a minimum 2" clearance between James Hardie products and decking material.

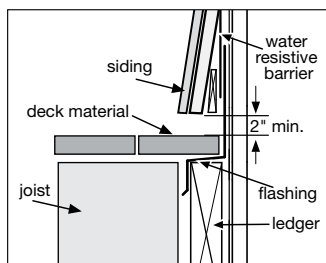

Figure 3

At the juncture of the roof and vertical surfaces, flashing and counterflashing shall be installed per the roofing manufacturer's instructions. Provide a minimum 2" clearance between the roofing and the bottom edge of the siding and trim.

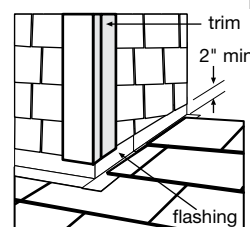

Figure 4

¹For additional information on HardieWrap® Weather Barrier, consult James Hardie at 1-866-4Hardie or www.hardiewrap.com

† The illustration (figure 7) and associated text was reprinted with permission of THE JOURNAL OF LIGHT CONSTRUCTION. For subscription information, visit www.jlconline.com.

WARNING: AVOID BREATHING SILICA DUST

James Hardie® products contain respirable crystalline silica, which is known to the State of California to cause cancer and is considered by IARC and NIOSH to be a cause of cancer from some occupational sources. Breathing excessive amounts of respirable silica dust can also cause a disabling and potentially fatal lung disease called silicosis, and has been linked with other diseases. Some studies suggest smoking may increase these risks. During installation or handling: (1) work in outdoor areas with ample ventilation; (2) use fiber cement shears for cutting or, where not feasible, use a HardieBlade® saw blade and dust-reducing circular saw attached to a HEPA vacuum; (3) warn others in the immediate area; (4) wear a properly-fitted, NIOSH-approved dust mask or respirator (e.g. N-95) in accordance with applicable government regulations and manufacturer instructions to further limit respirable silica exposures. During clean-up, use HEPA vacuums or wet cleanup methods - never dry sweep. For further information, refer to our installation instructions and Material Safety Data Sheet available at www.jameshardie.com or by calling 1-800-9HARDIE (1-800-942-7343). FAILURE TO ADHERE TO OUR WARNINGS, MSDS, AND INSTALLATION INSTRUCTIONS MAY LEAD TO SERIOUS PERSONAL INJURY OR DEATH.

SD060905

Maintain a 1/4" clearance between the bottom of James Hardie® products and horizontal flashing. Do not caulk gap.

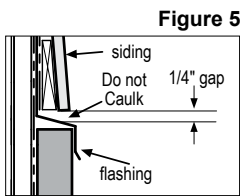

Figure 5

Maintain a minimum 1" gap between gutter end caps and siding & trim.

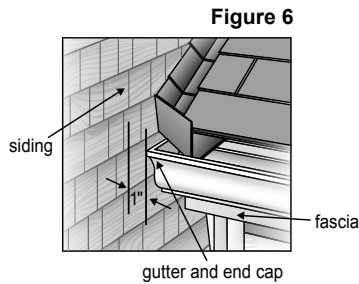
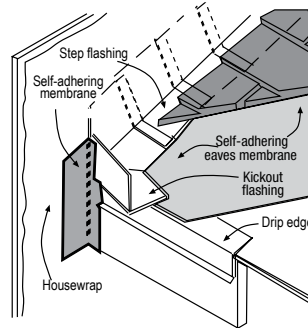

Figure 6

Figure 7



KICKOUT FLASHING

Because of the volume of water that can pour down a sloped roof, one of the most critical flashing details occurs where a roof intersects a sidewall. The roof must be flashed with step flashing. Where the roof terminates, install a kickout to deflect water away from the siding.

It is best to install a self-adhering membrane on the wall before the subfascia and trim boards are nailed in place, and then come back to install the kickout.

Figure 7, Kickout Flashing To prevent water from dumping behind the siding and the end of the roof intersection, install a "kickout" as required by IRC code R905.2.8.3 : "...flashing shall be a min. of 4" high and 4" wide." James Hardie recommends the kickout be angled between 100° - 110° to maximize water deflection

TRIM CONSIDERATION:

Minimum 1" trim thickness is needed as Panels stack at a depth of roughly 15/16" for the 7" reveal. If additional trim depth is desired, you can place a spacer under the trim (Fig. 8C & 8D) DO NOT install trim over HardieShingle.

BLOCKED PENETRATIONS

Penetrations such as hose bibs and holes 1 1/2" or larger such as dryer vents shall have a block of trim around point of penetration.

Figure 8A

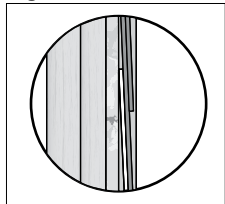

Figure 8B

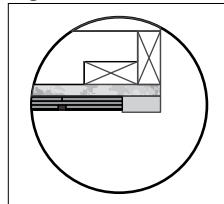

Figure 8C

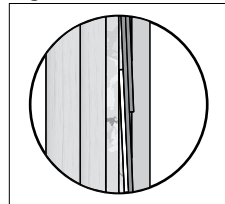
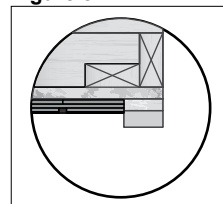

Figure 8D



GABLE INSTALLATION:

Installation over sheathing is recommended (Required for Individuals) for gables.*

- 1) Find the center stud of your of your Gable and snap a caulk line down
- 2) Measure out 16"* to both the left and the right of the center line and snap a caulk line
- 3) Measure up 2" if you are off a roof line or 1/4" if you are starting above a band board
- 4) Set the bottom of your 1 1/4" starter strip at that line
- 5) Place your 8 1/4" Starter Course -bottom level with the bottom of the starter strip
- 6) Set your first row of Shingle - starting the first piece at the vertical line left of center
(If you are using staggered edged shingles Trim down the first row to the shortest shingle length)
- 7) Drive nails approximately 1/4" above Key ways 5 per full panel Center Nail can be either one of the keyways.
(Stay by keyway to avoid shiners) (EX1) Blue Dots show nail placement
- 8) Measure up 7" with straight and 6" with Staggered edge and snap a caulk line to get your proper exposure
- 9) The second row will start at the center line
- 10) The Third row will start at the line right of center
- 11) As you work your way up the gable make sure you Keep your Cut Pieces you will use the pieces on the edges of the gable (EX2)
- 12) Edges Gable butting into trim leave a 1/8" Gap (for house movement and Caulking)
- 13) Make sure to sure siding nails on the small pieces on the edges (Do not use a trim nail to install!)

Figure 9

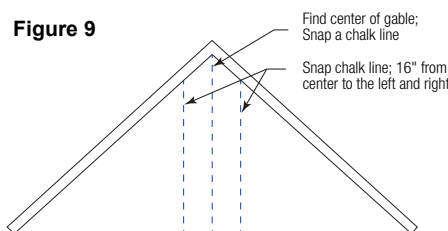

Figure 10

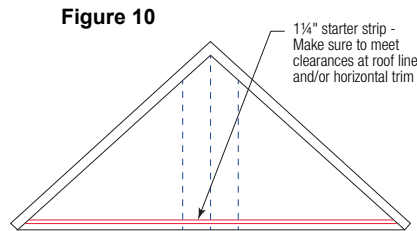

Figure 11

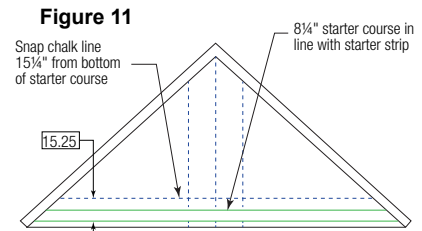

Figure 12

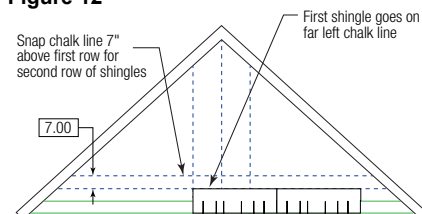

Figure 13

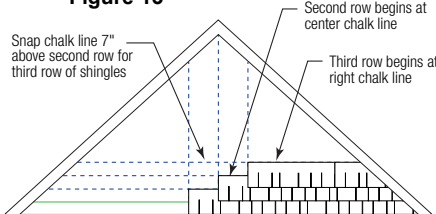
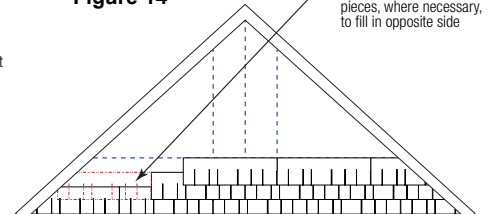

Figure 14



*Panels can also be installed direct to stud up to 24"OC.

Note: Snapped chalk lines help guide installation, when installing straight edge panels or Individual shingles use a straight edge on bottom edges if uniform straight edge is desired.

HARDIESHINGLE® STAGGERED EDGE PANELS INSTALLATION

Fastener Requirements

0.083" x 0.187" HD x 1 1/2" long ringshank nails are used for fastening HardieShingle® Staggered Edge Panels to both framing and to 7/16" thick APA rated sheathing.

HardieShingle® Staggered Edge Panel Installation

Install HardieShingle® panels with joints butted in moderate contact. Due to overlapping of the joints, caulk is not required except where panels abut trim boards. (fig. 13 & 15). Ensure keyways do not line up on subsequent courses.

- 1) Install a 1-1/4" starter strip, then install a 8-1/4" wide HardiePlank® lap siding starter course.
- 2) Place first panel so that panel end centers over stud. Trim panel as needed. Butt the cut end into trim as shown (figs 13 & 15). When installing over a band board or any horizontal surface, leave 1/4" gap between bottom of siding and flashing.
- 3) Secure panel, leaving 1/8" gap for caulk at trim and continue the course along the wall.
- 4) Start the second course, by removing the equivalent of one full stud cavity (16" or 24" OC), again abutting the cut end into the trim (figs 13 & 15). This is to prevent pattern repetition. Repeat step 3.
- 5) Start the third course, by removing the equivalent of two full stud cavities (figs 13 & 15) and repeat step 3.
- 6) Continue up the wall repeating steps 2 through 6 until desired height is reached.

Note: For aesthetic purposes you may trim the bottom of the panel to create a straight edge. If doing so, ensure all cuts ends are properly sealed and painted (fig 14)

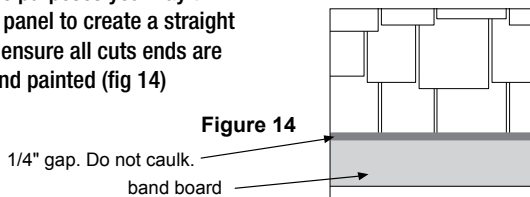
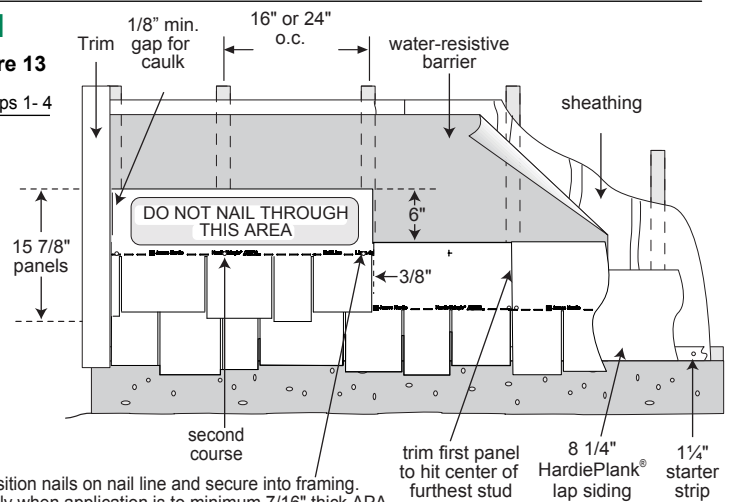

Figure 13

Steps 1 - 4



position nails on nail line and secure into framing. Only when application is to minimum 7/16" thick APA rated sheathing, position nails on nail line spaced a maximum of 13 3/4" o.c. Allow 3/8" from panel edges.

Steps 5 & 6

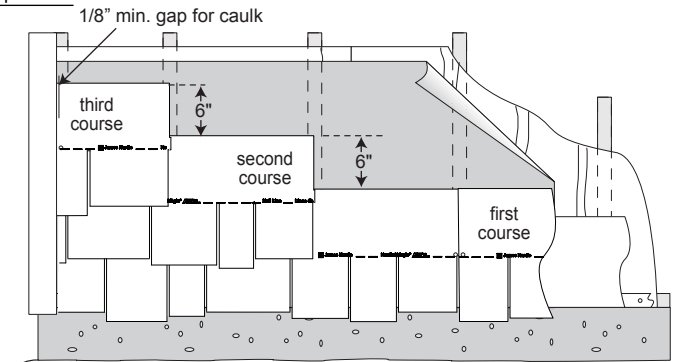

HARDIESHINGLE® STAGGERED EDGE PANEL COVERAGE

Panels for sidewall applications are available in 48" lengths. Pieces needed for one square (100sq.ft.) of product coverage = approximately 50, based on a maximum 6" exposure from the top edge of HardieShingle panels in subsequent courses (refer to Figure 13).

7" EXPOSURE HARDIESHINGLE® STRAIGHT EDGE PANELS INSTALLATION (For 5" exposure product please go to page 6)

Maximum Exposure of 7"

REFER TO STAGGERED EDGE INSTRUCTIONS ABOVE

Steps 1 - 4

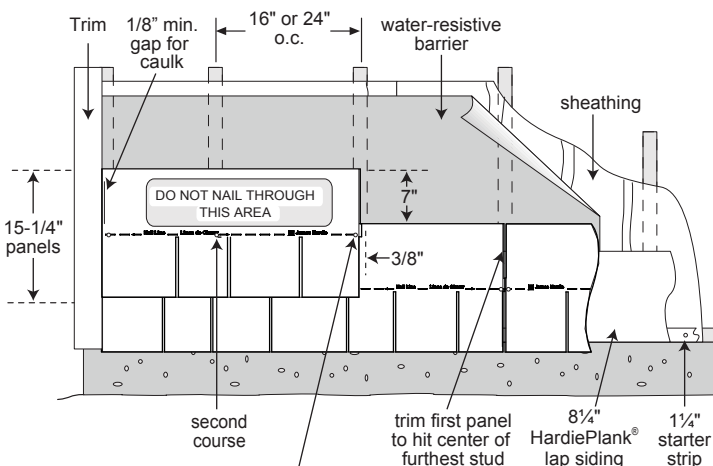

position nails on nail line and secure into framing. Only when application is to minimum 7/16" thick APA rated sheathing, position nails on nail line spaced a maximum of 13 3/4" o.c. Allow 3/8" from panel edges.

Figure 15

Steps 5 & 6

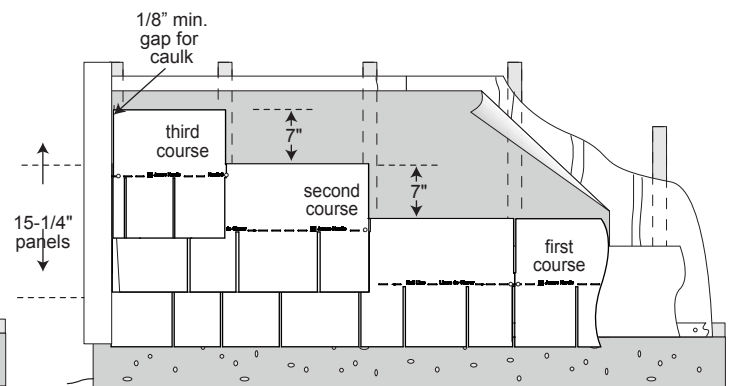

HARDIESHINGLE® STRAIGHT EDGE PANEL COVERAGE

Panels for sidewall applications are available in 48" lengths. Pieces needed for one square (100sq.ft.) of product coverage = approximately 43, based on maximum 7" exposure.

HARDIESHINGLE® INDIVIDUAL SHINGLE INSTALLATION

HardieShingle® Individual Shingles must be installed with the widest part of the shingle placed downwards and directly to minimum 7/16" thick sheathing.

Fastener Requirements

0.091" x 0.221" HD x 1 1/2" or 0.121" x 0.371" HD x 1 1/4" long corrosion resistant siding nails are used for fixing HardieShingle siding to 7/16" thick APA rated sheathing.

HardieShingle® Individual Shingle Installation

Due to overlapping of the joints, caulk is not required except where panels butt trim boards. Space shingles a maximum 1/4" apart and leave a minimum lap of 1 1/2" between successive courses (fig. 17).

- 1) Install 1 1/4" starter strip and a 8 1/4" wide HardiePlank® siding starter course.
- 2) Install first shingle from the end abutting trim. Install widest part of shingle placed downwards. (fig. 16).
- 3) Secure shingle, leaving a 1/8" gap for caulk at trim and continue the course along the wall.
- 4) Start the second course, leaving a minimum lap of 1 1/2" between successive courses, again from the end abutting the trim. Repeat step 3.
- 5) Continue up the wall repeating steps 2 through 5 until desired height is reached.

Figure 16

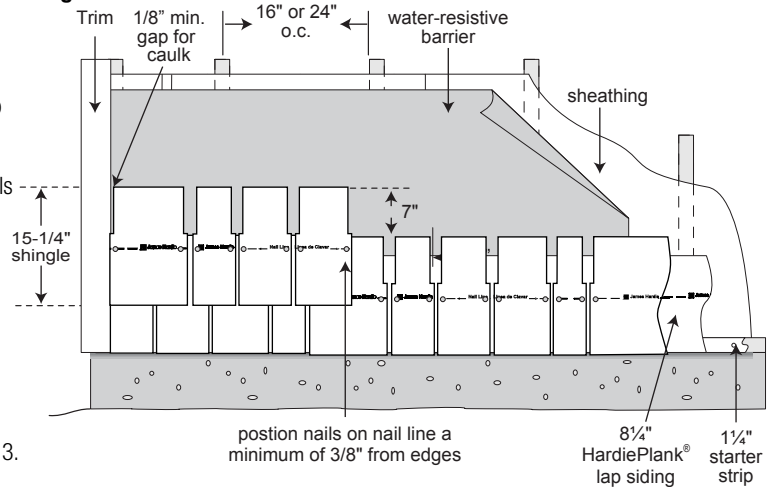

HARDIESHINGLE® INDIVIDUAL SHINGLE COVERAGE

Individual Shingles for sidewall applications are available in assorted widths as listed below. Bundles needed for one square (100 sq. ft.) of product coverage:

Shingle Width	Number of Bundles	Pieces per Bundle
4-3/16"	3	15
5-1/2"	6	15
6-3/4"	3	15
7-1/4"	6	15
10"	3	15

Figure 17

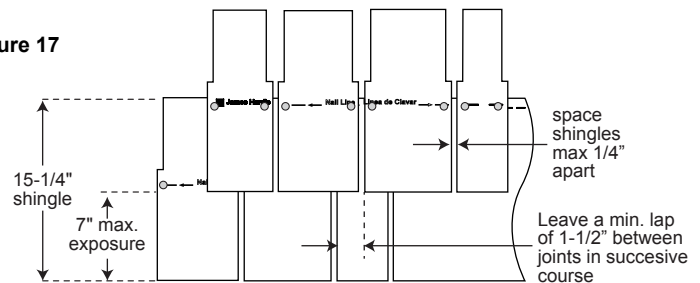

! Install with the widest part of the shingle placed downwards

HARDIESHINGLE® HALF-ROUND PANELS INSTALLATION

Fastener Requirements

0.083" x 0.187" HD x 1 1/2" long ringshank nails are used for fastening HardieShingle® Half-Round Panels to both framing and to 7/16" thick APA rated sheathing.

HardieShingle Half-Round Panel Installation

Install HardieShingle® panels with joints butted in moderate contact. Due to overlapping of the joints, caulk is not required except where panels abut trim boards. (fig. 18). Ensure keyways do not line up on subsequent courses.

- 1) Install a 1-1/4" starter strip, then install a 8-1/4" wide HardiePlank® lap siding starter course.
- 2) Place first panel so that panel end centers over stud. Trim panel as needed. Butt the cut end into trim as shown (figs 18). When installing over a band board or any horizontal surface, leave 1/4" gap between bottom of siding and flashing.
- 3) Secure panel, leaving 1/8" gap for caulk at trim and continue the course along the wall.
- 4) Start the second course, by removing the equivalent of one full stud cavity (16" or 24" OC), again abutting the cut end into the trim (fig 18). This is to prevent pattern repetition. Repeat step 3.
- 5) Start the third course, by removing the equivalent of two full stud cavities (figs 13 & 15) and repeat step 3.
- 6) Continue up the wall repeating steps 2 through 6 until desired height is reached.

Figure 18

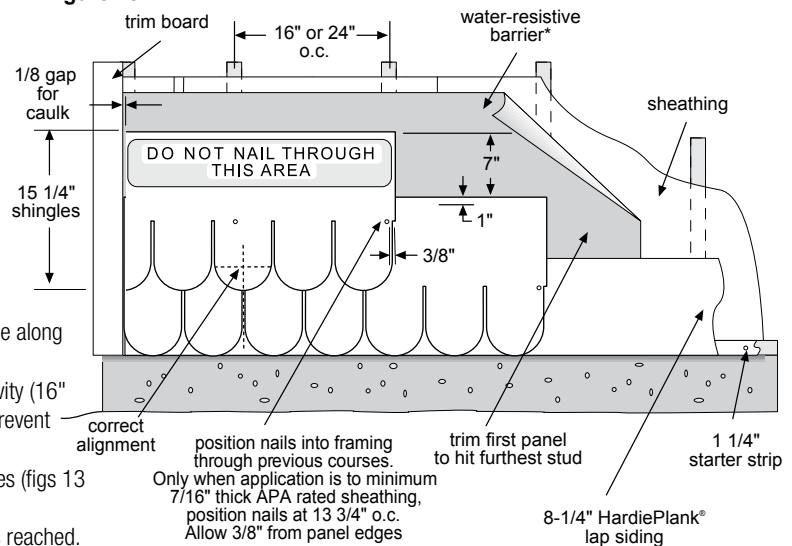

HARDIESHINGLE HALF-ROUND PANEL COVERAGE

Panels for sidewall applications are available in 48" lengths. Pieces needed for one square (100 sq. ft.) of product coverage=43 pieces with 7" exposure.

CORNER DETAILS

- A. Panels butted against corner boards.
- B. Panels butted against square wood strip on inside corner, flashing behind.
- C. Laced outside corner.
- D. Laced inside corner.

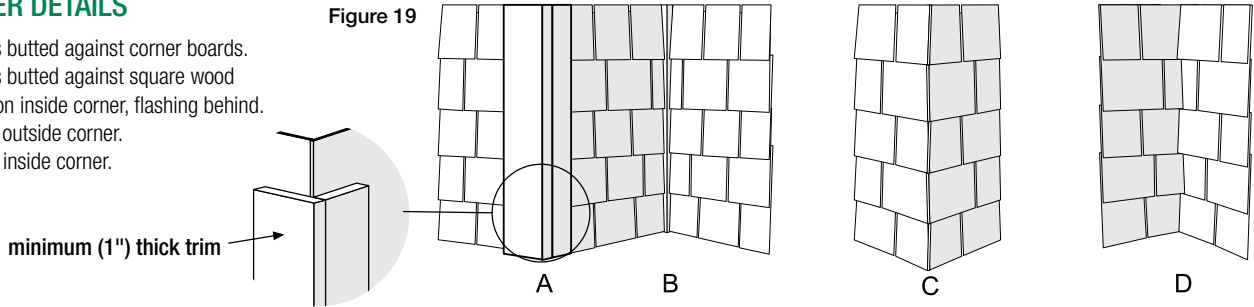

WINDOWS AND DOORS

Building wall components such as windows, doors and other exterior wall penetrations shall be installed in accordance with the component manufacturer's written installation instructions and local building codes. Where windows or doors are installed, continue the application of siding as if the wall is complete. Trimming for the opening and using the resulting piece may throw off the spacing above the break.

GENERAL FASTENING REQUIREMENTS

Fasteners must be corrosion resistant, galvanized, or stainless steel. Electro-galvanized are acceptable but may exhibit premature corrosion. James Hardie recommends the use of quality, hot-dipped galvanized nails. James Hardie is not responsible for the corrosion resistance of fasteners. Stainless steel fasteners are recommended when installing James Hardie® products near the ocean, large bodies of water, or in very humid climates.

- Consult applicable product evaluation or listing for correct fasteners type and placement to achieve specified design wind loads.
- NOTE: Published wind loads may not be applicable to all areas where Local Building Codes have specific jurisdiction. Consult James Hardie Technical Services if you are unsure of applicable compliance documentation.
- Drive fasteners perpendicular to siding and framing.
- Fastener heads should fit snug against siding (no air space). (fig. A)
- Do not over-drive nail heads or drive nails at an angle.
- If nail is countersunk, fill nail hole and add a nail. (fig. B)
- For wood framing, under driven nails should be hit flush to the plank with a hammer (For steel framing, remove and replace nail).
- **Do not use aluminum fasteners, staples, or clipped head nails.**

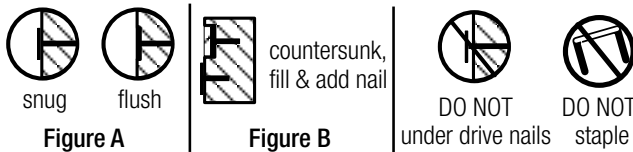

PNEUMATIC FASTENING

James Hardie products can be hand nailed or fastened with a pneumatic tool. Pneumatic fastening is highly recommended. Set air pressure so that the fastener is driven snug with the surface of the siding. A flush mount attachment on the pneumatic tool is recommended. This will help control the depth the nail is driven. If setting the nail depth proves difficult, choose a setting that under drives the nail. (Drive under driven nails snug with a smooth faced hammer - Does not apply for installation to steel framing).

CUT EDGE TREATMENT

Caulk, paint or prime all field cut edges. James Hardie touch-up kits are required to touch-up ColorPlus products.

CAULKING

For best results use an Elastomeric Joint Sealant complying with ASTM C920 Grade NS, Class 25 or higher or a Latex Joint Sealant complying with ASTM C834. Caulking/Sealant must be applied in accordance with the caulking/sealant manufacturer's written instructions. **Note: OSI Quad as well as some other caulking manufacturers DO NOT allow tooling.**

PRIMING & PAINTING

DO NOT use stain, oil/alkyd base paint, or powder coating on James Hardie® Products. James Hardie® products must be painted within 180 days for primed product and 90 days for unprimed. In addition non ColorPlus® product versions of HardieShingle® Siding require a field applied prime coat. 100% acrylic primers and topcoats are recommended. Do not paint when wet. For application rates refer to paint manufacturers specifications. Back rolling is recommended when paint is spray applied.

COLORPLUS® TECHNOLOGY CAULKING, TOUCH-UP & LAMINATE

- Care should be taken when handling and cutting James Hardie ColorPlus products. During installation use a wet soft cloth or soft brush to gently wipe off any residue or construction dust left on the product, then rinse with a garden hose.
- Touch up nicks, scrapes and nail heads using the ColorPlus® Technology touch up applicator. Touch-up should be used sparingly. If large areas require touch-up, replace the damaged area with new HardieShingle® siding with ColorPlus Technology.
- Laminate sheet must be removed immediately after installation of each course.
- Terminate non-factory cut edges into trim where possible, and caulk. Color matched caulks are available from your ColorPlus® product dealer.
- Treat all other non-factory cut edges using the ColorPlus Technology edge coat, available from your ColorPlus product dealer.

Note: James Hardie does not warrant the usage of third party touch-up or paints used as touch-up on James Hardie ColorPlus products.

Problems with appearance or performance arising from use of third party touch-up paints or paints used as touch-up that are not James Hardie touch-up, will not be covered under the James Hardie ColorPlus Limited Finish Warranty.

PAINTING JAMES HARDIE® SIDING AND TRIM PRODUCTS WITH COLORPLUS® TECHNOLOGY

When repainting ColorPlus products, James Hardie recommends the following regarding surface preparation and topcoat application:

- Ensure the surface is clean, dry, and free of any dust, dirt, or mildew
- Repriming is normally not necessary
- 100% acrylic topcoats are recommended
- DO NOT use stain, oil/alkyd base paint, or powder coating on James Hardie® Products.
- Apply finish coat in accordance with paint manufacturers written instructions regarding coverage, application methods, and application temperature
- DO NOT caulk nail heads when using ColorPlus products, refer to the ColorPlus touch-up section

5" EXPOSURE HARDIESHINGLE® STRAIGHT EDGE PANELS INSTALLATION (For 7" exposure product please go to page 3)

Maximum Exposure of 5"

REFER TO STAGGERED EDGE INSTRUCTIONS ON PAGE 3

Steps 1 - 4

Figure 20

Steps 5 & 6

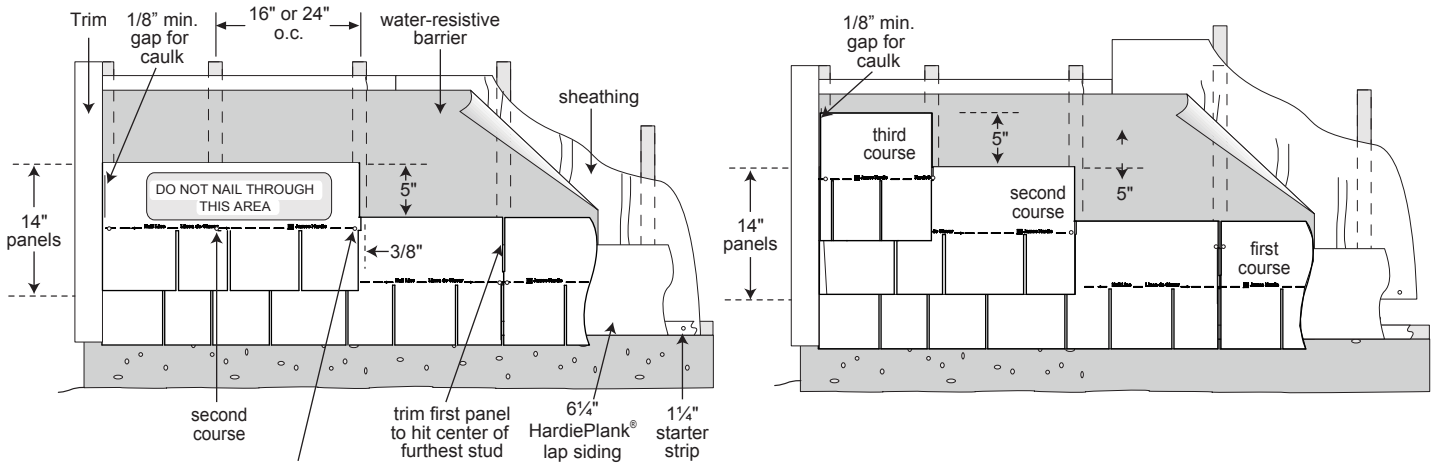

position nails on nail line and secure into framing. Only when application is to minimum 7/16" thick APA rated sheathing, position nails on nail line spaced a maximum of 13 3/4" o.c. Allow 3/8" from panel edges.

HARDIESHINGLE® STRAIGHT EDGE PANEL COVERAGE

Panels for sidewall applications are available in 48" lengths. Pieces needed for one square (100sq.ft.) of product coverage = approximately 60, based on maximum 5" exposure.

HARDIESHINGLE® INDIVIDUAL SHINGLE INSTALLATION

HardieShingle® Individual Shingles must be installed with the widest part of the shingle placed downwards and directly to minimum 7/16" thick sheathing.

Fastener Requirements

0.091" x 0.221" HD x 1 1/2" or 0.121" x 0.371" HD x 1 1/4" long corrosion resistant siding nails are used for fixing HardieShingle siding to 7/16" thick APA rated sheathing.

HardieShingle® Individual Shingle Installation

Due to overlapping of the joints, caulk is not required except where panels butt trim boards. Space shingles a maximum 1/4" apart and leave a min. lap of 1 1/2" between successive courses (fig. 17).

- 1) Install 1 1/4" starter strip and a 6 1/4" wide HardiePlank® siding starter course.
- 2) Install first shingle from the end abutting the trim. Install widest part of shingle placed downwards. (fig. 16).
- 3) Secure shingle, leaving a 1/8" gap for caulk at trim and continue the course along the wall.
- 4) Start the second course, leaving a minimum lap of 1 1/2" between successive courses, again from the end abutting the trim. Repeat step 3.
- 5) Continue up the wall repeating steps 2 through 5 until desired height is reached.

5" EXPOSURE HARDIESHINGLE® INDIVIDUAL SHINGLE COVERAGE

Individual Shingles for sidewall applications are available in assorted widths as listed below. Bundles needed for one square (100 sq. ft.) of product coverage:

Shingle Width	Number of Bundles	Pieces per Bundle
3-1/2"	3	20
4-1/2"	6	20
5-1/2"	6	20
7"	6	20
8-3/4"	3	20

Figure 16

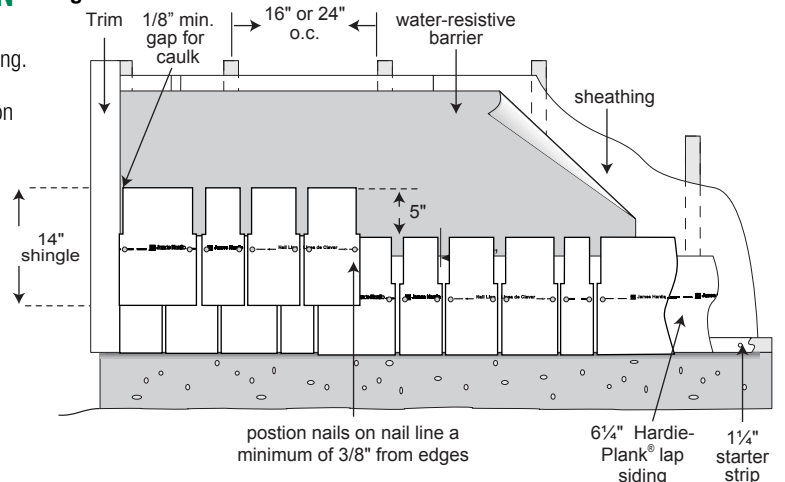
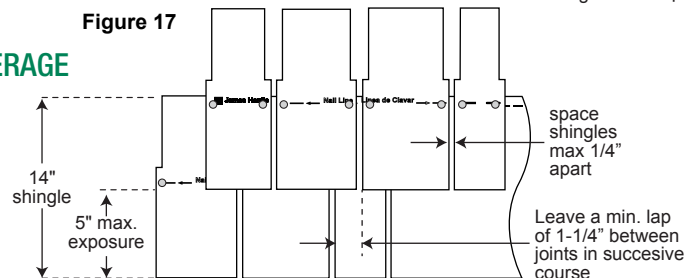

Figure 17



Install with the widest part of the shingle placed downwards

RECOGNITION: In accordance with ICC-ES Evaluation Report ESR-2290, HardieShingle lap siding is recognized as a suitable alternate to that specified in: the 2006, 2009, & 2012 International Residential Code for One- and Two-Family Dwellings, and the 2006, 2009, & 2012 International Building Code. HardieShingle lap siding is also recognized for application in the following: City of Los Angeles Research Report No. 24862, State of Florida listing FL#889, Dade County, Florida NOA No. 02-0729.02, U.S. Dept. of HUD Materials Release 1263c, Texas Department of Insurance Product Evaluation EC-23, City of New York MEA 223-93-M, and California DSA PA-019. These documents should also be consulted for additional information concerning the suitability of this product for specific applications