



## James Hardie® Siding Products

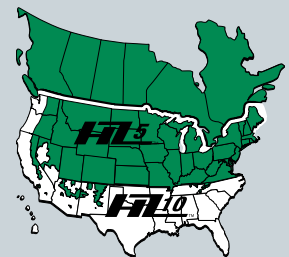
### Best Practices – Installation Guide Siding and Trim Products

Version 9.1 - December 2019

**FL5**®

Engineered for Climate®

- HardiePlank®
- HardieShingle®
- HardiePanel®
- HardieTrim®
- HardieSoffit®



 **JamesHardie**™

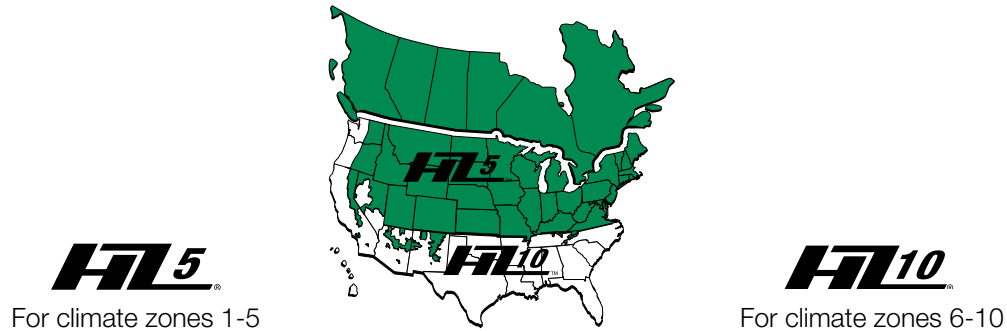
**ColorPlus**® Technology

## HardieZone® – Engineered for Climate®

James Hardie, the undisputed leader in fiber cement has always made the world's most resilient siding, and now we have made it even better. For the first time, siding has been engineered for climate. So you get the right board for the right climate. We call it the HardieZone® System.

We took the 8 climatic variables – that affect long term performance of the exterior into account and by combining them determined climate zones throughout North America. We found common variables between certain zones which led us to engineer James Hardie siding products for specific climates.

The development of these two products is a result of a heavy investment in R&D and our proprietary technology and manufacturing processes and culminates in the evolution of 7th generation fiber cement – Engineered for Climate.



The HZ5® products are specifically engineered to perform in climates with seasonal temperature variations, freezing temperatures and snow and ice.

The HZ10® products are specifically engineered to perform in climates with, high humidity, hot dry conditions and high levels of rainfall.

This guide provides the best practice guidelines for installing the HardieZone product for your zone. Specific details and helpful hints that pertain to your zones are included in order to facilitate your installation process. If you are unsure about which zone your job is located in and which HardieZone product and installation instructions to use, then please visit our website at [jameshardie.com](http://jameshardie.com) for the zip code tool.



### FOREWORD

James Hardie, the world leader in the manufacturing and development of fiber-cement building products, has produced this Installation Guide to help builders and contractors with the installation of James Hardie® siding and trim products, including James Hardie products with ColorPlus® Technology.

The first sections of this manual provide a general product description and information about safe practices, and proper tools for working with James Hardie siding and trim products. Sections that follow describe design and general installation information for specific James Hardie products. The appendix addresses the installation of James Hardie siding products in less common construction practices (e.g. concrete construction).

This manual must be read in conjunction with project drawings and specifications, applicable building codes, and relevant compliance documents. The details in this manual provide guidance on how to comply with James Hardie's installation requirements and need to be reviewed by all parties who are responsible for installing James Hardie products on a project.

**This manual is subject to periodic re-examination and revision. For information on the current status of these documents please check the James Hardie website, [www.jameshardie.com](http://www.jameshardie.com). The reader is responsible for ensuring that they are using the most up-to-date information.**

### TELEPHONE DIRECTORY

**Technical Services** 800-942-7343

**Warranty** 866-375-8603



# Table of Contents

<b>FOREWORD</b> .....	<b>3</b>	Butting to Mortar or Masonry.....	21
<b>GENERAL PRODUCT INFORMATION</b> .....	<b>6</b>	Clearances .....	21
Jobsite Storage of James Hardie® Products .....	6	Siding to Ground Clearance.....	22
Importance of Keeping James Hardie Products Dry.....	6	Siding to Flashing Clearance .....	22
Open Joints Due to Shrinkage.....	6	Siding and Trim to Solid Surfaces .....	23
Difficulty in Handling .....	6	Clearances for Sheltered Areas.....	23
Staining .....	6	Clearance Requirement Examples .....	24-26
Proper Handling of James Hardie Products .....	7		
<b>WORKING SAFELY WITH JAMES HARDIE PRODUCTS</b> .....	<b>8</b>	<b>GENERAL FASTENER REQUIREMENTS</b> .....	<b>27</b>
Minimize and Manage Silica Dust .....	8	Pneumatic Fastening .....	27
Work Safe: Product Cutting Instructions .....	8	<b>FINISHING</b> .....	<b>28</b>
Cutting Station Set Up.....	9	Finishing James Hardie® Siding and Trim Products .....	28
Clean Up and Disposal of Debris .....	9	ColorPlus® Touch-Up.....	28
		ColorPlus Products with Protective Laminate Sheet.....	29
		Caulk.....	29
		Repair Patching.....	29
		Back Priming/Back Sealing .....	29
		Maintenance.....	30-31
<b>TOOLS FOR CUTTING AND FASTENING FIBER-CEMENT</b> .....	<b>10</b>		
Shears.....	10	<b>HardieWrap®</b>	
Circular Saws .....	10	<b>HARDIEWRAP® PRODUCTS DESCRIPTION</b> .....	<b>32</b>
Hepa Vacuums.....	11	<b>INSTALLATION OF HARDIE WRAPS</b> .....	<b>33</b>
Power Miter Saws .....	11	HardieWrap® Flashing Guide for Typical Penetration .....	34
Saw Blades .....	11	HardieWrap® Pro-Flashing Guide for Windows .....	34
Jig Saws .....	12	Storage .....	35
Drilling Fiber Cement .....	12	General Requirement.....	35
Lap Gauges.....	12	HardieWrap® Flex Flashing Stretchable Sill Flashing.....	36
Joint Flashing .....	13	Window Installation.....	36
Power Nailers and Direct-to-Steel Fastening Tools.....	13	Side Jamb Flashing .....	37
Nail Guns and ET&F Guns .....	14	Head Flashing .....	37
Useful Hand Tools .....	14	Circular Windows .....	38
		HardieWrap® Installation Requirements.....	39-44
<b>GENERAL INSTALLATION REQUIREMENTS</b> .....	<b>15</b>		
Framing and Sheathing.....	16	<b>HardieTrim®</b>	
Water-Resistive Barrier .....	17	<b>HARDIETRIM® PRODUCTS DESCRIPTION</b> .....	<b>45</b>
Staging.....	17	<b>INSTALLATION OF HARDIETRIM 4/4, 5/4 &amp; NT3™ BOARDS</b> .....	<b>46</b>
Flashing.....	17	Concealed Fastening.....	46
Roof-to-Wall Flashing .....	18	Trimming Corners.....	46
Gutters .....	18	Trim Applications for Windows, Door & Other Openings .....	47
Valley Flashing .....	19	Band Boards .....	47
Penetrations .....	19		
Hose Bibs .....	20		
Hot Air Vents .....	20		
Lights and Electrical Outlets .....	21		
Wires, Conduits or Other Fixed Pipes .....	21		
Air Conditioners, Service Panels and Other Wall Mounted Devices .....	21		



Fastener Table .....	48
Outside Corners .....	49
Inside Corners .....	49
Band Board .....	50
HardieTrim Board Fastener Specifications .....	50
Window and Door Trim .....	51
Installing Rake and Fascia Board .....	52
Drip Edge .....	52

**INSTALLATION OF HARDIETRIM® BATTENS.....53**

Getting Started .....	53
HardieTrim Battens Fastener Specifications .....	53
Horizontal Joint Treatment .....	54
5/4 & 4/4 HardieTrim HZ10® Installation Requirements .....	55-63
5/4 & 4/4 HardieTrim HZ® Installation Requirements .....	64-72

**HardieSoffit®**

**HARDIESOFFIT® PANEL PRODUCT DESCRIPTION.....73**

**INSTALLATION OF HARDIESOFFIT® PANELS.....74**

Installation of HardieSoffit Panels – Soffit Framing .....	74
Joint Treatment for HardieSoffit Panels .....	74
Framing Prep for Soffit Panels .....	75
Cutting 45° Hip Roof Soffits .....	75
Installing Frieze Boards .....	76
Treatment Options for the Siding/Soffit Juncture .....	76
Insect Screen .....	76
HardieSoffit Fastener Specifications .....	76
Beaded Porch Panel Framing .....	77
Joint Treatment for Beaded Porch Panel .....	77
Handling During Installation .....	78
Siding Beaded Porch Panel Joint .....	78
HardieSoffit Panels Installation Requirements .....	79-81
HardieSoffit Beaded Porch Panel Installation Requirements .....	82-84

**HardiePlank®**

**HARDIEPLANK® LAP SIDING PRODUCT DESCRIPTION.....85**

**INSTALLATION OF HARDIEPLANK LAP SIDING .....86**

Install a Starter Strip .....	86
Installing the Planks .....	87
Plank Alignment at Corners .....	87
Handling .....	87
Blind Nailing .....	88

Face Nailing .....	88
Staggering the Butt Joints .....	88
Joint Flashing .....	89
Joint Placement and Treatment .....	89
Continuing the Installation .....	90
Installing HardiePlank Siding on Gable Walls .....	90-91
HardiePlank Siding Fastener Specifications .....	91
HardiePlank Lap Siding Installation Requirements .....	92-95

**HardieShingle®**

**HARDIESHINGLE® SIDING PRODUCT DESCRIPTION.....96**

**INSTALLATION OF HARDIESHINGLE SIDING.....97**

Individual Shingles .....	97
Shingle Fastener Specifications .....	97
Shingle Panels .....	98
Installing Direct to 7/16 in Sheathing .....	99
Half-Round Shingle Panels .....	99-100
HardieShingle Siding Installation Requirements .....	101-108

**HardiePanel®**

**HARDIEPANEL® VERTICAL SIDING PRODUCT DESCRIPTION.....109**

**INSTALLATION OF HARDIEPANEL VERTICAL SIDING .....110**

Getting Started .....	110
Vertical Joint Treatment .....	111
HardiePanel Siding Fastener Specifications .....	111
Horizontal Joint Treatment .....	112
Windows, Doors, and Other Wall Penetrations .....	113
HardiePanel Vertical Siding Installation Requirements .....	114-116

**APPENDIX A – ADDITIONAL INFORMATION ..... 117-123**

**APPENDIX B – ESTIMATING..... 124-126**

**APPENDIX C – GLOSSARY OF BUILDING TERMS..... 127-128**

**APPENDIX D – CODE REFERENCES ..... 129**

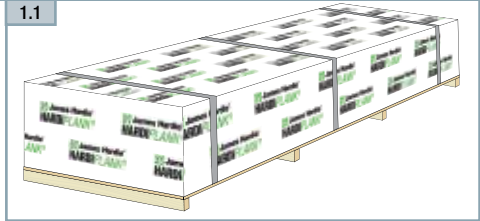
**ESR-1844 & ESR-2290 ONLINE REPORTS..... 130**

# General Product Information

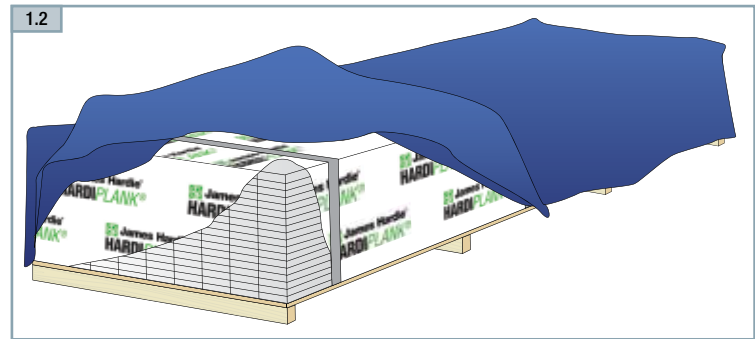
## JOBSITE STORAGE OF JAMES HARDIE® PRODUCTS

The James Hardie family of siding and trim products, including James Hardie® products with ColorPlus® Technology, should be stored in their original packaging in a garage, shed, or in some other covered area protected from weather whenever possible. These products must be kept covered on a pallet off of the ground; they must never be stored in direct contact with the ground.

If James Hardie products are stored outside they should be protected with an additional waterproof covering. All scrap siding and trim pieces, cutoffs or material left on scaffolding must be covered and protected from the elements. If James Hardie products become saturated, they must be laid on a flat surface and allowed to dry completely prior to installation.



1.1 James Hardie products stored in their original packaging.



1.2 If stored outside protect with an additional waterproof covering.

**WARNING**

James Hardie products should not be rolled-off or dumped-off of the truck during delivery to the jobsite. James Hardie recommends using a fork lift to off load material or unloading by hand.

## IMPORTANCE OF KEEPING JAMES HARDIE PRODUCTS DRY

James Hardie siding and trim products must be kept dry at all times prior to installation. If products become saturated before they are installed, the following problems may occur:

### OPEN JOINTS DUE TO SHRINKAGE

If installed wet, joints between planks may open up requiring repair or replacement. Under normal environmental conditions fiber cement has significantly greater dimensional stability than wood or vinyl-based exterior products.

### DIFFICULTY IN HANDLING

Saturation increases the weight and flexibility of fiber-cement products, making them difficult to handle.

### STAINING

Staining is a deposit of soluble salts, usually white in color, which sometimes appears on the surface of masonry or concrete construction.

**WARNING**

James Hardie is not responsible for damage due to improper storage and handling of its products.

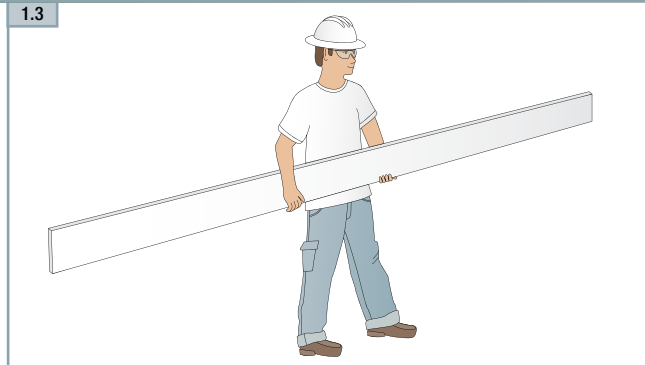


## PROPER HANDLING OF JAMES HARDIE® PRODUCTS

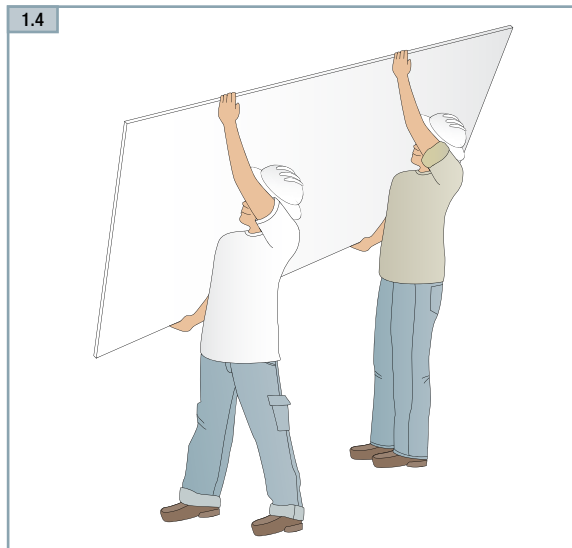
To help avoid injury and product damage, lap siding, trim and soffit material should always be carried on edge. James Hardie recommends that these products be carried by two people whenever possible with each person positioned near the end of the load. To carry a plank solo, a person should hold it on edge in the middle with arms spread apart for maximum support of the product. Lifting or carrying lap siding or trim flat may break or bend the product.

James Hardie recommends that two people always carry panel products. Workers should hold the panel near each end and on edge. Because of reduced visibility when handling panel products, take extra care to avoid damaging the corners and edges of the panel.

**TIP:** When handling panel products, manufactured panel carriers or caddies can give workers better control.



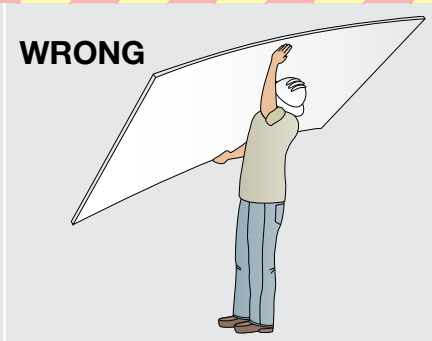
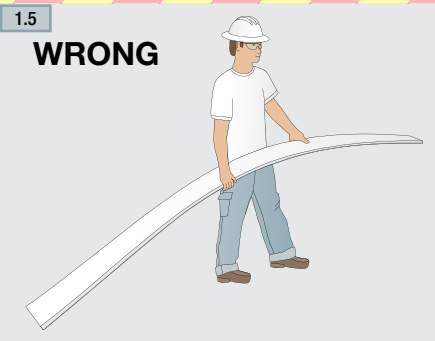
**1.3**  
One person should hold planks on edge in the middle with arms spread apart for maximum support of the product



**1.4**  
Two people should always carry panel products.

## WARNING

Carrying James Hardie® ColorPlus® siding products flat may cause excessive bending, which can damage the finish.



# Working Safely with James Hardie® Products

## MINIMIZE AND MANAGE SILICA DUST

Silica is the most common mineral found on earth. It is the main component of beach sand and is used to make glass and household products such as cleansers and polishes. Silica is also found in many everyday building materials: tile, concrete, granite countertops, drywall compound, masonry bricks, pavers, etc. It is a very durable material and contributes to the stability of fiber cement. Cutting or grinding silica containing materials with high speed saws or grinders can generate very fine (respirable) dust. Over time, long-term occupational over-exposure to respirable silica dust can cause lung diseases including silicosis, lung cancer and other health issues.









OSHA sets exposure limits for dust, chemicals and other materials that employees may be exposed to at work or on a jobsite. These exposure limits cover dust from all types of materials, including: stone, brick, concrete, drywall, wood, and wood composites. OSHA requires employers to take specific actions to protect workers on construction sites based on the amount of silica dust they are exposed to. The updated OSHA standard reduces the permissible exposure limit (PEL) for silica dust by about 80% – from 250 µg/m<sup>3</sup> to 50 µg/m<sup>3</sup> – over an 8-hour period.

If you have concerns about dust exposure or compliance with OSHA regulations, please contact James Hardie at 1-800-942-7343, or consult with a qualified industrial hygienist (IH). A directory of independent IH consultants can be found at [www.aiha.org](http://www.aiha.org).

## WORK SAFE: FOLLOW JAMES HARDIE PRODUCT CUTTING INSTRUCTIONS

### OUTDOORS

1. Position cutting station so that airflow blows dust away from the user and others near the cutting area.
2. Cut using one of the following methods:
  - a. Best: Circular saw equipped with a HardieBlade® saw blade and attached vacuum dust collection system. Shears (manual, pneumatic or electric) may also be used (not recommended for products thicker than 7/16 in.)
  - b. Better: Circular saw equipped with a dust collection feature and a HardieBlade saw blade.
  - c. Good: Circular saw equipped with a HardieBlade saw blade

Best	 Shears		
	 Circular Saw with vacuum adapter	 HardieBlade® Saw Blade	 Vacuum
	 Dust Collecting Circular Saw	 HardieBlade® Saw Blade	
Good*	 Circular Saw	 HardieBlade® Saw Blade	

### INDOORS

DO NOT grind or cut with a power saw indoors. Cut using shears (manual, pneumatic or electric) or the score and snap method (not recommended for products thicker than 7/16 in.)

\*May require proof of compliance (industry reports or exposure testing)



James Hardie ranks options for cutting our fiber cement products in a convenient "Good, Better, Best" chart. The chart on the previous page is provided for informational purposes only to help you in selecting the appropriate cutting options for your particular circumstances. If you are unsure which cutting tools are best for your job site, consult a qualified industrial hygienist or safety professional, or contact your James Hardie representative for assistance.

The Occupational Safety and Health Administration (OSHA) regulates workplace exposure to silica dust. For construction sites, OSHA has deemed that cutting fiber cement outdoors with a circular saw having a blade diameter less than 8 inches and connected to a commercially available dust collection system per manufacturer's instructions results in exposures below the OSHA Permissible Exposure Limit (PEL) for respirable crystalline silica, without the need for additional respiratory protection.

Note: James Hardie makes no representation or warranty that use of a particular cutting option will assure your compliance with OSHA rules or applicable laws and safety requirements.

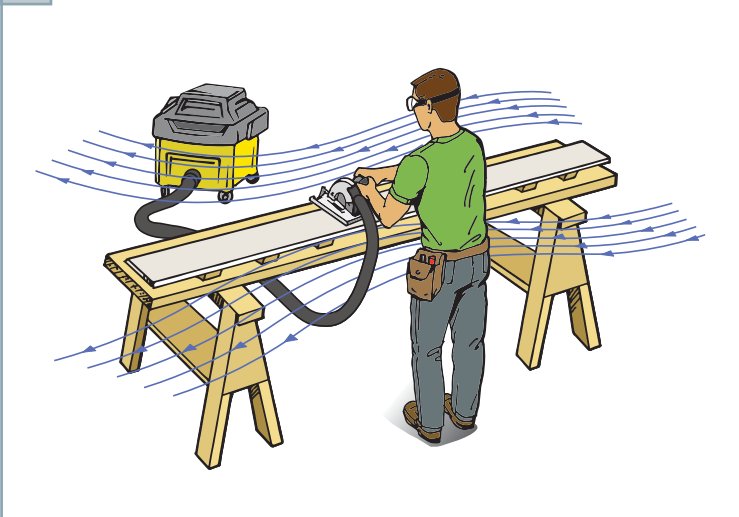
## CUTTING STATION SET UP

Set up cutting tables or workstations in well ventilated outdoor areas, downwind from other workers. Do not cut indoors or in enclosed areas with high speed saws unless special precautions are taken to prevent overexposure to dust.

### Clean Up and Disposal of Debris

When cleaning up dust and debris from cutting James Hardie® products, never use a broom or brush if the debris material is dry. Use wet dust suppressions methods, sweeping compound, or use a vacuum to collect dust. Waste pieces of James Hardie siding and trim products can be disposed of in landfills according to local ordinances. No special handling is required.

2.1



### SILICA WARNING

**DANGER:** May cause cancer if dust from product is inhaled. Causes damage to lungs and respiratory system through prolonged or repeated inhalation of dust from product. Refer to the current product Safety Data Sheet before use. The hazard associated with fiber cement arises from crystalline silica present in the dust generated by activities such as cutting, machining, drilling, routing, sawing, crushing, or otherwise abrading fiber cement, and when cleaning up, disposing of or moving the dust. When doing any of these activities in a manner that generates dust you must (1) comply with the OSHA standard for silica dust and/or other applicable law, (2) follow James Hardie cutting instructions to reduce or limit the release of dust; (3) warn others in the area to avoid breathing the dust; (4) when using mechanical saw or high speed cutting tools, work outdoors and use dust collection equipment; and (5) if no other dust controls are available, wear a dust mask or respirator that meets NIOSH requirements (e.g. N-95 dust mask). During clean-up, use a well maintained vacuum and filter appropriate for capturing fine (respirable) dust or use wet clean-up methods - never dry sweep.

**WARNING:** This product can expose you to chemicals including respirable crystalline silica, which is known to the State of California to cause cancer. For more information go to [P65Warnings.ca.gov](http://P65Warnings.ca.gov).

# Tools for Cutting and Fastening Fiber-Cement Products

James Hardie promotes certain tools and products for the safest and best way to cut their fiber-cement products, consistent with its best practice recommendations (please refer to page 6-7). However, please consult tool manufacturer instructions and guidelines for the safe operation of specific tools. The tools listed here are not made for, or by, James Hardie Building Products, Inc. and James Hardie accepts no liability for their use or misuse.

## SHEARS

Because shears produce less dust than high-speed tools, they are the preferred method of cutting lap and panel siding products. Both electric and pneumatic shears are available, and they may be used for cutting indoors as well as outdoors. Shears are available that can make straight or radius cuts in fiber cement products with relative ease. Shears cannot be used to cut HardieTrim® boards.



**TIP:** For the smoothest cuts, when cutting James Hardie® siding products with a shear or circular saw, cut the board face down. When using a miter saw, cut the board face up. If installing James Hardie siding products with ColorPlus® Technology, leave the protective laminate film in place while cutting.

## CIRCULAR SAWS

When cutting any James Hardie siding, soffit, or trim product with a circular saw, use only tools that are designed specifically for dust reduction. A dust-reducing circular saw has either a deflector to direct any dust away from the user's breathing area or a collection box to capture the dust. James Hardie recommends that a HEPA-equipped vacuum system be used in conjunction with any circular saw. (Circular saws should only be used in outdoor, well-ventilated areas.)



## WARNING

Always make sure the saw manufacturer's safety equipment is in place and in good working order. Never use high-speed power tools when cutting James Hardie® products indoors.

## HEPA VACUUMS

Always use a vacuum equipped with a HEPA filter to help minimize the amount of respirable dust during power saw cutting and clean-up. Many vacuums are designed to connect directly to power tools and run only when the power tool is being operated. In addition to a HEPA filter, using a disposable drywall or collection bag is recommended to extend the life of the HEPA filter and make disposal easier and safer.



## POWER MITER SAWS

Like circular saws, a power miter saw should only be operated outdoors in well-ventilated areas. Power miter saws should be equipped with a HardieBlade® saw blade and should be used in conjunction with a vacuum equipped with a HEPA filter for maximum dust protection.



## SAW BLADES

Traditional blades that are not designed for cutting James Hardie products may generate excessive dust, cut slowly, or exhibit premature wear. The HardieBlade® saw blade is a unique circular saw blade designed to generate less respirable dust than a traditional saw blade or continuous rim diamond blade. The HardieBlade can also be used to cut the full line of James Hardie products and are available in 7 1/4 in., 10 in., and 12 in. diameters. To extend the life of a HardieBlade saw blade, do not use it to cut any materials other than fiber cement.



# Tools for Cutting and Fastening Fiber-Cement Products (cont.)

## JIG SAWS

Jig saws equipped with a fiber-cement cutting blade may be used to cut service openings, curves, radii, scrollwork, and other irregular shapes in James Hardie® products. Because most jig saws are not equipped with dust collection capabilities, these tools also should only be used outdoors in well-ventilated areas and for limited amounts of cutting.



## DRILLING FIBER CEMENT

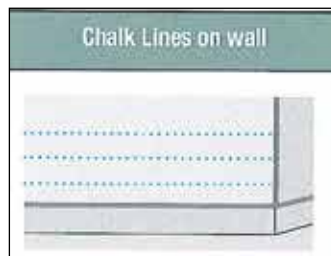
When required to drill a hole in fiber cement products, a masonry bit should be used. For larger holes, a carbide tipped hole saw can be used. Due to the lack of dust collection, drills and hole saws should only be used outdoors in well-ventilated areas and for limited amounts of cutting. For best results, use a hole saw specifically designed for fiber cement.



[www.malcoproducts.com](http://www.malcoproducts.com)

## LAP GAUGES

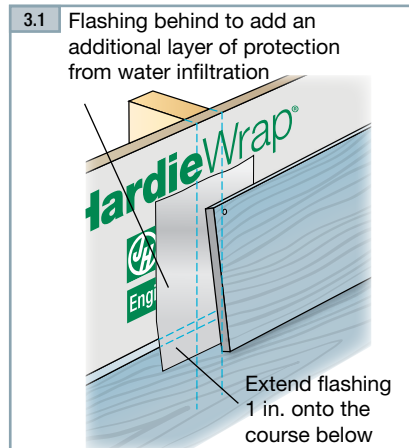
Several different methods exist to ensure proper spacing and overlap of fiber cement products. The slowest method is to snap a chalk line with the proper spacing above each row of fiber cement as it is being installed. The siding gauge leads all other alignment devices in ease of use, speed, and effectiveness. James Hardie recommends the use of siding gauge when installing lap siding. When installing HZ5®, special care must be taken when using lap gauges so the drip edge is not damaged. For best results, use a Siding Gauge that is specifically designed for HZ5®.





## JOINT FLASHING

Flashing behind butt joints provides an extra level of protection against the entry of water at the joint. James Hardie recommends 6 in. wide flashing that overlaps the course below by 1 in. Some local building codes may require different size flashing. Joint-flashing material must be durable, waterproof materials that do not react with cement products. Examples of suitable material include finished coil stock and code compliant water-resistive barriers. Other products may also be suitable.



## POWER NAILERS AND DIRECT-TO-STEEL FASTENING TOOLS

Pneumatic nailers and cordless nailers can be used to attach James Hardie products to wood, steel, or masonry substrates. Pneumatic tools require the use of an air compressor with a hose. Finish nailers should be used for HardieTrim® boards only. Additionally, direct-to-steel tools such as those made by ET&F are designed specifically for fastening to steel framing. Refer to the product-specific installation instructions in each section for fastener choices.

Power nailers recommended for attaching James Hardie products are siding nailers, roofing nailers and finish nailers. Below is a chart showing the appropriate nailer for each of the James Hardie siding and trim products. Be sure that the nailer chosen fires the fastener recommended for each product for the specific installment situation.

### PNEUMATIC NAILER USAGE WITH JAMES HARDIE® PRODUCTS

#### Siding Guns



HardiePlank® Lap Siding  
 HardiePanel® Vertical Siding  
 HardieShingle® Panels  
 HardieSoffit® Panels

#### Roofing Guns



HardiePlank® Lap Siding  
 HardiePanel® Vertical Siding  
 HardieShingle® Panels

#### Finish Guns



HardieTrim® 5/4, 4/4 Boards  
 HardieTrim® Batten Boards

**TIP:** If framing nailers are used to install James Hardie products, be sure they are fitted with a flush mount attachment to control nail seating depth.

# Tools for Cutting and Fastening Fiber-Cement Products (cont.)

## NAIL & PIN GUNS

Pneumatic nail guns can be used to attach James Hardie products to wood, steel or masonry substrates. Finish nail guns can be used for HardieTrim® board only. Refer to the product specific installation instructions for fastener choices. Below are examples of commonly used nail guns.

Hitachi ([www.hitachipowertools.com](http://www.hitachipowertools.com))\*

(NT65A2) 2½ in. 16 gauge Finish Nailer  
(NV65AH) 2½ in. Siding Nailer  
(NV45AB2(S)) 1¾ in Coil Roofing Nailer  
(NV75AG) 3 in Coil Nailer

Dewalt ([www.dewalt.com](http://www.dewalt.com))\*

(D51257K) 1¼ in - 2½ in. 16 Gauge Straight Finish Nailer Kit

ET&F Fastening Systems ([www.etf-fastening.com](http://www.etf-fastening.com))\*

(500) Nailer to Steel Studs  
(510) Nailer to Steel Studs  
(610) Nailer to Steel Studs  
(110) Finish Nailer to Steel Studs

Duo-Fast ([www.duo-fast.com](http://www.duo-fast.com))\*

(P275C) Siding Coil Nailer

Porter Cable ([www.deltaportercable.com](http://www.deltaportercable.com))\*

(COIL250) 2½ in. Coil Nailer

Aerosmith ([www.AerosmithFastening.com](http://www.AerosmithFastening.com))

(ST4100/ST4200) Nailer to Steel Studs  
(HN120) Nailer to Masonry  
Requires special high pressure air compressor model number AKHL1050E



NV65AH



NT65A2



NV45AB2(S)



NV75AG



DC616KA†



P275C



ET&F 510



610 ET&F



110 ET&F



ST4100/  
ST4200



HN120

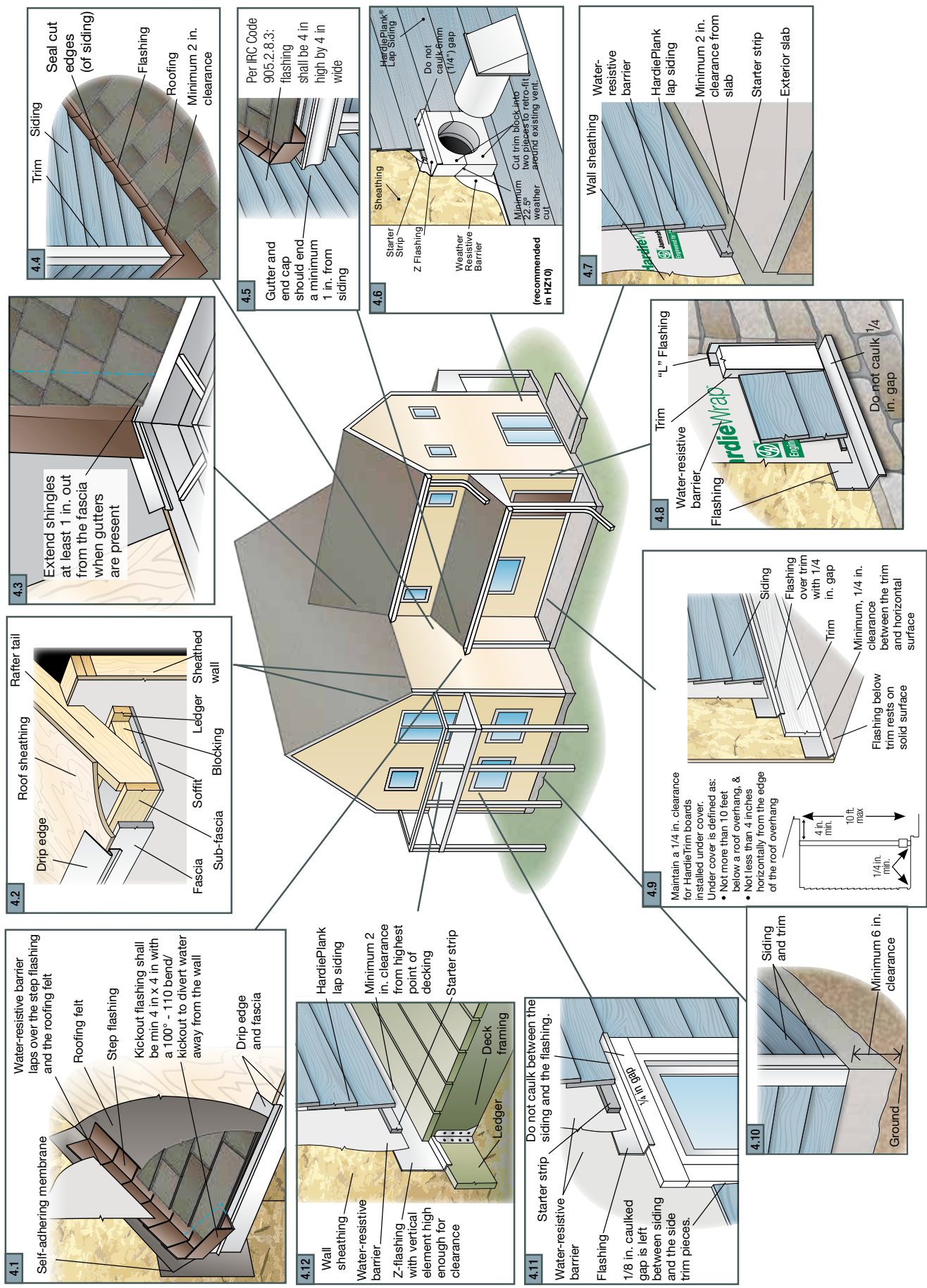
## USEFUL HAND TOOLS

In addition to the power tools listed above, certain hand tools are necessary for the installation of James Hardie® siding and trim products. These include:

- 25 ft. contractors tape measure
- Torpedo level
- Pencil or pen
- Smooth-faced hammer
- Speed square
- 4 ft. or longer level

**TIP:** If hand nailing, use a smooth faced hammer to avoid marking the product. Waffle-headed hammers should not be used when hand nailing James Hardie siding and trim products.

# General Installation Requirements



4.1

Self-adhering membrane  
Water-resistive barrier laps over the step flashing and the roofing felt  
Roofing felt  
Step flashing  
Kickout flashing shall be min 4 in x 4 in with a 100° - 110 bend/  
Kickout to divert water away from the wall  
Drip edge and fascia

4.2

Roof sheathing  
Rafter tail  
Drip edge  
Fascia  
Sub-fascia  
Soffit  
Blocking  
Ledger  
Sheathed wall

4.3

Extend shingles at least 1 in. out from the fascia when gutters are present

4.4

Trim  
Siding  
Seal cut edges (of siding)  
Flashing  
Roofing  
Minimum 2 in. clearance

4.5

Gutter and end cap should end a minimum 1 in. from siding

4.6

Per IRC Code 905.2.8.3; flashing shall be 4 in high by 4 in wide

4.7

HardiePlank® Lap Siding  
Do not caulk 1/4" gap  
Cut trim block into two pieces to retro-fit around existing vent.  
Minimum 22.5" weather cut

4.8

Water-resistive barrier  
HardiePlank lap siding  
Minimum 2 in. clearance from slab  
Starter strip  
Exterior slab

4.9

Maintain a 1/4 in. clearance for HardieTrim boards installed under cover.  
Under cover is defined as:  
• Not more than 10 feet below a roof overhang, &  
• Not less than 4 inches horizontally from the edge of the roof overhang

4.10

Minimum 1/4 in. clearance between the trim and horizontal surface  
Flashing below trim rests on solid surface

4.11

Do not caulk between the siding and the flashing.  
Starter strip  
Water-resistive barrier  
Flashing  
1/8 in. caulked gap is left between siding and the side trim pieces.

4.12

Wall sheathing  
Water-resistive barrier  
Z-flashing with vertical element high enough for clearance  
HardiePlank lap siding  
Minimum 2 in. clearance from highest point of decking  
Starter strip  
Deck framing  
Ledger

General Product Information

Working Safely

Tools for Cutting and Fastening

General Installation Requirements

General Fastener Requirements

Finishing and Maintenance

HardieWrap® Weather Barrier

HardieTrim® Boards/Battens

HardieSoffit® Panels

HardiePlank® Lap Siding

HardieShingle® Siding

HardiePanel® Vertical Siding

Appendix/Glossary

ESR-1844 & 2290 Report



# General Installation Requirements

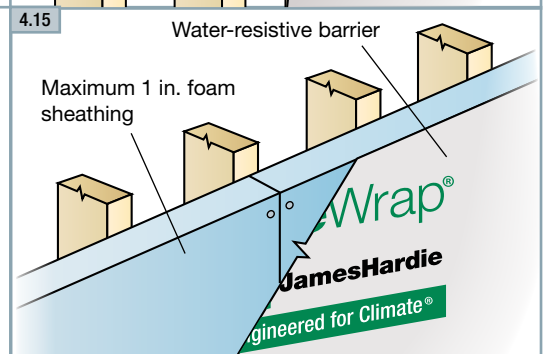
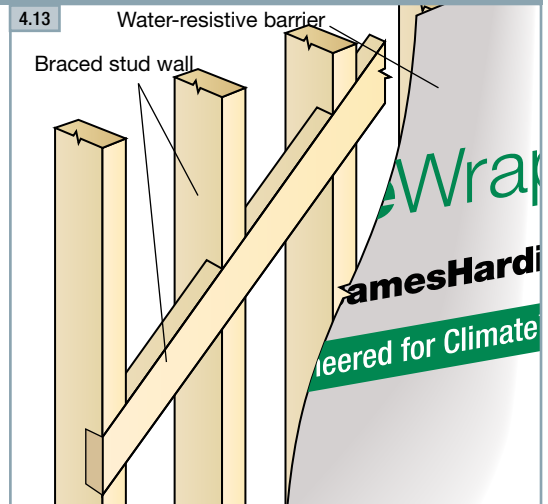
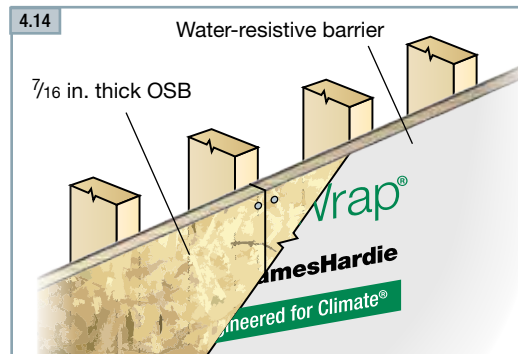
## FRAMING AND SHEATHING

Refer to the appendix for more information on rigid foam insulation.

James Hardie® siding and trim products can be installed over braced wood or steel studs spaced at a maximum of 24 in. on center or directly to 7/16 in. thick OSB or equivalent sheathing. These products can also be installed over solid-foam insulation board up to 1 inch thick.

Irregularities and unevenness in framing, sheathing, foam and other wall assembly components, including under driven nails, can telegraph through to the finished siding and trim. These irregularities should be corrected before the siding is installed.

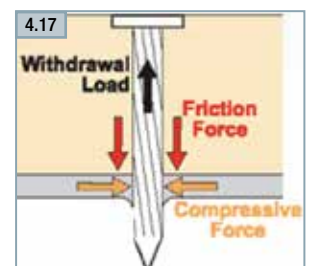
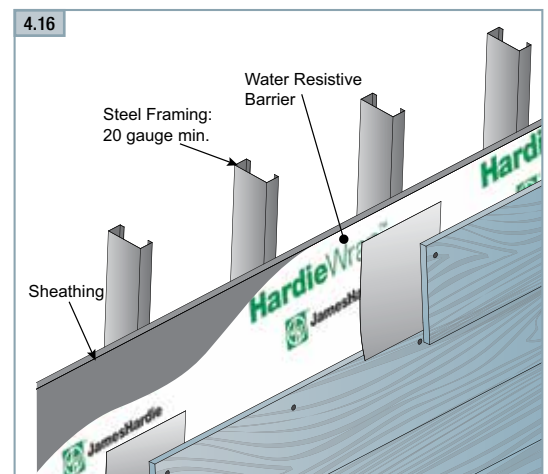
When installing James Hardie siding and trim products over steel studs James Hardie requires a minimum 20 gauge and recommends a maximum of 16 gauge. Steel framing that is outside of this range may be too flimsy to provide adequate holding power or too heavy for some fastening systems.



When using pins to attach siding products to steel, it is important to hold the material tight to the steel framing when driving the pin as the pin will not pull the material tight to the framing the same as a nail into wood will. Once the pin has been driven into the steel stud it is also important to not set or hit the nail a second time with a hammer. When driven into steel, the ballistic-shaped point uniformly pierces the steel instead of drilling it out or tearing the steel. The displaced steel rebounds around the pin to create a strong compressive force on the shank of the pin. When the pin is hit with a hammer it disrupts the compressive and frictional forces holding the pin and significantly reduces the overall holding capacity of the pin. If the pin does not set properly during the first attempt, the pin should be removed and replaced with a second pin.

When using a screw to attach James Hardie products to steel, a screw with a self tapping point should be used. A self tapping screw functions by having a cutting edge which drills away the material, making a tiny hole for the screw to go into. Some self tapping screws may be wing tipped which are intended to bore out the fiber cement (creating a pilot hole), and will break off as the screw goes into the steel. Either type of screw is acceptable for use.

Refer to the correct code compliance reports when selecting a fastener for steel applications and choose the corresponding tools from the tool section of this guide.



## WATER-RESISTIVE BARRIER

Prior to siding, make sure the water-resistive barrier is properly installed according to the manufacturers' instructions. Refer to page #30 for more information on HardieWrap® weather barrier including complete installation requirements.

IBC Code Reference: "1403.2 Weather protection. Exterior walls shall provide the building with a weather-resistant exterior wall envelope. The exterior wall envelope shall include flashing, as described in Section 1405.3. The exterior wall envelope shall be designed and constructed in such a manner as to prevent the accumulation of water within the wall assembly by providing a water-resistive barrier behind the exterior veneer, as described in Section 1404.2, and a means for draining water that enters the assembly to the exterior. Protection against condensation in the exterior wall assembly shall be provided in accordance with the International Energy Conservation Code.

Exceptions:

1. A weather-resistant exterior wall envelope shall not be required over concrete or masonry walls designed in accordance with Chapters 19 and 21, respectively.
2. Compliance with the requirements for a means of drainage, and the requirements of Sections 1404.2 and 1405.3, shall not be required for an exterior wall envelope that has been demonstrated through testing to resist wind-driven rain, including joints, penetrations and intersections with dissimilar materials, in accordance with ASTM E 331 under the following conditions. . . ."

## STAGING

Heavy building products and components such as roofing, drywall and floor coverings should be stored throughout the structure prior to the installation of the siding. Distributing the weight in this manner will reduce the possibility of floor plate compression on two or more story homes.

## FLASHING

When using James Hardie siding, trim, and weather barrier products, make sure that roof flashing, water table flashing, window and door flashing, and flashing for other building envelope penetrations are properly installed and lapped so that moisture drains down and to the exterior. Note: The successful installation of flashing requires thorough planning before installation of roofing or siding. Scheduling and sequencing are important factors as well as having the correct flashings available on site at the correct time. James Hardie does not recommend the use of mill finished, raw aluminum flashing or any other product that may bleed or adversely react with cement products. Painted or coated aluminum flashings are recommended.

Manufacturers of ACQ and CA preservative-treated wood recommend spacer materials or other physical barriers to prevent direct contact of ACQ or CA preservative-treated wood and aluminum products. Fasteners used to attach HardieTrim Tabs to preservative-treated wood shall be of hot dipped zinc-coated galvanized steel or stainless steel and in accordance to 2009 IRC R317.3 or 2009 IBC 2304.9.5.

IBC Code Reference: "1405.3 Flashing. Flashing shall be installed in such a manner so as to prevent moisture from entering the wall or to redirect it to the exterior. Flashing shall be installed at the perimeters of exterior door and window assemblies, penetrations and terminations of exterior wall assemblies, exterior wall intersections with roofs, chimneys, porches, decks, balconies and similar projections and at built in gutters and similar locations where moisture could enter the wall. Flashing with projecting flanges shall be installed on both sides and the ends of copings, under sills and continuously above projecting trim."



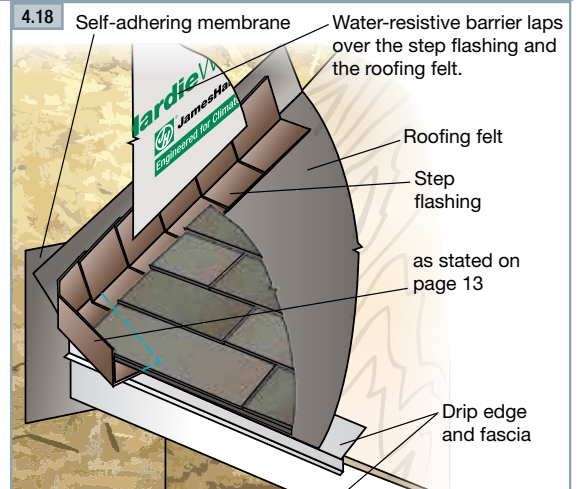
# General Installation Requirements (cont.)

## ROOF-TO-WALL FLASHING

Due to the volume of water that can run down a sloped roof, one of the most critical flashing details is where a roof intersects with a sidewall. Install a self-healing adhesive-backed membrane along the roof/wall intersection before flashing. The membrane on the wall should extend behind the eaves framing and should be installed before the sub-fascia or trim goes on.

The roof should then be flashed to the wall with step flashing positioned at every shingle course. Where the roof begins at its lowest point, install a kickout flashing to deflect water away from the siding. Kickout flashing can be made by cutting and bending a piece of step flashing at an angle. The water-resistive barrier on the wall should then lap over the step flashing.

There are several companies that sell pre-made kickout flashings that are designed to divert water away from the wall. Below is an example of a preformed polypropylene kickout. Be sure to follow all manufacturer's installation instructions.



Copyright © 2009 DryFlekt. All rights reserved.

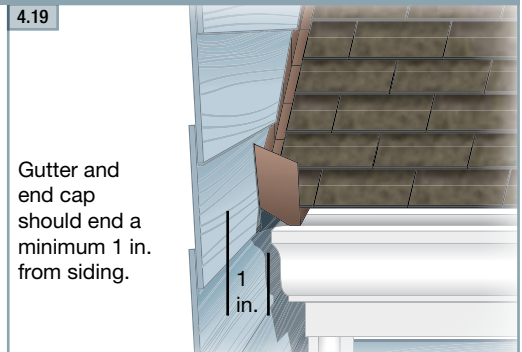
## **WARNING**

**Caution: The kickout flashing shall be min 4 in x 4 in as required by IRC code R905.2.8.3 and be angled between 100° - 110° to deflect water from dumping behind the siding and the end of the roof intersection**

## GUTTERS

If gutters are installed, they should not terminate against siding or trim. Maintain a 1 in. clearance between the siding and the gutter end-cap. Kickout flashings should be installed on the roof above to divert roof runoff into the gutters and away from the 1 in. gap.

The amount of water that can be generated from a rain shower or storm can be substantial. Managing the collection and distribution of this water is important over the life of a home.



**Code Reference: "1503.2.1 Locations. Flashing shall be installed at wall and roof intersections, at gutters, wherever there is a change in roof slope or direction and around roof openings..."**

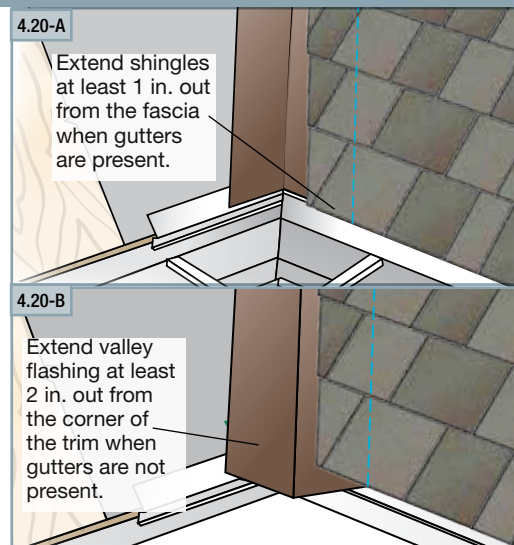
**TIP: James Hardie recommends the use of rain gutters whenever possible.**

## VALLEY FLASHING

For added protection at roof valleys, James Hardie requires one of the following options:

1. If rain gutters are present: As the roof is being shingled, have the roofer extend the shingles at least 1 in. out from the fascia to direct water directly into the gutters (figure 4.20-A).
2. If rain gutters not present: When rain gutters are not present, have the roofer extend the valley flashing at least 2 in. out from the corner to direct water further away from the building (figure 4.20-B).
3. If the roof is already flashed and shingled, add a short piece of flashing to extend the valley in compliance with figure 4.20-B.

The above requirement also applies to roof valley's at any other locations where the fascia runs into a roof line such as dormer valleys and roof-to-roof intersections.

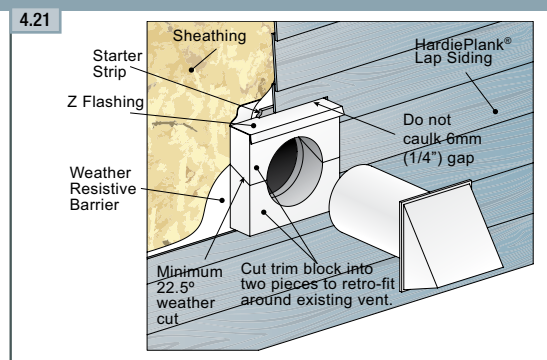


## PENETRATIONS *Recommended in HZ10*

For penetrations in the building envelope such as hose bibs and holes 1½ in diameter or larger, such as dryer vents, a block of HardieTrim® 5/4, 4/4 boards shall be installed around the point of penetration. Blocking **should** be a minimum 3 in radius greater than the radius of the penetration. To install a block around an existing vent pipe, it may be necessary to cut the block into two pieces. In this case, weather-cut the trim to fit it into place. Install flashing over the top of the trim block.

Penetrations through a building envelope are made to accommodate needs such as hose bibs, dryer and furnace vents, electrical conduit, etc. It is important to restore the weather-resistant barrier of the home after cutting a hole for the penetration.

There are several pre-made blocking and flashing products available that can simplify the installation of a penetration. One such example is Sturdimount®. Be sure to follow all manufactures installation instructions.



**SturdiMount**

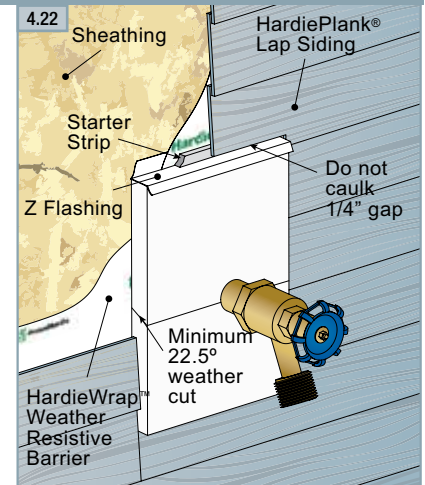
**TIP:** As most penetrations will require blocking and flashing, some planning is required. As the trim is ordered for the home, don't forget to order some extra to serve as blocking.

# General Installation Requirements (cont.)

## HOSE BIBS

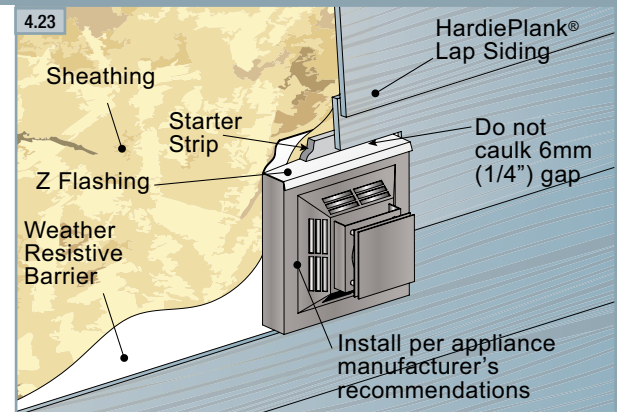
Hose bibs are a source of water which increases the likelihood of moisture related problems. The goal is to keep the water outside of the building and the best way to do this is keep the water off the walls. A good preventative measure is to extend the hose bib further from the wall. A downward slope on the water pipe as it leaves the building will also encourage any slow leaks to fall away from the home.

Large piping over 1½ in. diameter is required to have blocking and flashing at the penetration. A block of HardieTrim® 5/4, 4/4 boards should be installed around the point of penetration. To install a block around an existing pipe, it may be necessary to cut the block into two pieces. In this case, weather-cut the trim to fit it into place. Install flashing over the top of the trim block.



## HOT AIR VENTS (Dryer, Stove, Furnace, Heater, Etc.)

For hot air vents including dryer vents, stove vents, and furnace and heater exhaust, it is important to move the air away from the building envelope. As the vent is installed, a path for that moisture to leave the area should be identified. Consider what is being vented and where it is going before installing the vent. For instance, a dryer vent directly under an eave is going to force hot, moist air to rise and collect at the soffit. A good preventative measure for many vents is to increase the distance they extend from the wall to help expel moisture from the building.



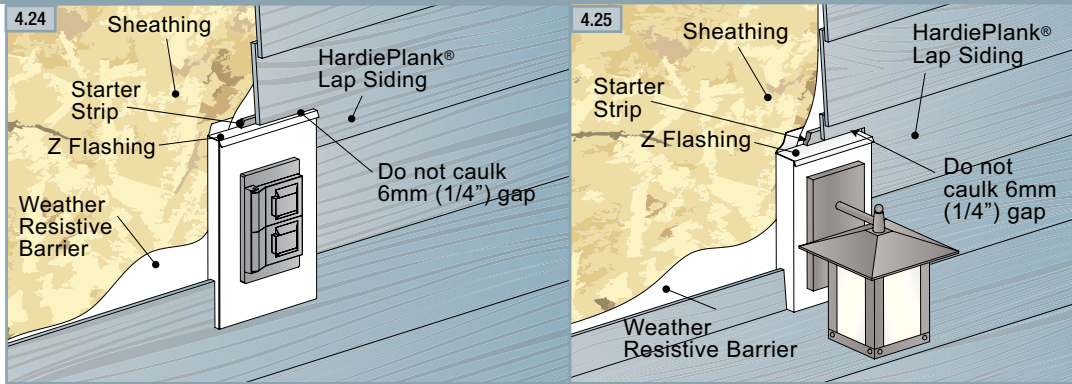
For dryer vents, avoid placement too low to the ground where debris could easily impede air flow, trapping heat and moisture. Some types of high efficiency furnaces can be vented out through the walls. In these cases, avoid locating the vent too close to the roof or eaves where heat and moisture will be trapped.

**TIP: Consider location of the vent prior to installation and consider extending the vent further from the wall.**

Any vent piping is required to have blocking and flashing at the penetration. A block of HardieTrim® 5/4, 4/4 boards should be installed around the point of penetration. The blocking should extend 3-4 in. along the wall from the edge of the vent. To install a block around an existing vent, it may be necessary to cut several blocks, with weather-cuts on each piece. Flashing must be installed over the top of the trim block.

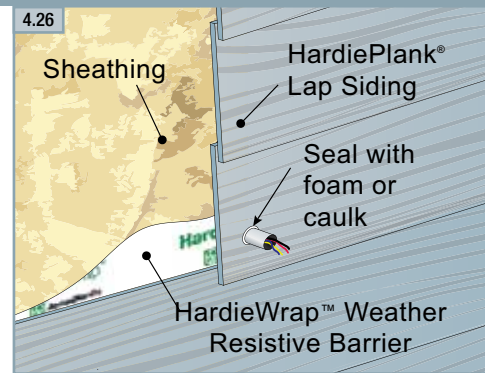
## LIGHTS AND ELECTRICAL OUTLETS

Lights and Electrical boxes should have the same flashing and blocking as other large penetrations such as vents. Many lights utilize square electrical boxes. Blocking a square object should still incorporate the best practices of an angled weather cut.



## WIRES, CONDUIT OR OTHER FIXED PIPES

For small penetrations such as wires, electrical conduit, and pipes less than 1½ in. in diameter (excluding hose bibs) no blocking is necessary. The circumference of pipe or wire should be sealed with a barrier foam and/or caulked.

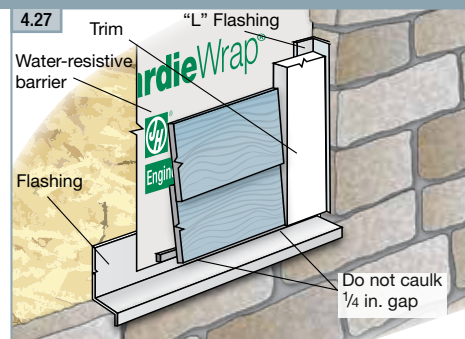


## AIR CONDITIONERS, SERVICE PANELS, AND OTHER WALL MOUNTED DEVICES

Wall mounted devices and air conditioners represent large penetrations into the building envelope and structure. Before installing a unit, please consult the architect or structural engineer to determine if additional bracing is necessary. The device should be installed per manufactures instructions and flashed properly. Any condensate drains should extend out 4 in from the wall, and angle down.

## BUTTING TO MORTAR OR MASONRY

James Hardie® siding and trim products should not be butted directly against mortar or masonry, including stone, brick, or concrete block. In these situations, a flashing should be installed to isolate the trim or siding from the mortar or masonry.



## CLEARANCES

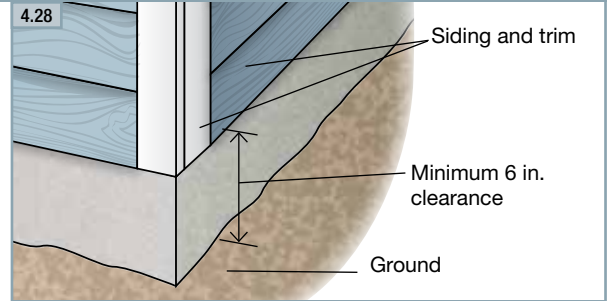
James Hardie specifies clearances to ensure the long-term durability of their products and the buildings on which they are installed. Failure to provide the proper clearances, as specified below, may affect performance of the building system, violate building codes or James Hardie requirements, and may void any warranty on the products.



# General Installation Requirements (cont.)

## SIDING TO GROUND CLEARANCE

James Hardie products must be installed with a minimum of 6 in. clearance to the ground on the exterior of the building. Clearances greater than 6 in. may be required in accordance with local building codes. Foundations are typically required to extend above the adjacent finished grade a minimum of 6 in. or as required by local building codes.

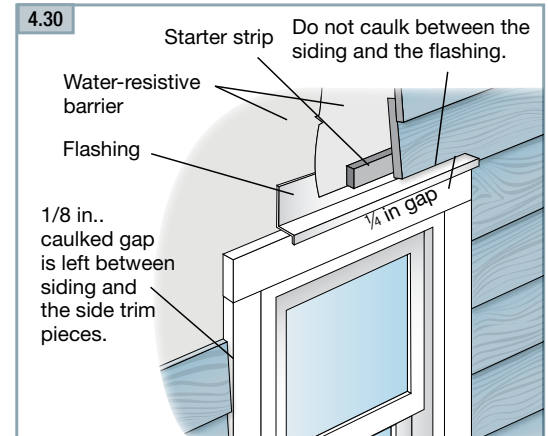
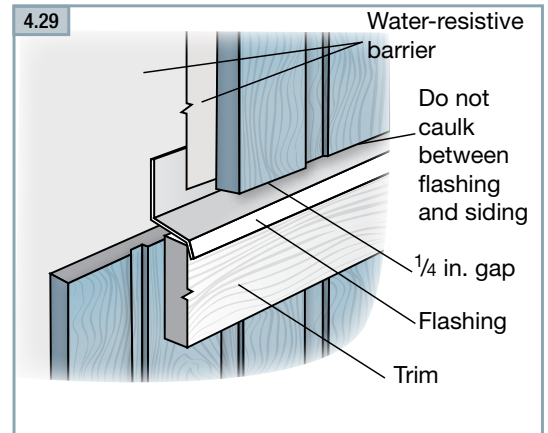


**IBC Code Reference:** "1803.3 Site grading. The ground immediately adjacent to the foundation shall be sloped away from the building at a slope of not less than one unit vertical in 20 units horizontal (5-percent slope) for a minimum distance of 10 feet (3048 mm) measured perpendicular to the face of the wall..."

## SIDING TO FLASHING CLEARANCE

A 1/4 in. clearance must be maintained between James Hardie® siding and trim products and any horizontal flashing.

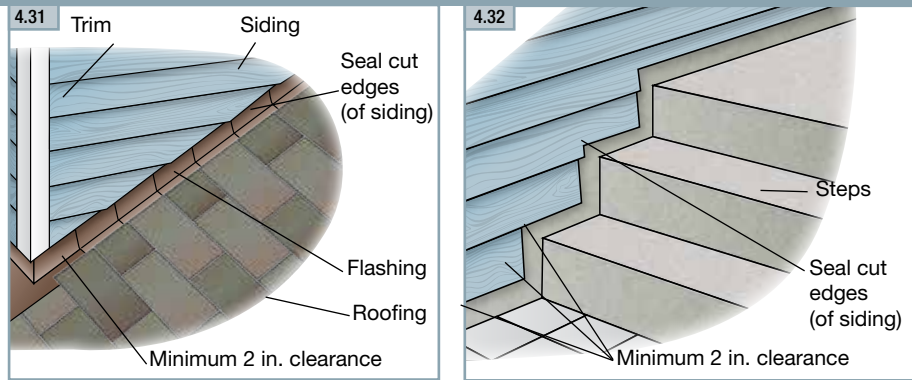
All horizontal flashing should be installed with a positive slope in such a way that it promotes proper drainage and does not allow moisture to pool on top of the flashing.





## SIDING AND TRIM TO SOLID SURFACES

A clearance of 2 in. must be maintained between James Hardie siding and trim products where they meet roofs, decks, paths, steps, driveways or any other solid surfaces.



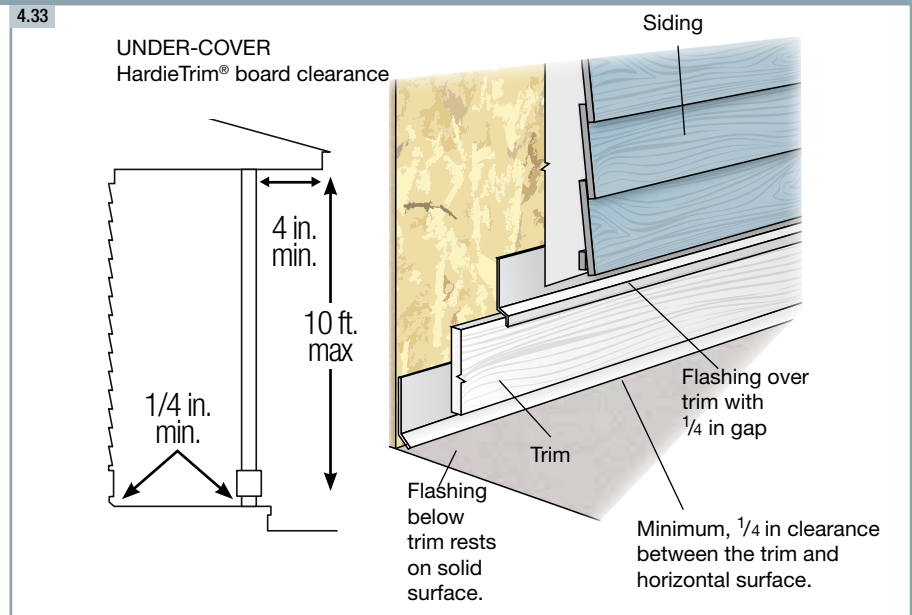
Code Reference: "1503.2.1 Locations. Flashing shall be installed at wall and roof intersections, at gutters, wherever there is a change in roof slope or direction and around roof openings..."

IRC Code Reference: "905.2.8.3 Sidewall flashing. Base flashing shall be continuous or step flashing shall be a minimum of 4 in. in height and 4 in. in width"

## CLEARANCES FOR SHELTERED AREAS

Maintain a 1/4 in. clearance for HardieTrim boards installed under cover. Under cover is defined as:

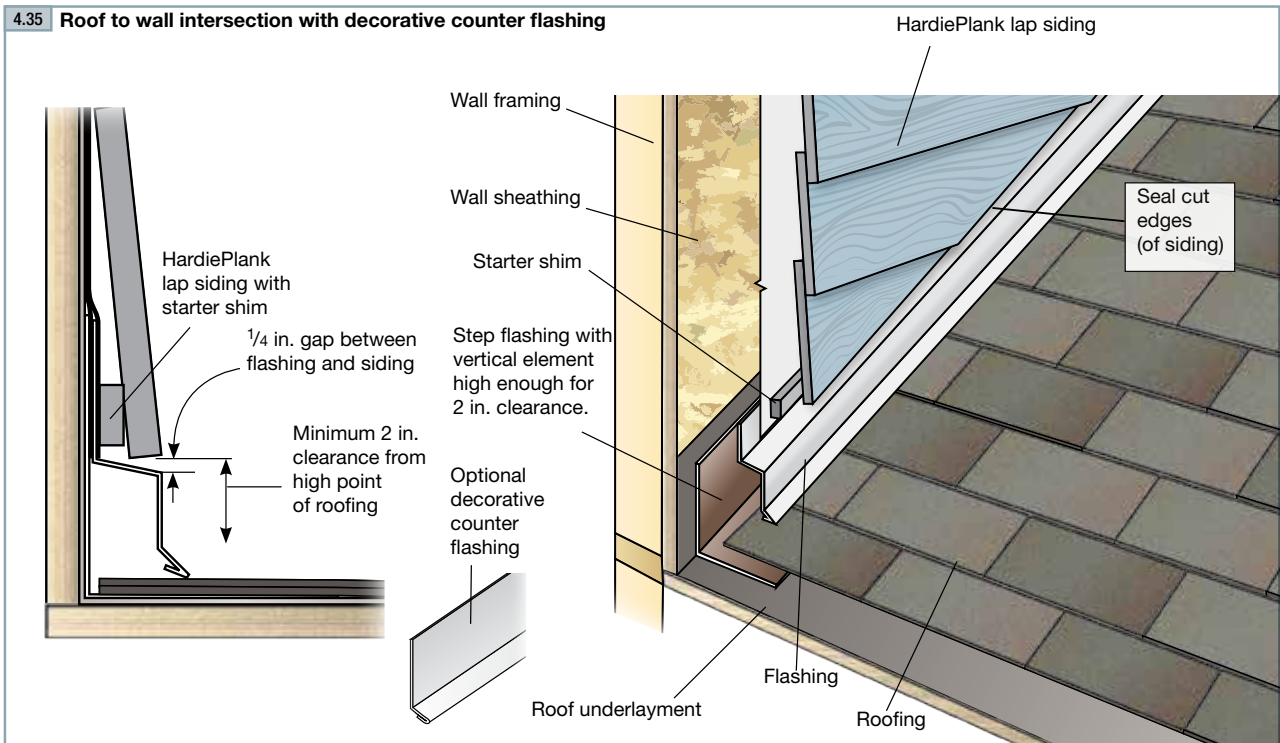
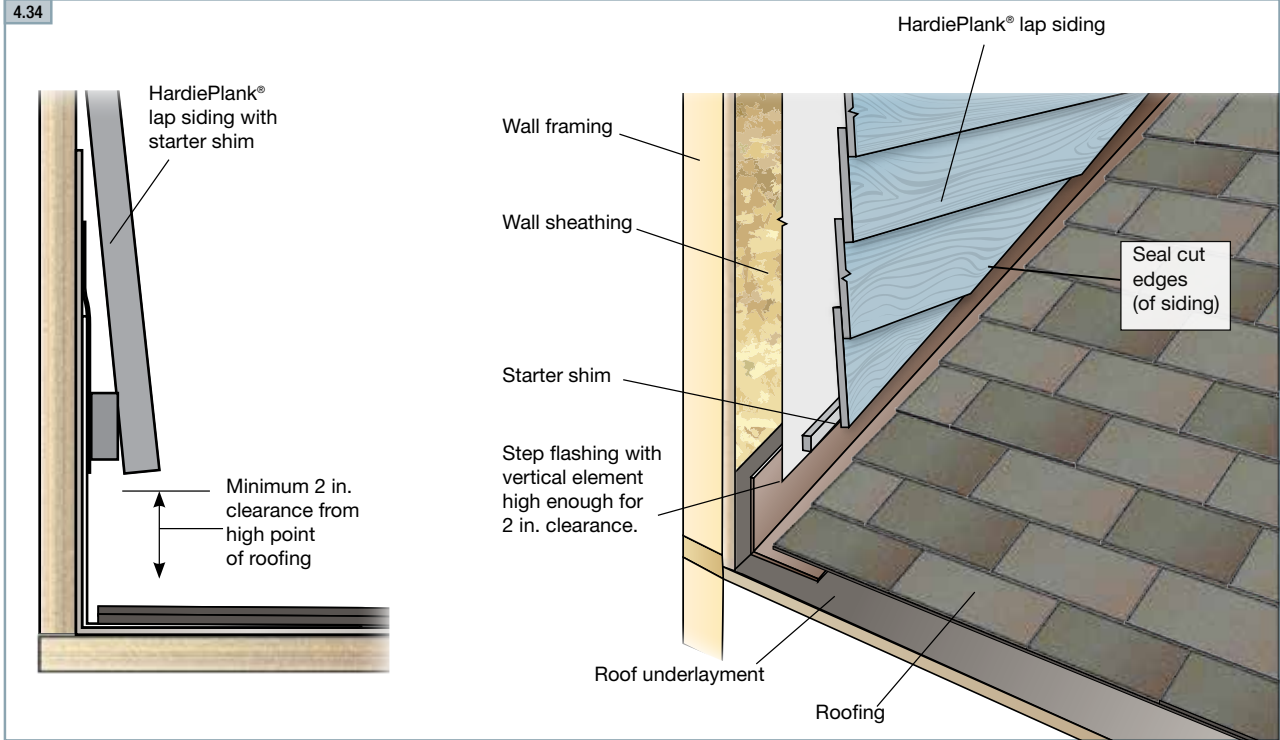
- Not more than 10 feet below a roof overhang, and
- Not less than 4 inches horizontally from the edge of the roof overhang



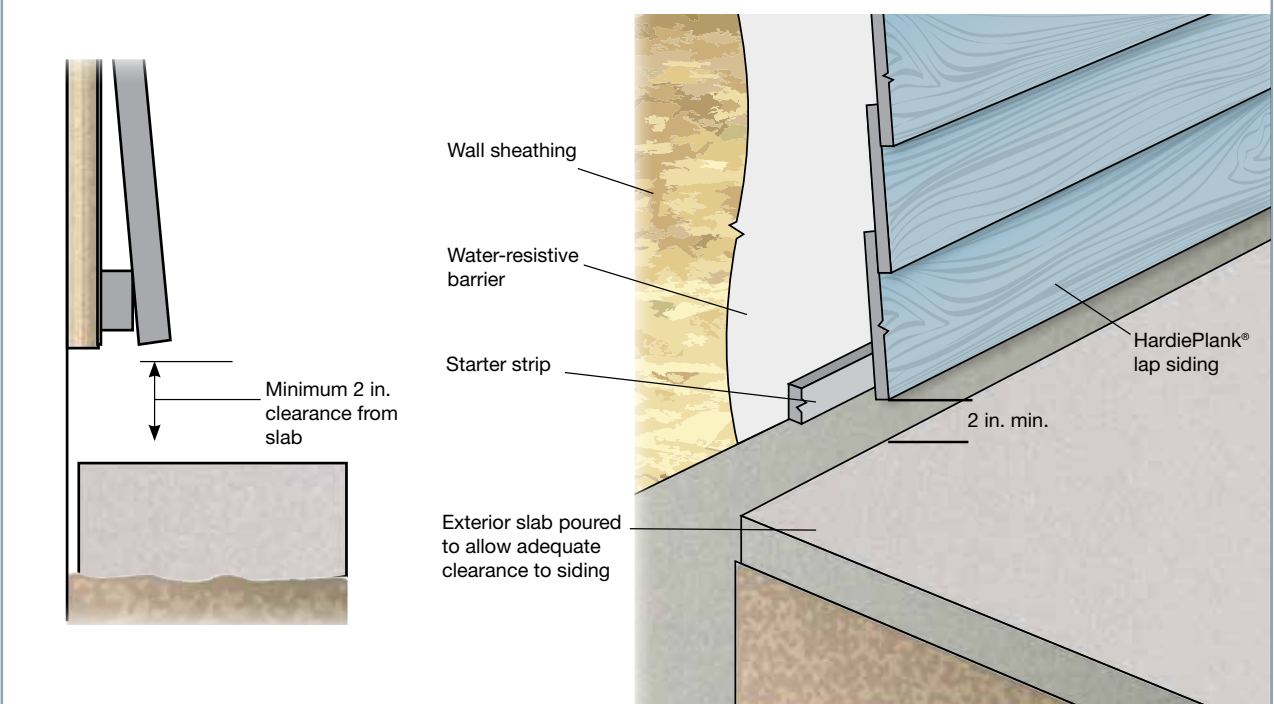
**WARNING**  
 James Hardie siding and trim products must not be installed such that they remain in contact with standing water.

# General Installation Requirements (cont.)

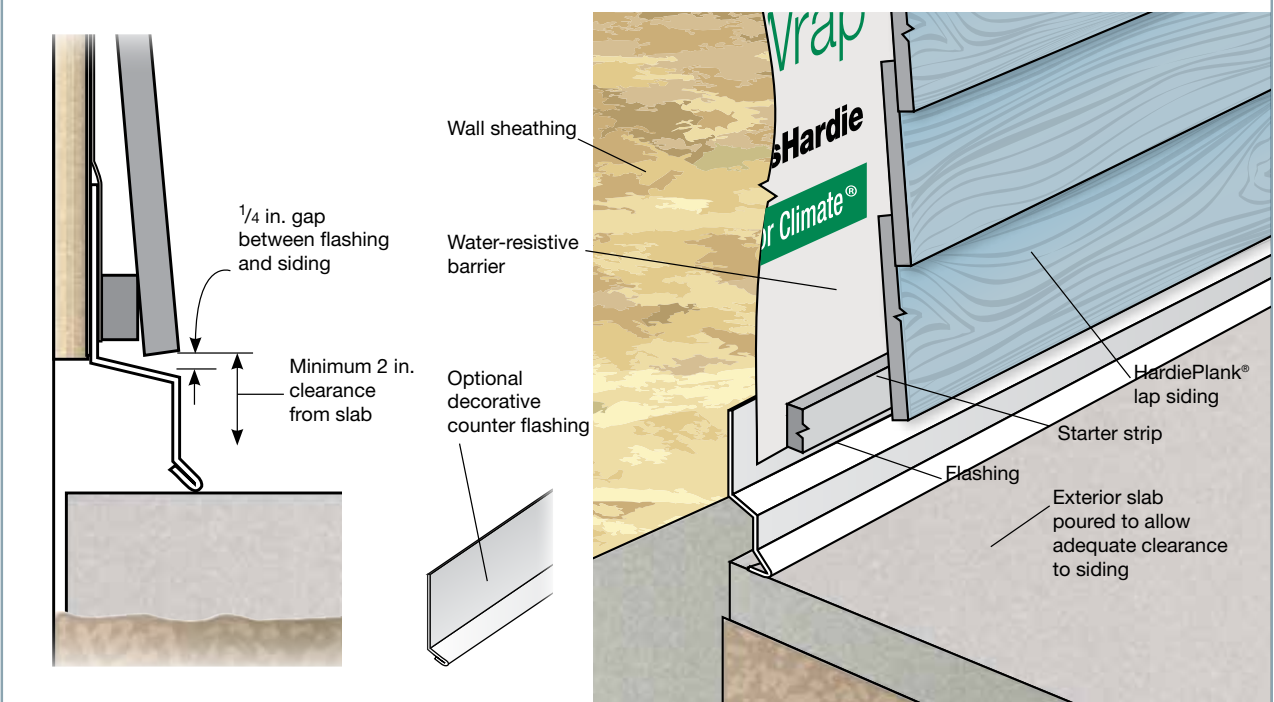
Here are examples of details that can help improve the aesthetics of clearance requirements. Check with a design professional and local building officials to ensure that the chosen details are correct for their intended purpose and location.



4.36 Wall to exterior slab intersection without decorative counter flashing

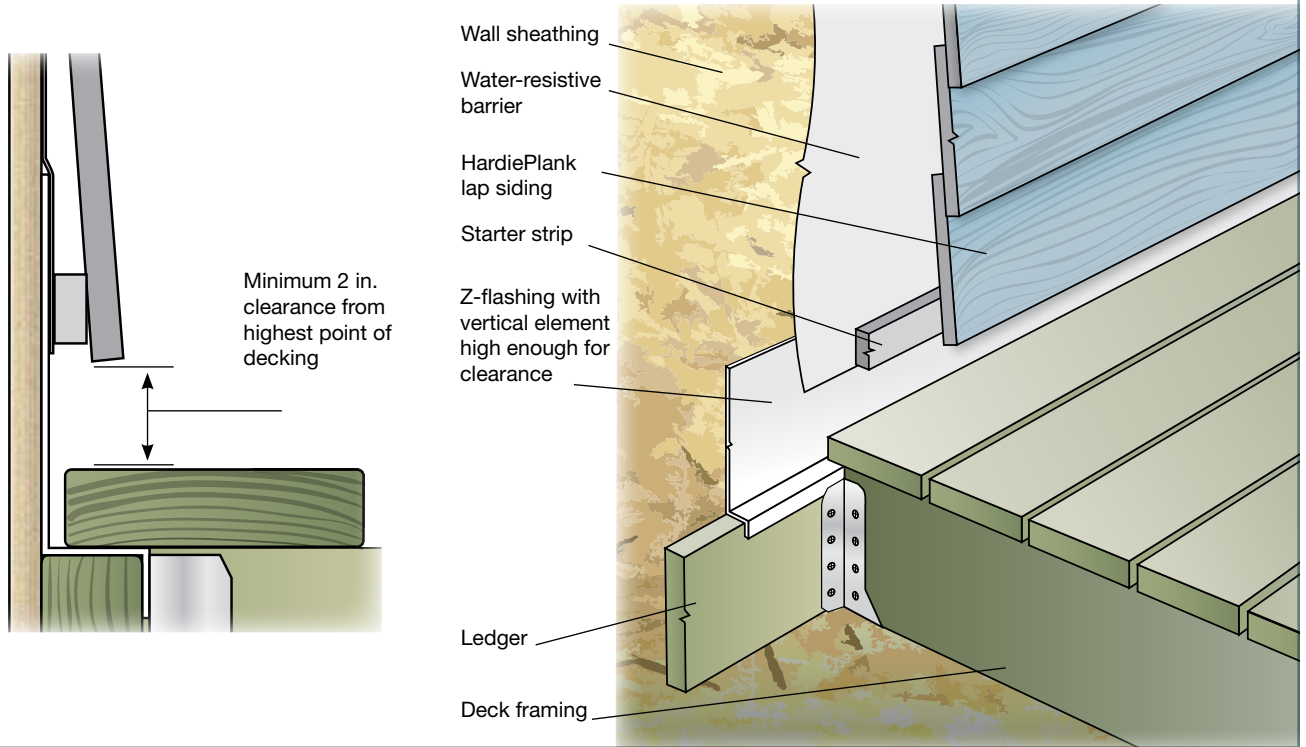


4.37 Wall to exterior slab intersection with decorative counter flashing

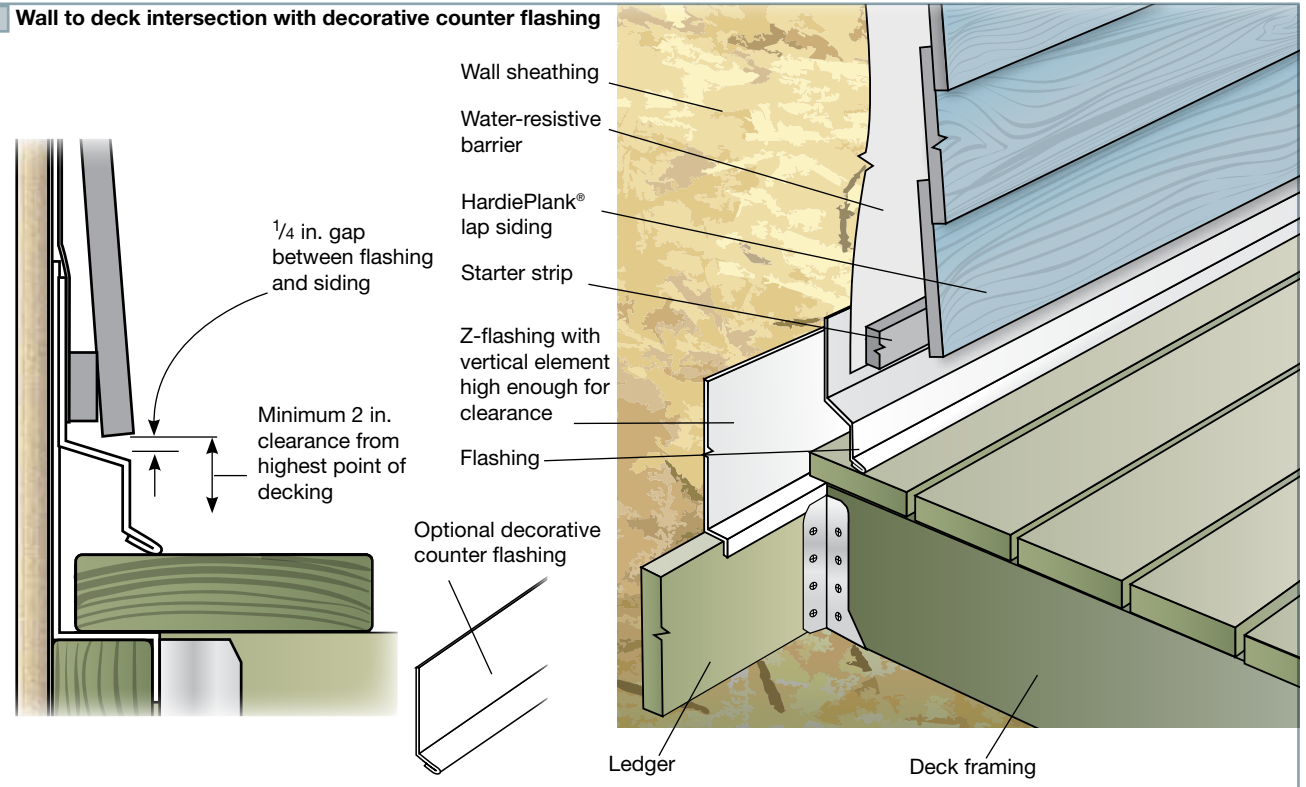


# General Installation Requirements (cont.)

**4.38 Wall to deck intersection without decorative counter flashing**



**4.39 Wall to deck intersection with decorative counter flashing**





# General Fastener Requirements

Each product section of the James Hardie Installation Guide contains fastener requirements for that specific product. In general if siding is to be installed over a non-structural sheathing such as foam, gypsum, or builder board, increase the length of the fastener by the thickness of the non-structural sheathing. For example, if a 1 ¼ in. fastener would normally be required for an application, but the siding is being installed over ½ in. foam sheathing, increase the fastener length by ½ - ¾ in. fastener length. For siding installation over a framed wall with structural sheathing such as plywood or OSB, the fastener length does not need to be increased.

<p><b>5.1 Stud wall without sheathing</b></p>	<p><b>5.2 Stud wall with APA rated wood sheathing</b></p>	<p><b>5.3 Stud wall with foam sheathing</b></p>
---	---	---

## WARNING

When installing siding over foam sheathing, care must be taken not to overdrive the nails and compress the foam. The resulting unevenness in the wall could distort the siding and give the wall an unsightly wavy appearance.

## PNEUMATIC FASTENING

James Hardie® siding and trim products can be hand-nailed or fastened pneumatically. However, fastening with a pneumatic nailer is recommended for speed and consistency. Nails should be driven snug or flush with the surface of the siding.

For pneumatic nailing, set the air pressure so that the nails are driven to the proper depth. A flush mount attachment on the head of the nailer is recommended. If setting the nail depth proves difficult, choose a setting that slightly under-drives the nails. Then drive any under-driven nails snug to the surface with a smooth-faced hammer.

If nails are driven too deep, countersink them with a nail set, and fill, then drive another nail near by to the proper depth. Never use staples to attach James Hardie products.

**TIP: Stainless steel fasteners are recommended when installing James Hardie products.**

**5.4**



# Finishing

## FINISHING JAMES HARDIE® SIDING AND TRIM PRODUCTS

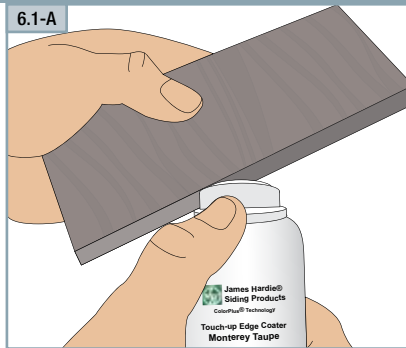
For best results when painting factory-primed James Hardie® siding and trim products, use high-quality exterior-grade acrylic topcoats. For best results with unprimed James Hardie siding and trim products, prime first with exterior-grade acrylic primer, and then finish with high-quality exterior-grade acrylic topcoats. Two finish coats of paint are recommended.

Use primers and topcoats that are designed and recommended for cement-based building materials such as fiber-cement, masonry, brick or stucco.

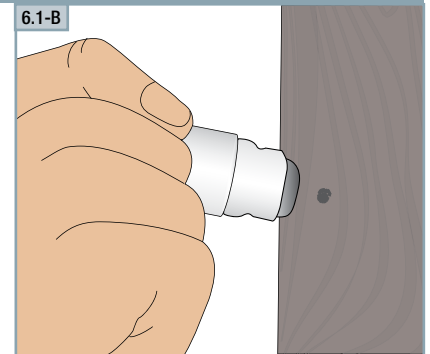
### WARNING

- Finish factory primed James Hardie siding and trim products within 180 days of installation.
- The use of oil-based paints on unprimed fiber cement could result in increased surface roughness, loss of adhesion, cracking or excessive chalking.
- DO NOT use stain, oil/alkyd base paint, or powder coating on James Hardie® Products.
- Never apply paint to saturated product.

## COLORPLUS® TOUCH-UP



**Edge Coater** - edge coating is required for any field cuts to seal the edges and make joints less visible.



**Touch-up Pens** - conceal nailheads and very small nicks and scratches less than a dime size. Replace the area with a new piece of plank or panel if area is larger than a dime.

**Note:** Edge Coaters or Touch-up Pens should not be used to touch-up any area that is larger than a dime.

**Note:** James Hardie [JH] does not approve caulk (including JH Color matched caulk), other caulking or cementitious patching compounds to touch up nail heads, nail holes, dents, cracks or other minor surface blemishes on JH ColorPlus products.

### WARNING

Do not allow ColorPlus touch-up to freeze. Apply touch-up when temperature of the air and the siding products is above 40°F (4°C).

## COLORPLUS® PRODUCTS WITH PROTECTIVE LAMINATE SHEET

When installing HardieTrim® 5/4, 4/4 boards with ColorPlus® Technology, leave the protective laminate sheet on the board during cutting and installation. To install HardieTrim 5/4, 4/4 boards with ColorPlus® Technology, first fasten the trim using a finish nailer with the nails driven through the laminate sheet. Using a touch-up pen that matches the color of the trim, cover up the nail heads through the laminate sheet at the point of entry. After the nailing and touch-up are complete, remove the protective laminate sheet.



When installing other products such as HardiePlank® Lap Siding and HardiePanel® Vertical Siding with ColorPlus® Technology, leave the protective laminate sheet on the board during cutting and installation. Once the product is installed the laminate sheet should be removed.

**TIP: As with any pre-finished building product, care should be taken when handling and cutting James Hardie ColorPlus products. At the job-site use a soft cloth to gently wipe any residue or construction dust left on the product**

## CAULK

James Hardie recommends the use of caulks and sealants that remain permanently flexible. Look for the words “permanently flexible” written clearly on the label or in the accompanying literature.

For best results, use an Elastomeric Joint Sealant complying with ASTM C920 Grade NS, Class 25 or higher, or a Latex Joint Sealant complying with ASTM C834. Caulking/sealant must be applied in accordance with the caulking/sealant manufacturer’s written instructions.

James Hardie does not warrant and does not accept liability for the appearance or the performance of field-applied caulks and sealants.

## REPAIR PATCHING

Dent, chips, cracks and other minor surface damage in James Hardie primed siding and trim products can be filled with cementitious patching compound except on ColorPlus. When repairing holes of less than 1 in. that has been created by scaffold anchors, pipe, etc. James Hardie recommends a backer rod be placed into hole and sealed to prevent water infiltration. James Hardie will assume no responsibility for water infiltration.

## BACK PRIMING/BACK SEALING

James Hardie does not require any of its siding products to be back sealed or back primed prior to installation in the field.

## MAINTENANCE

This maintenance instruction applies to all James Hardie® products, including PrimePlus® and ColorPlus® Technology.

Always follow the instructions and precautions outlined in the James Hardie® ColorPlus® Technology literature that was supplied with the product and the information that is available on the James Hardie® website ([www.jameshardie.com](http://www.jameshardie.com)), including James Hardie ColorPlus Technology instructions and precautions

The extent and nature of the maintenance required will depend on the geographical location, the exposure of the building and whether your product is prime or ColorPlus product. Cleaning, as needed, is recommended to remove dirt, dust, chalking, oil, grease, organic contaminants, or mold that may build up on the product surface over time. Dust from cutting and construction dust should be removed IMMEDIATELY upon installation (refer to the cleaning instruction in the table below). During cleaning, always wear appropriate protection (gloves and eyewear) and shield any landscaping or vegetation.

Surface cleaning recommendation is given below for specific product conditions. (Please note that damage to siding arising from improper cleaning or maintenance may not be covered by the James Hardie warranty).

Recommendation	Construction/Cutting/ Existing Dirt and Chalk	Oil, grease or other organic contaminants	Mold and Mildew
Tools	Soft cloth, soft All Paint poly brush or chip brush or horsehair bench brush, garden hose. (Do not use hard brush (for example, scrub brush or an abrasive scrub sponge) that could damage the finish or siding.	Soft cloth and garden hose	Soft cloth or soft sponge and garden hose
Solution	Water	Mild liquid dishwashing soap (Dawn®, Ivory®, or Joy®) and water. (Do not use any harsh cleaning chemicals)	Mildew cleaners (Jomax®, Mildew Check®, Mold Armor®) and water
Method	<ol style="list-style-type: none"> <li>1. If using a brush, brush the product surface dust, dirt or chalk, then rinse the area with a garden hose.</li> <li>2. If using a soft cloth, wet the cloth then wipe the area until clean and rinse the area with clean water. Rinse the cloth frequently.</li> </ol>	<ol style="list-style-type: none"> <li>1. Use soft cloth wetted with soapy water to clean the area. Rinse the cloth frequently.</li> <li>2. Use a garden hose to rinse the area.</li> </ol>	<ol style="list-style-type: none"> <li>1. Follow the mildew cleaner instruction.</li> <li>2. Lightly scrub the area with mildew.</li> <li>3. Use garden hose to rinse the area.</li> </ol>

Soft All Paint Brush



Horsehair Brush



Chip Brush



Siding Brush



It is always suggested to work a small section at a time, start from the top and work your way down to prevent dripping or streaking onto the cleaned area.

Gently clean the siding with the soft brush or wet soft cloth in a side to side motion in the direction of the plank siding. If cleaning panel, direction of the siding is up and down. Do not push soft brush or wet cloth too hard against product surface. Do not allow the soap and mildew cleaner to dry on the siding (continually rinse the area until all of the cleaner has washed off of the siding). Any areas that have been missed may show up when the siding has dried. Spot clean and rinse any missed areas as needed.

If your surface still looks dirty after washing methods for dust/dirt and oil/grease, the problem may be mildew. Mildew discoloration can resemble dirt. Moisture is the most important single factor in the growth of mildew, which can lie dormant for years. For this reason, mildew discoloration is usually found in damp, dark areas or during prolonged humid conditions. Follow all instructions and precautions that are outlined on the label of the mildew cleaners and wear all protective equipment that is prescribed.

At all times, care must be taken not to use harsh or harmful chemicals that can damage the finish on the siding.

**WARNING**

High pressure water blast and sand blasting may damage the surface of the fiber cement product. Low pressure water spray, a soft medium bristle (nonmetal) brush is most suitable for cleaning fiber cement products. Acid washing can damage the fiber cement surface and is not recommended.

Note: If using a pressure washer, care must be taken to ensure that the water stream does not damage the surface of the siding. Damage to siding arising from improper cleaning or maintenance may not be covered by the James Hardie warranty. Using wide fan tips that are kept a minimum of 6 feet from the wall and at pressures under 1500 psi will minimize the chance of damaging the siding.

## HardieWrap® Products Description

### HARDIEWRAP® WEATHER BARRIER

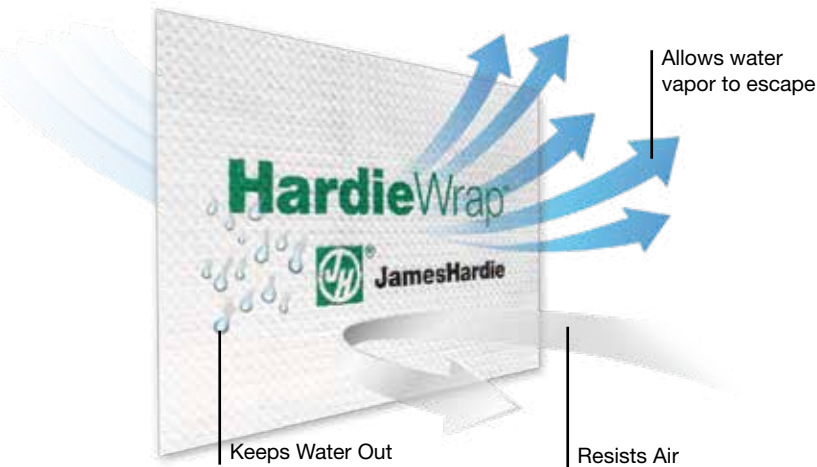
HardieWrap weather barrier is a non-woven, non-perforated polyolefin water-resistive barrier, as per AC38. HardieWrap weather barrier provides a balance of water resistance and breathability to protect homes from the elements of weather that can get behind the exterior cladding. HardieWrap Flashing and HardieWrap Seam Tape are recommended in conjunction with HardieWrap weather barrier to complete the HardieWrap weather barrier solution.

### HARDIEWRAP® PRO-FLASHING AND FLEX FLASHING

HardieWrap® Pro-Flashing and HardieWrap® Flex Flashing are high-performance, self-adhering, self-sealing, butyl material on tear-resistant top sheets that are applied around windows and doors to manage water and air intrusion. HardieWrap® Pro-Flashing has a release liner for peel-and-stick installation and has no asphalt, VOCs or solvents.

HardieWrap® Flex Flashing is designed to easily stretch and seal around doors and windows, as well as custom shapes to protect against water intrusion, and is supplied in a convenient dispenser box.

Together with HardieWrap® weather barrier and HardieWrap® Seam Tape, HardieWrap® Pro-Flashing and HardieWrap® Flex Flashing provide the James Hardie® weather barrier solution to manage water drainage, and prevent water damage and energy loss.



HardieWrap® Weather Barrier



HardieWrap® Pro-Flashing



HardieWrap® Flex Flashing



HardieWrap® Seam Tape

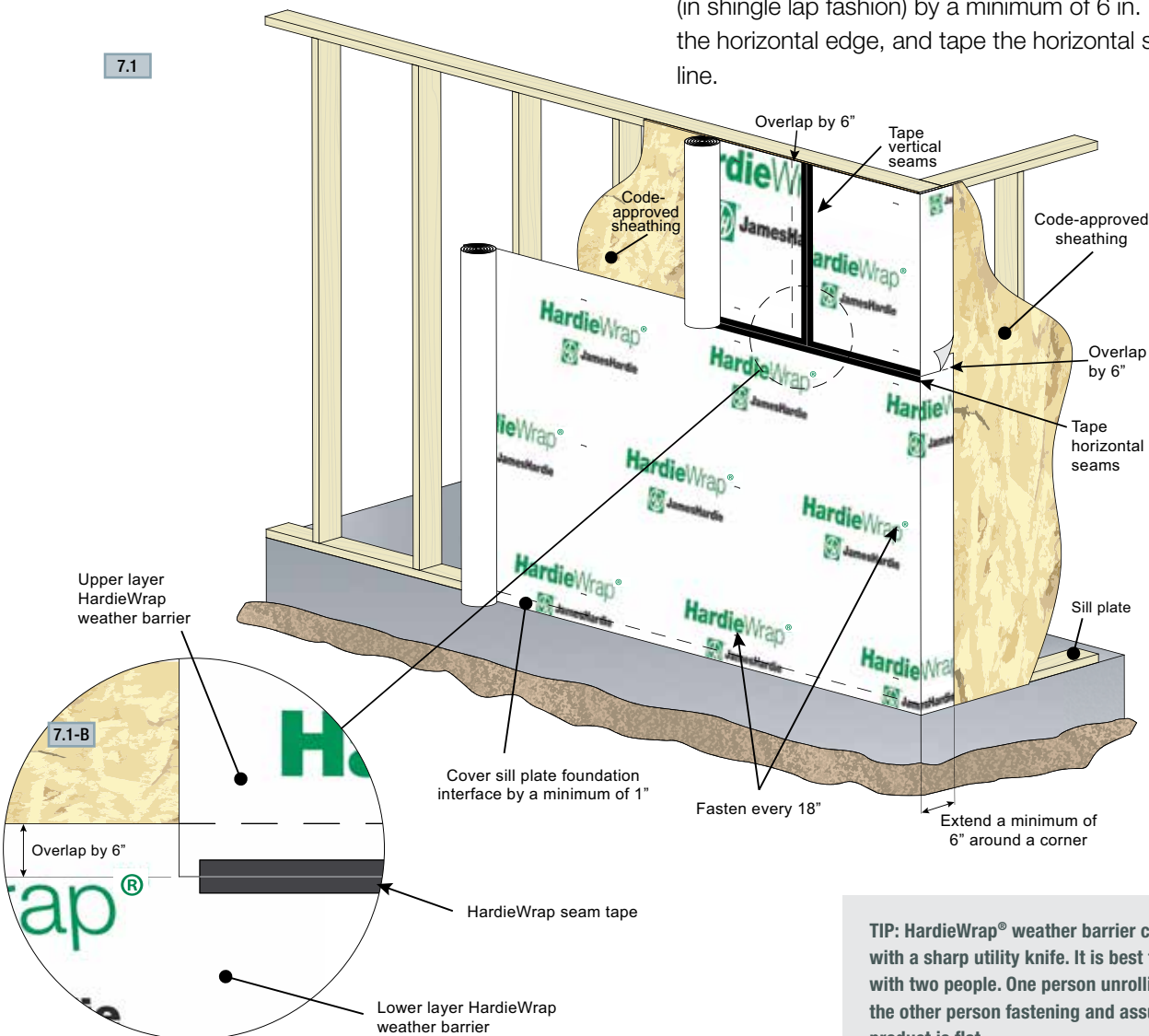


# Installation of HardieWrap® Weather Barrier

## INSTALLATION OF HARDIE WRAPS

HardieWrap weather barrier should be installed before window and door installation. Do not install on saturated sheathing. HardieWrap weather barrier can become slippery and should not be used in any application where it may be walked on.

1. Begin by affixing the weather barrier, at least 6 in. around a building corner (fig. 1). Unroll horizontally (with print side facing out) around the building, covering rough window and door openings.
2. Fasten to studs or nailable sheathing material with galvanized construction grade staples a maximum of 18 in. in the vertical and horizontal directions. (Tip: HardieWrap is fastened by staples or roofing nails only)
3. Attach weather barrier so that it is taut and flat. The vertical overlap must have a minimum of 6 in. and the vertical seam must be taped.
4. HardieWrap Seam Tape is strongly recommended, but do not clog or interfere with the use of weep holes or similar drainage details.
5. Ensure that the bottom edge of the weather barrier extends over the sill plate and foundation interface by at least 1 in. Overlap upper layers of weather barrier (in shingle lap fashion) by a minimum of 6 in. below the horizontal edge, and tape the horizontal seam line.



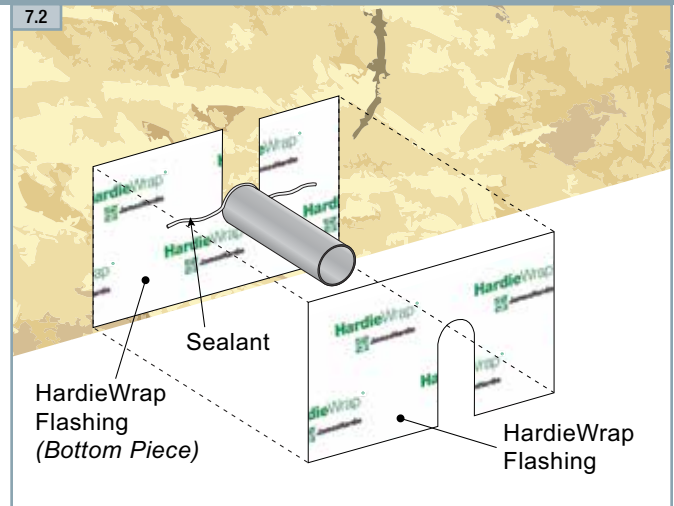
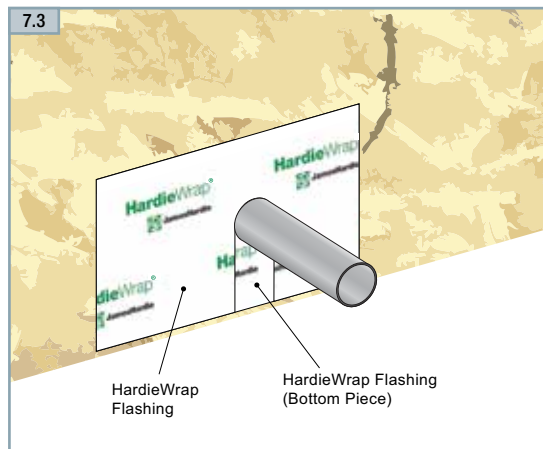
**TIP:** HardieWrap® weather barrier cuts best with a sharp utility knife. It is best to install with two people. One person unrolling, and the other person fastening and assuring product is flat.

# Installation of HardieWrap® Pro-Flashing & Flex Flashing

## HARDIEWRAP® FLASHING GUIDE FOR TYPICAL PENETRATION

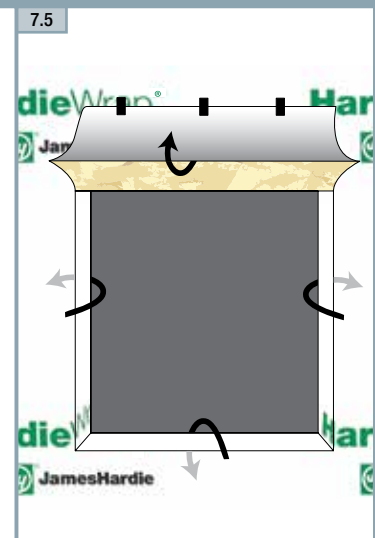
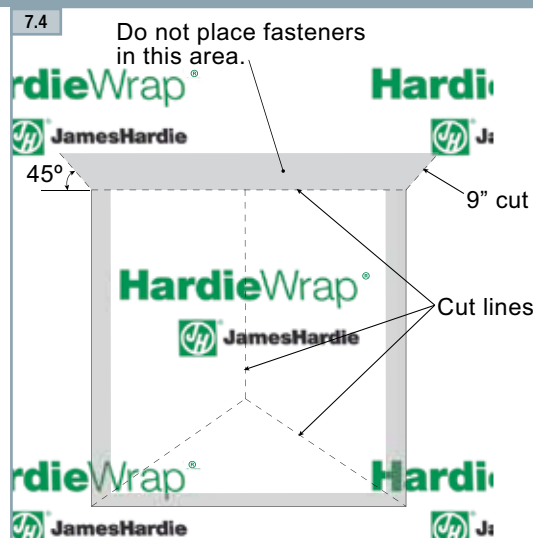
For rough electrical or plumbing penetrations, seal with flashing. Install the top piece over the bottom piece. HardieWrap® Pro-Flashing can be used for this application.

Make sure all penetrations are taped to shed water and prevent air infiltration.



## HARDIEWRAP® PRO-FLASHING GUIDE FOR WINDOWS

Use the inverted “Y” cut at rough window and door openings. Do not place fasteners within 9 in of the rough opening, door or window heads. This area should not be fastened to allow for proper flashing installation. At the top corners of the rough opening, cut the weather barrier at 45° to extend 9 in past the joint. Fold the top flap up and out of the way and fasten temporarily and fold the remaining three flaps in through the opening, fastening them inside with staples.



HardieWrap® Flex Flashing should be applied over the water-resistive barrier after it has been cut and set into and around the window rough opening. Refer to installation of HardieWrap® Pro-Flashing and Flex Flashing for flashing guidelines.

## STORAGE

For optimal performance, store in original sealed packaging at temperatures of 5° - 32°C (41° - 90°F) while at moisture-free conditions. James Hardie requires that HardieWrap® Flashing and HardieWrap® Flex Flashing be covered within 180 days of installation.

## IMPORTANT TO NOTE

This recommendation refers to the most commonly used types of windows (surface-mounted). For other types of frames, special attention should be paid to the window manufacturer's instructions.

Check your local building code for construction requirements and follow the manufacturer's recommended installation instructions; or utilize standard practices for the installation of exterior windows and doors as referenced in ASTM E2112-01 or AAMA 2400-2 (CAWM 400-95). Consult with the architect or specifier regarding the methods to be utilized.

## GENERAL REQUIREMENT

The installation guidelines herein are informational in nature only and may not be appropriate for use in all applications. It is the sole responsibility of the architect or specifier to identify moisture-related risks associated with any particular building design, and to make any appropriate adjustments or modifications to the installation guidelines herein. Wall-construction design must effectively manage moisture, considering both the interior and exterior environment of the building, particularly in buildings that have a higher risk of wind-driven rain penetration and conditioned spaces. Wall openings, penetrations, junctions, connections, window sills, headers and jambs must incorporate appropriately installed HardieWrap® Pro-Flashing and HardieWrap® Flex Flashing, or other flashing or flashing details, as recommended by the manufacturer, architect or specifier.



HardieWrap® Pro-Flashing



HardieWrap® Flex Flashing



HardieWrap® Seam Tape

# Installation of HardieWrap® Pro-Flashing & Flex Flashing (cont.)

## HARDIEWRAP® FLEX FLASHING STRETCHABLE SILL FLASHING

Prepare sill flashing by cutting HardieWrap® Flex Flashing at least 12 in. longer than the width of the rough opening. Install sill flashing by removing the release paper, centering sill flashing on sill framing stud and adhering into rough opening. The back edge of HardieWrap® Flex Flashing should extend to the inside edge of the sill framing stud and at least 6 in up each jamb framing stud. (Note: Sill flashing should not wrap onto the inside of the wall.) **DO NOT STRETCH MATERIAL ALONG THE SILL OF JAMB.** HardieWrap® Flex Flashing should be applied over the water-resistive barrier after it has been cut and set into and around the window rough opening.



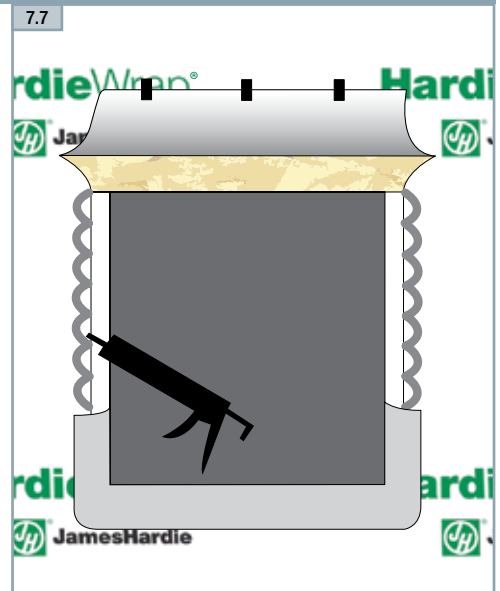
*Note: If a water-resistive barrier is to be applied after the window and flashing have already been installed, be sure not to fasten the lower edge of the flashing so that the water-resistive barrier may be slipped underneath the flashing in weather-board or shingle-lap (top layer overlapping bottom layer) fashion.*

## WINDOW INSTALLATION

Before installing the window:

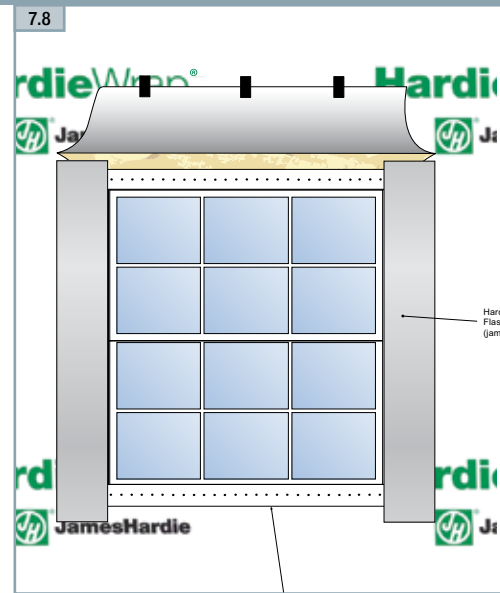
- Apply a continuous bead of sealant to the backside (interior) of the window's mounting flange on the outer edge; or
- Apply a continuous seal to the rough opening to ensure contact with the backside (interior) of the window's mounting flange (do not caulk along bottom).

Install window according to the manufacturer's installation procedures.



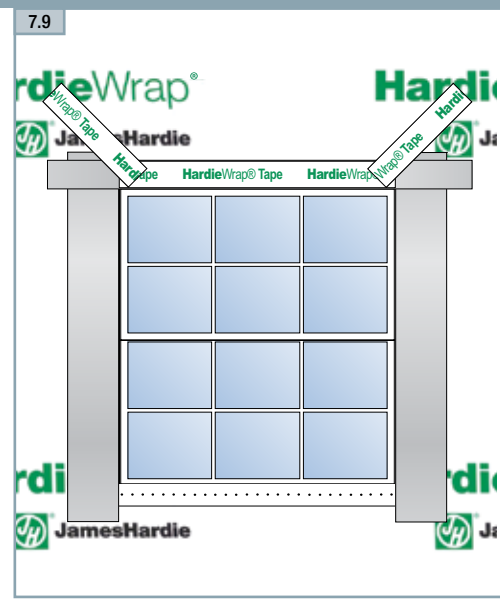
## SIDE JAMB FLASHING

Apply HardieWrap® Flashing along the vertical sides of the opening. Flash over the side window mounting flanges. Extend the flashing by a minimum of 3 in. beyond the sill flashing (HardieWrap® Flex Flashing) already in place and extend the flashing to a minimum of 3 in. beyond the top of the opening, so that it projects beyond the head flashing that is to be applied later.



## HEAD FLASHING

Affix HardieWrap® Flashing over the window's mounting flange along the header opening. Be sure to extend the flashing beyond each jamb flashing by 3 in. Secure flashing in place by applying pressure. Detach weather barrier flap (top) and apply over head flashing as shown. Tape all seams and joints.



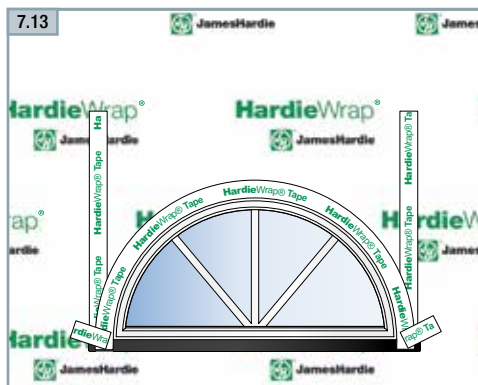


# Installation of HardieWrap® Pro-Flashing & Flex Flashing (cont.)

## CIRCULAR WINDOWS

Install circular top windows according to window manufacturer's installation guidelines, and then follow instructions as illustrated in figures 7.10 – 7.13 to complete the process.

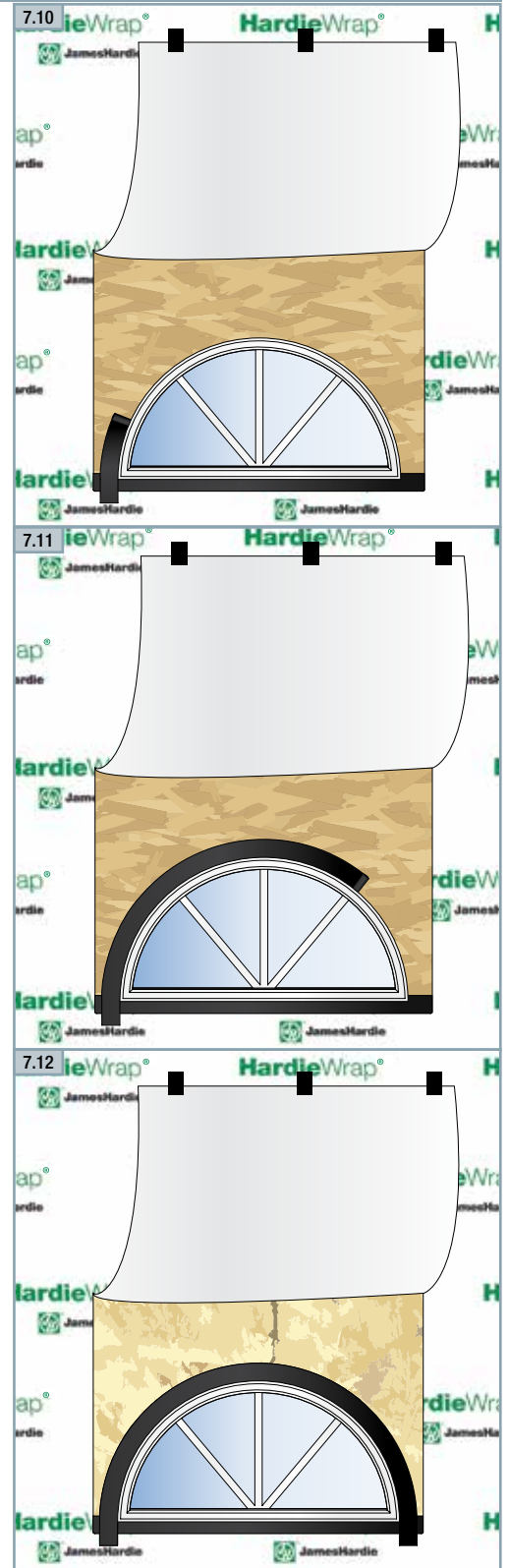
1. Measure the circular portion of the window and add 12 in. to this number. Cut HardieWrap® Flex Flashing to this length for the head flashing.
2. Remove approximately 20 in. of release paper and position HardieWrap® Flex Flashing tightly along the first edge of the round window. Press firmly into place (figs. 7.10 and 7.11).
3. Continue removing release paper and conform HardieWrap® Flex Flashing to entire circular portion of the window (fig. 7.12).
4. Use HardieWrap® Seam Tape or mechanical fasteners (i.e., nails, staples or screws) to temporarily hold top edge of head flashing to the wall.
5. HardieWrap® Flex Flashing adhesive bond will strengthen over time. Both ends of the head flashing should overlap the sill flashings by at least 6 in.

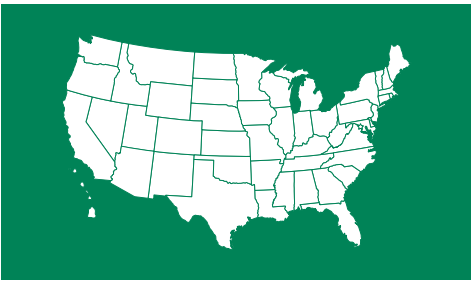


### IMPORTANT TO NOTE

These recommendations refer to the most commonly used types of windows (surface-mounted). For other types of frames, special attention should be paid to the window manufacturer's instructions.

A spray adhesive, such as Nashua 357, is recommended when HardieWrap® Flex Flashing is applied directly to Oriented Strand Board (OSB) or other surfaces where additional adhesion is needed or required.





# HardieWrap® Weather Barrier

EFFECTIVE APRIL 2018

**IMPORTANT: FAILURE TO INSTALL THIS PRODUCT IN ACCORDANCE WITH APPLICABLE BUILDING CODES AND WITH JAMES HARDIE WRITTEN APPLICATION INSTRUCTIONS MAY LEAD TO PERSONAL INJURY, AFFECT PERFORMANCE, VIOLATE LOCAL BUILDING CODES, AND VOID THE PRODUCT-ONLY WARRANTY.**

## HARDIEWRAP® WEATHER BARRIER PRODUCT DESCRIPTION

HardieWrap® weather barrier is a non-woven, non-perforated polyolefin water-resistive barrier, as per AC38, manufactured by James Hardie Building Products. HardieWrap weather barrier provides a balance of water resistance and breathability to protect homes from the elements of weather that can get behind the exterior wall cladding. HardieWrap® Pro Flashing and HardieWrap® Seam Tape are recommended in conjunction with HardieWrap weather barrier to complete the HardieWrap weather barrier solution.\*

A water-resistive barrier is required in accordance with local building code requirements. The water-resistive barrier must be installed with penetration and junction flashing, in strict accordance with local building code requirements.

## STORAGE

HardieWrap weather barrier should be stored in a covered area. Do not store in direct sunlight and do not expose to building site chemicals.

## GENERAL REQUIREMENTS - DESIGN

The installation guidelines herein are informational in nature only and may not be appropriate for use in all applications. It is the sole responsibility of the architect or specifier to identify moisture-related risks associated with any particular building design, and to make any appropriate adjustments or modifications to the installation guidelines herein. Wall- construction design must effectively manage moisture, considering both the interior and exterior environment of the building, particularly in buildings that have higher risks of wind-driven rain penetration and conditioned spaces. HardieWrap weather barrier may be installed on vertical wall applications only. James Hardie requires that HardieWrap weather barrier be covered within 180 days of installation. Wall openings, penetrations, junctions, connections, window sills, headers and jambs must incorporate appropriately installed HardieWrap Pro Flashing and HardieWrap Flex Flashing, or other flashing or flashing details, as recommended by the architect or specifier.

## INSTALLATION OF HARDIEWRAP® WEATHER BARRIER

HardieWrap weather barrier should be installed before window and door installation. It is not recommended to install HardieWrap weather barrier on saturated sheathing. HardieWrap weather barrier can become slippery and should not be used in any application where it may be walked on.

Begin by affixing weather barrier, extending at least 6 in. around a building corner (fig. 1). Unroll horizontally (with print side facing out) around the building, covering rough window and door openings. Fasten to studs or nailable sheathing material with galvanized construction-grade staples a maximum of 18 in. in the vertical and horizontal directions.

Attach weather barrier so that it is taut and flat. The vertical overlap must be a minimum of 6 in. and the vertical seam must be taped. HardieWrap Seam Tape is strongly recommended. Do not clog or interfere with the use of weep holes or similar drainage details.

Ensure that the bottom edge of the weather barrier extends over the sill plate and foundation interface by at least 1 in.

Overlap upper layers of weather barrier (in shingle lap fashion) by a minimum of 6 in. below the horizontal edge, and tape the horizontal seam line (fig. 1A).

\*The HardieWrap weather barrier solution is based on methods of installation from the AAMA and ASTM E2112. HardieWrap weather barrier helps to reduce the intrusion of moisture or air, but is not designed nor guaranteed to prevent the intrusion of all moisture or air.

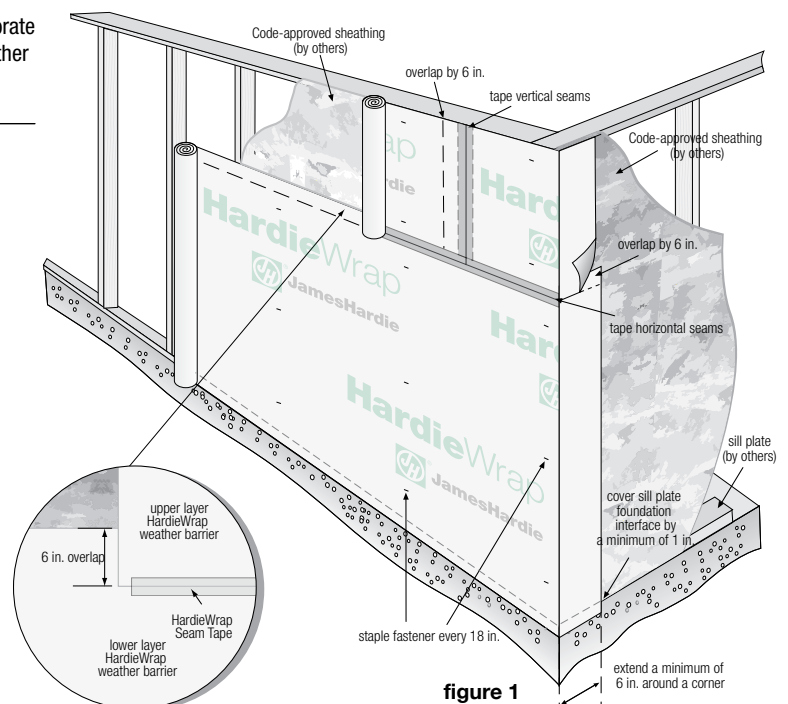


figure 1A

figure 1





### INSTALLATION OF HARDIEWRAP® WEATHER BARRIER (CONT.)

At roof-to-wall intersection (or wall-to-deck), affix wrap to the wall such that it overlaps any step flashing already on the wall by at least 2 in. (fig. 2).

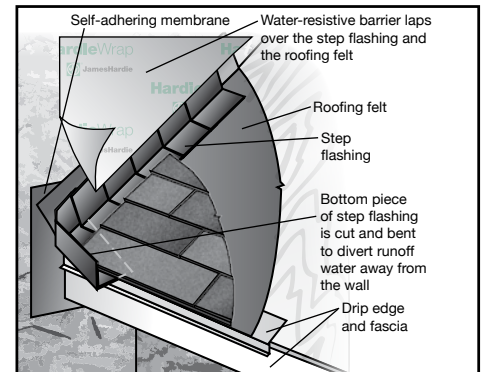


figure 2

### PRO FLASHING INSTALLATION

Pro Flashing is typically utilized at windows, doors, junctions and penetrations, and must be installed in conjunction with HardieWrap® weather barrier. Consult with the architect or specifier regarding the type and method of flashing to be utilized.

Check your local Building Code for construction requirements and follow the manufacturer's recommended installation instructions; or utilize standard practices for the installation of exterior windows and doors as referenced in ASTM E2112-01 or AAMA 2400-2 (CAWM 400-95). For specific flashing details and options, reference James Hardie's HardieWrap Pro Flashing Guide.

### WINDOWS AND OTHER PENETRATIONS

#### TYPICAL WINDOW INSTALLATION METHODS

HardieWrap weather barrier is not designed nor guaranteed to prevent moisture or air from intruding behind the weather barrier. Ensure that appropriate flashing has previously been installed around all windows and door openings.

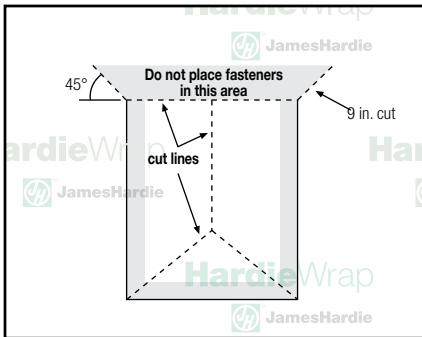


figure 3

**Step 1:** Use the inverted "Y" cut at rough window and door openings. Do not place fasteners within 9 in. of the rough opening, door or window heads. This area should not be fastened to allow for proper flashing installation. At the top corners of the rough opening, cut the weather barrier at 45° to extend 9 in. past the joint (fig. 3).

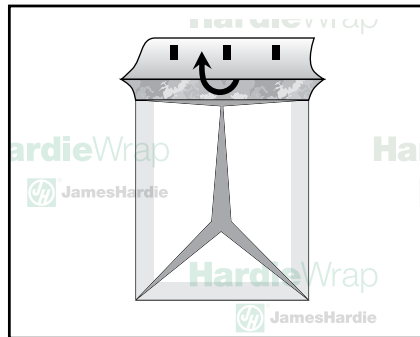


figure 4

**Step 2:** Fold the top flap up and out of the way and fasten temporarily (fig. 4).

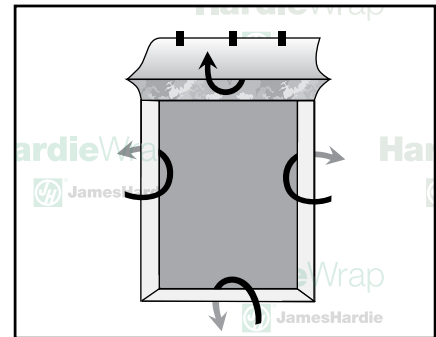


figure 5

**Step 3:** Fold the remaining three flaps in through the opening, fastening them inside with staples (fig. 5).

#### TYPICAL PENETRATION FLASHING METHODS

For rough electrical or plumbing penetrations, seal with flashing. Install the top piece over the bottom piece (figs. 7 and 8). HardieWrap Pro Flashing can be used for this application.

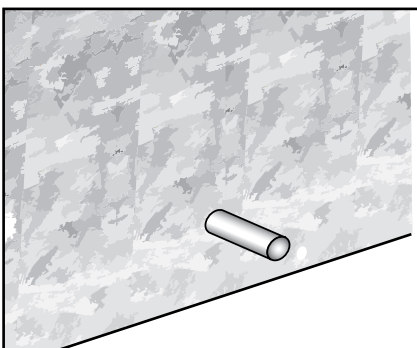


figure 6

The penetration detailed in figures 7 and 8 as found in the EEBA Water Management Guide.

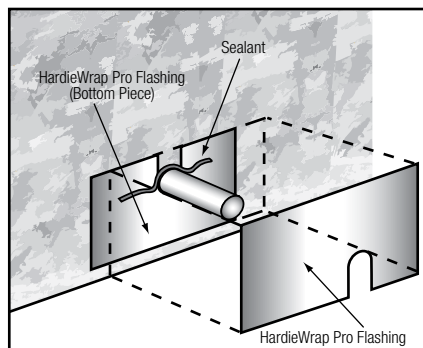


figure 7

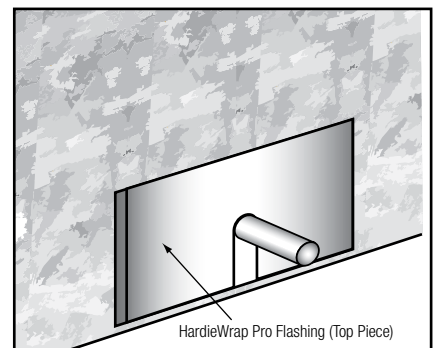


figure 8





## FASTENERS

Staples are the preferred and recommended fastening method. Fasten HardieWrap weather barrier in such a way that ensures the wrap is secured to the wall with staples a maximum of 18 in. O.C. (on center) in the vertical and horizontal direction. Staples should be construction-grade and must be galvanized.

When installing over insulation boards, use galvanized roofing nails long enough to penetrate insulation and framing studs or sheathing.

Consult with the architect or specifier regarding the need to seal any punctures caused by staples, nails or other items.

## REPAIRS

Staples are the preferred and recommended fastening method. Fasten HardieWrap weather barrier in such a way that ensures the wrap is secured to the wall with staples a maximum of 18 in. O.C. (on center) in the vertical and horizontal direction. Staples should be construction-grade and must be galvanized.

When installing over insulation boards, use galvanized roofing nails long enough to penetrate insulation and framing studs or sheathing.

Consult with the architect or specifier regarding the need to seal any punctures caused by staples, nails or other items.

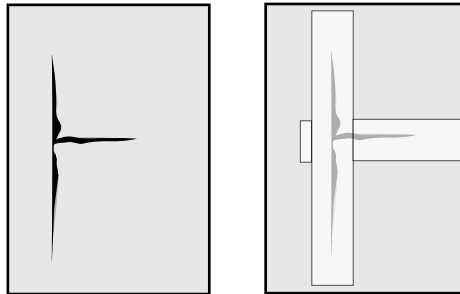


figure 9

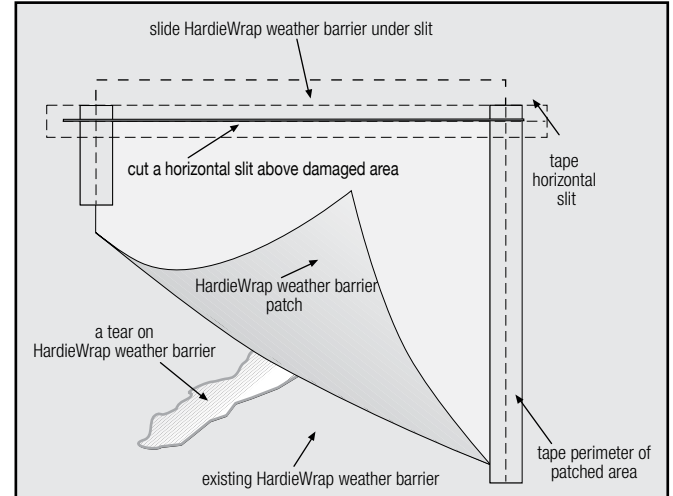


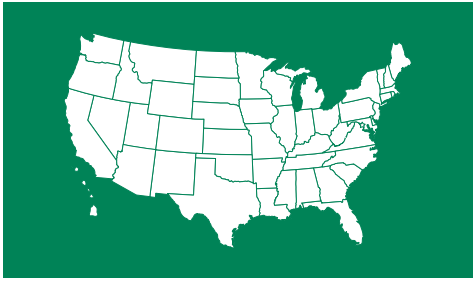
figure 10

## GENERAL REQUIREMENT CHECKLIST

- ✓ Do not store HardieWrap weather barrier in direct sunlight.
- ✓ It is recommended that weather barrier be installed over dry framing and sheathing.
- ✓ Tape all vertical and horizontal seams.
- ✓ Overlap subsequent weather barrier layers in shingle lap fashion with seams overlapping by at least 6 in.
- ✓ Be sure that all penetrations are addressed.
- ✓ Fasten with construction-grade galvanized staples a maximum of 18 in. in the vertical and horizontal directions.
- ✓ Repair punctures or tears, by the recommended practices.
- ✓ Do not use HardieWrap weather barrier in applications where it may be walked on.
- ✓ James Hardie requires that HardieWrap weather barrier be covered within 180 days of installation.

For further information consult James Hardie  
at 866-4HARDIE or [hardiewrap.com](http://hardiewrap.com)





# HardieWrap® ProFlashing

EFFECTIVE DECEMBER 2015

## HARDIEWRAP® PRO FLASHING PRODUCT DESCRIPTION

HardieWrap® ProFlashing and HardieWrap® Flex Flashing are high-performance, self-adhering, self-sealing, butyl material on tear-resistant top sheets that are applied around windows and doors to manage water and air intrusion. HardieWrap ProFlashing has a release liner for peel-and-stick installation and has no asphalt, VOCs or solvents.

HardieWrap® Flex Flashing is designed to easily stretch and seal around doors and windows, as well as custom shapes to protect against water intrusion, and is supplied in a convenient dispenser box. Together with HardieWrap® weather barrier and HardieWrap® Seam Tape, HardieWrap ProFlashing and HardieWrap Flex Flashing provide the James Hardie® weather barrier solution to manage water drainage, and prevent water damage and energy loss.

## STORAGE

For optimal performance, store in original sealed packaging at temperatures of 5° - 32°C (41° - 90°F) while at moisture-free conditions. James Hardie requires that HardieWrap ProFlashing and HardieWrap Flex Flashing be covered within 180 days of installation.

## IMPORTANT NOTICE

This recommendation refers to the most commonly used types of windows (surface-mounted). For other types of frames, special attention should be paid to the window manufacturer's instructions.

Check your local building code for construction requirements and follow the manufacturer's recommended installation instructions; or utilize standard practices for the installation of exterior windows and doors as referenced in ASTM E2112-01 or AAMA 2400-2 (CAWM 400-95). Consult with the architect or specifier regarding the methods to be utilized.

## GENERAL REQUIREMENT

The installation guidelines herein are informational in nature only and may not be appropriate for use in all applications. It is the sole responsibility of the architect or specifier to identify moisture-related risks associated with any particular building design, and to make any appropriate adjustments or modifications to the installation guidelines herein. Wall-construction design must effectively manage moisture, considering both the interior and exterior environment of the building, particularly in buildings that have a higher risk of wind-driven rain penetration and conditioned spaces. Wall openings, penetrations, junctions, connections, window sills, headers and jambs must incorporate appropriately installed HardieWrap™ Pro Flashing and HardieWrap™ Flex Flashing, or other flashing or flashing details, as recommended by the manufacturer, architect or specifier.



HardieWrap ProFlashing



HardieWrap Flex Flashing



HardieWrap® Seam Tape







### HARDIEWRAP® FLEX FLASHING STRETCHABLE SILL FLASHING

Prepare sill flashing by cutting HardieWrap® Flex Flashing at least 12 in. longer than the width of the rough opening. Install sill flashing by removing the release paper, centering sill flashing on sill framing stud and adhering into rough opening. The back edge of HardieWrap Flex Flashing should extend to the inside edge of sill framing stud and at least 6 in. up each jamb framing stud. (Note: Sill flashing should not wrap onto the inside of wall.) DO NOT STRETCH MATERIAL ALONG THE SILL OF JAMB. HardieWrap Flex Flashing should be applied over the water-resistive barrier after it has been cut and set into and around the window rough opening.

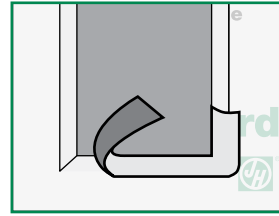


figure 1

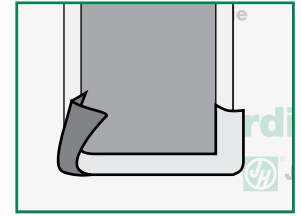


figure 2

Note: If a water-resistive barrier is to be applied after the window and flashing have already been installed, be sure not to fasten the lower edge of the flashing so that the water-resistive barrier may be slipped underneath the flashing in weather-board or shingle-lap (top layer overlapping bottom layer) fashion.

### WINDOW INSTALLATION

Before installing the window, (a) apply a continuous bead of sealant to the backside (interior) of the window's mounting flange on the outer edge; or (b) apply a continuous seal to the rough opening to ensure contact with the backside (interior) of the window's mounting flange (do not caulk along bottom). Install window according to the manufacturer's installation procedures.

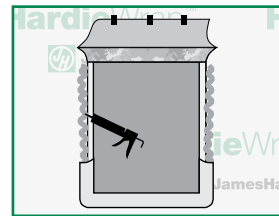


figure 3

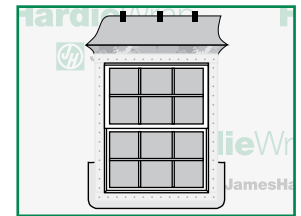


figure 4

### SIDE JAMB FLASHING

Apply HardieWrap® ProFlashing along the vertical sides of the opening. Flash over the side window mounting flanges. Extend the flashing by a minimum of 3 in. beyond the sill flashing (HardieWrap Flex Flashing) already in place and extend the flashing to a minimum of 3 in. beyond the top of the opening, so that it projects beyond the head flashing that is to be applied later.

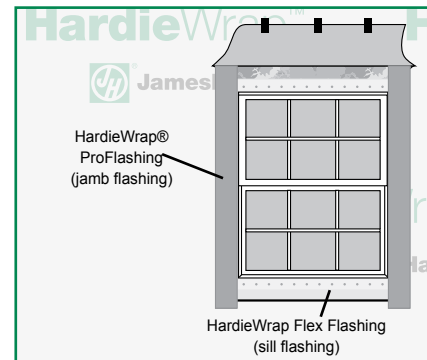


figure 5

### HEAD FLASHING

Affix HardieWrap® Pro Flashing over the window's mounting flange along the header opening. Be sure to extend the flashing beyond each jamb flashing by 3 in. Secure flashing in place by applying pressure. Detach weather barrier flap (top) and apply over head flashing as shown. Tape all seams and joints.

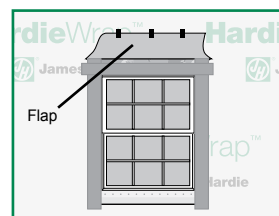


figure 6

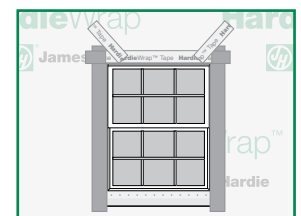


figure 7

### IMPORTANT NOTE

If windows/door are pre-existing then go to section: Pre-existing windows/doors.





### CIRCULAR WINDOWS

Follow previous instructions for proper installation prior to head flashing installation. Install circular top windows according to window manufacturer's installation guidelines, and then follow instructions as illustrated in figures 8–11 to complete the process.

Measure the circular portion of the window and add 12 in. to this number. Cut HardieWrap® Flex Flashing to this length for the head flashing. Remove approximately 20 in. of release paper and position HardieWrap® Flex Flashing tightly along the first edge of round window. Press firmly into place (figs. 8 and 9). Continue removing release paper and conform HardieWrap Flex Flashing to entire circular portion of window (fig. 10). Use HardieWrap® Seam Tape or mechanical fasteners (i.e., nails, staples or screws) to temporarily hold top edge of head flashing to wall. HardieWrap Flex Flashing adhesive bond will strengthen over time. Both ends of head flashing should overlap sill flashings by at least 6 in.

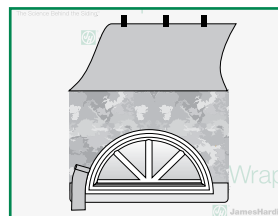


figure 8

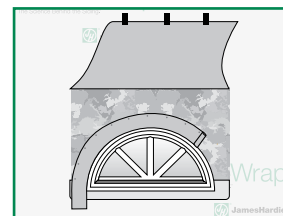


figure 9

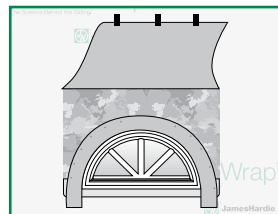


figure 10

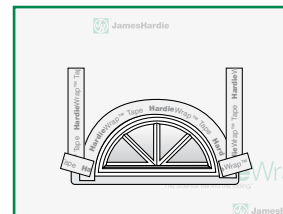


figure 11

### IMPORTANT TO NOTE

This recommendation refers to the most commonly used types of windows (surface-mounted). For other types of frames, special attention should be paid to window manufacturer's instructions.

A spray adhesive, such as Nashua 357, is recommended when HardieWrap Flex Flashing is applied directly to Oriented Strand Board (OSB) or other surfaces where additional adhesion is needed or required.

### PRE-EXISTING WINDOWS/DOORS

When installing HardieWrap weather barrier after windows and doors have already been installed and flashed, follow these additional 2 steps

#### Step 1

- Cut HardieWrap weather barrier around the openings to expose the window/door and apron as shown (fig.12).
- Do not cut into the flashing or apron.

#### Step 2

- Tape vertical seams as shown using HardieWrap seam tape (fig.13).
- Do not tape at the bottom of the window/door
- Tape the head seam as shown (fig.14).

Note: It is acceptable to skip taping of the head if additional drainage is desired.

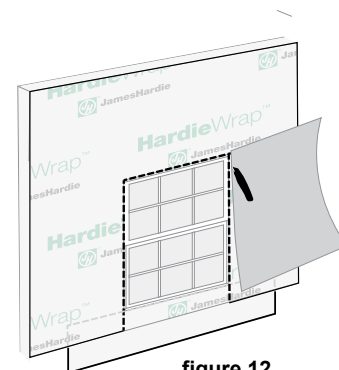


figure 12

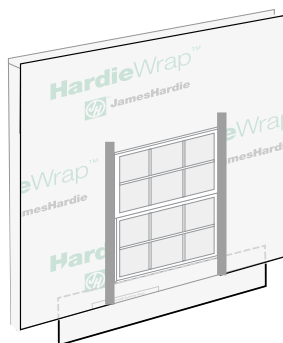


figure 13

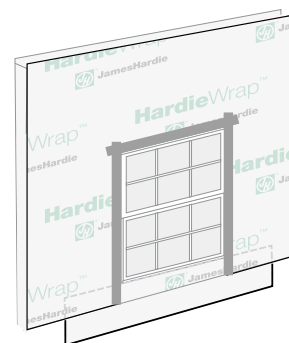


figure 14

For further information consult James Hardie at 866-4HARDIE or hardiewrap.com



## HardieTrim® Boards Products Description

HardieTrim® boards come finished with either the PrimePlus® factory primer and sealer or with ColorPlus® Technology. The ColorPlus® coating is a factory-applied, oven-baked finish available on a variety of James Hardie® siding and trim products. See your local dealer for details and availability of products, colors, and accessories.

### HARDIETRIM® 5/4, 4/4 BOARDS

HardieTrim® 5/4, 4/4 board is a decorative non-load bearing trim product. HardieTrim 5/4 board is 1 in. thick, HardieTrim 4/4 board is 3/4 in thick, and both can be purchased in 10 ft. and 12 ft. lengths, based on local availability. In addition to frieze, rake, window, door, and corner details, HardieTrim 5/4, 4/4 boards may be used to construct light blocks, column wraps and decorative scroll work. Available in commonly-used nominal widths from 4 in to 12 in.

### HARDIETRIM® BATTEN BOARDS

HardieTrim® Batten Boards are a decorative non-load bearing trim product. HardieTrim® Batten Boards are 3/4 in. thick, 2 1/2 in. wide, and come on 12 ft. lengths. See your local dealer for details and availability of product colors and accessories.



HardieTrim 5/4, 4/4 board - Smooth



HardieTrim Batten board - Rustic and Smooth (not shown)



HardiePanel vertical siding with HardieTrim Batten board for the Board & Batten look.

### A Complete James Hardie Exterior – Close-up on trim products.



*ColorPlus TIP: HardieTrim 4/4, 5/4 boards with ColorPlus Technology is shipped with a protective laminate slip sheet. James Hardie recommends keeping the protective sheet in place during cutting and fastening to reduce damage to the boards. Remove the protective sheet only after installing the boards and filling the nail holes with a colored touch-up pen.*



## WARNING

**DO NOT caulk nail heads when using ColorPlus products. Refer to the ColorPlus touch-up section**

# Installation of HardieTrim® 5/4, 4/4 & NT3® Back Grooved Boards

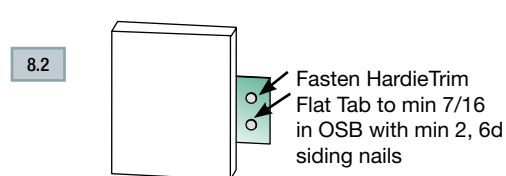
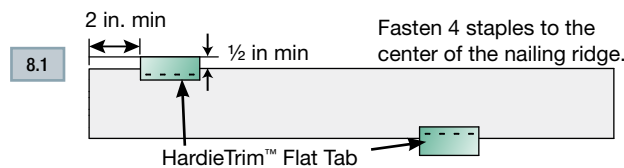
## CONCEALED FASTENING TABS

For Corners, Band Boards, Windows, and Door Applications: HardieTrim® boards can be installed with Flat Tabs (JH sku no. 280154) and Corner Tabs (JH sku no. 280155) which provide concealed fastening. Only Flat and Corner Tabs can be used with HardieTrim® boards to create a concealed fastening. Additional framing may be required to ensure the Flat and Corner Tabs are fastened properly to the structure. Special attention should be paid to the framing when using a sheathing that does not have fastener holding equivalent to OSB or Plywood sheathing.

Step 1: Attach Flat Tabs to the back side of the trim with 4 18 ga. ½ in L x ¼ in W narrow crown corrosion resistant staples, equally spaced in one row, positioned no closer than ½ in from trim edges, using a pneumatic staple gun. (Figure 8.1)

Step 2: For wood frame construction, attach the trim to the building using 2, 6d siding nails fastened through the Flat Tabs. ET&F or equivalent fasteners may be used to attach the Flat Tabs to steel frame construction. (Figures 8.2)

Fastener spacing will vary based on application. Refer to specific sections in these instructions for required fastener spacing by application (window, band board, etc.). (Figures 8.14)



Installation of HardieTrim tabs in Coastal Regions:

James Hardie requires that stainless steel staples & fasteners be used when installing HardieTrim™ Tabs in coastal regions.

Installation of HardieTrim Tabs over Pressure Treated Lumber:

HardieTrim™ tabs shall not come in direct contact with ACQ or CA preservative-treated wood. Refer to the General Fastening section of this document for further information.

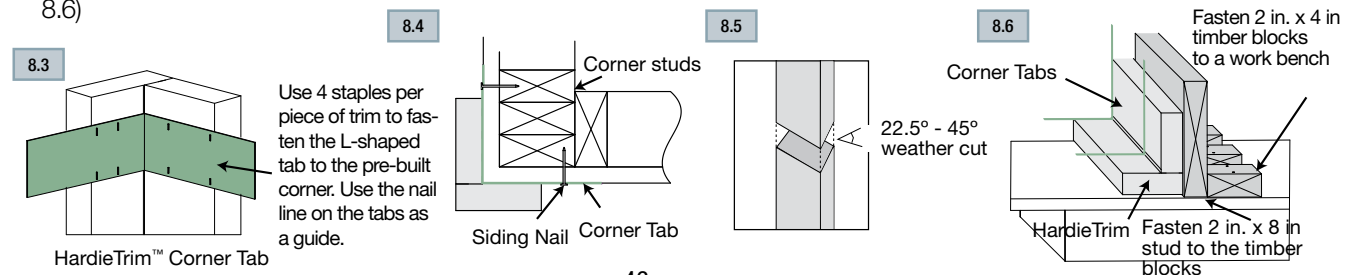
HardieTrim NT3® ColorPlus® boards with back grooves:

Remove the laminate sheet as soon as possible after attaching the trim to the building.

## TRIMMING CORNERS

HardieTrim® boards are installed around corners by pre-building the corner off the wall with the Corner Tabs (JH sku no. 280155).

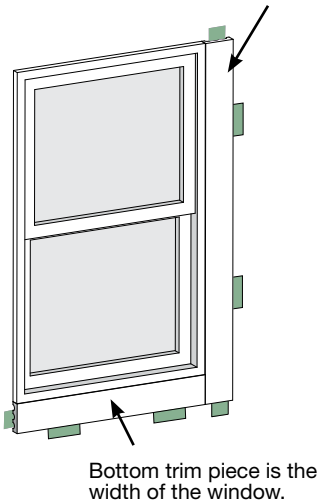
- Attach Corner Tabs to the back side of the trim with 8 18 ga. 1/2 in. L x 1/4 in W narrow crown corrosion resistant staples using a pneumatic staple gun. Ensure the Corner Tabs are fastened tight and straight to the trim boards. (Figures 8.3)
- For wood frame construction, attach the trim to the building with 2, 6d siding nails fastened through the Corner Tabs. ET&F or equivalent fasteners may be used to attach the Corner Tabs to steel frame construction. (Figures 8.4)
- Attach a Corner Tab 1 in. from each edge and every 20 in o.c.
- TIP: Creating a jig for the work station is recommended to ensure the corners are fastened securely and straight. (Figures 8.6)



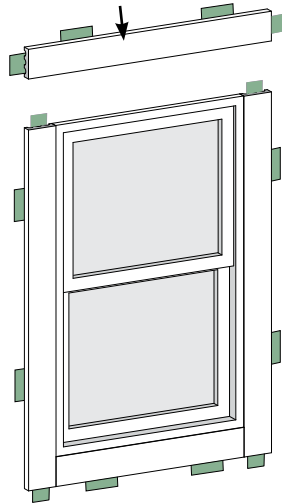
## TRIM APPLICATION FOR WINDOWS, DOORS & OTHER OPENINGS

Trim the opening prior to the installation of the siding (Figure 8.7). Place a Flat Tab at the end of each trim board and one tab every 16 in OC. Attach the trim boards and Flat Tabs around the opening as shown in Figures 8.7 and 8.8.

8.7 Side trim pieces go to the top of the window.

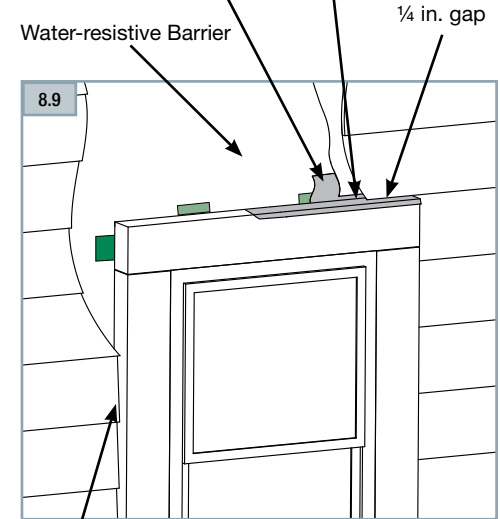


8.8 Header piece spans the window including the side trim pieces.



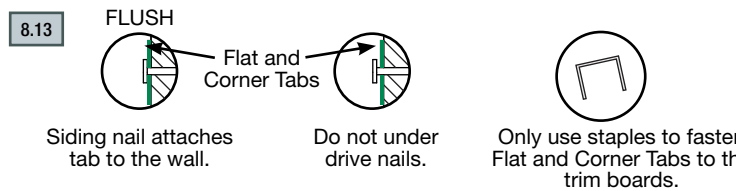
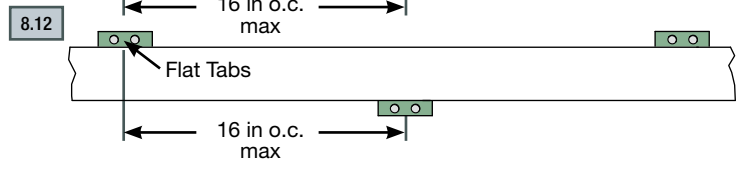
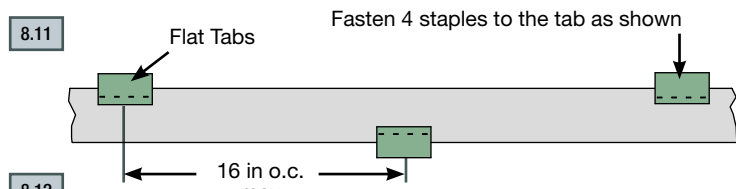
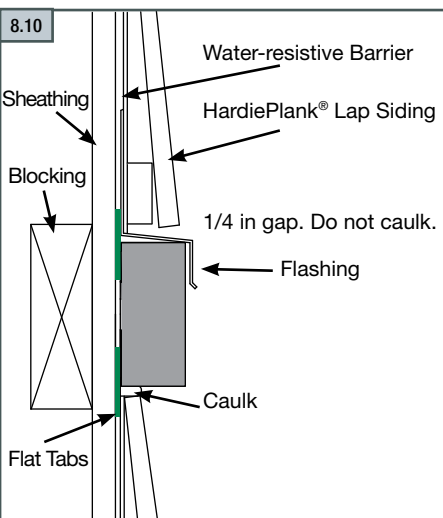
NOTE: Follow your window/door manufacturers installation instructions.

Flashing needs to be tucked under the water resistive barrier and over the Flat Tabs. Do not caulk between the siding and the flashing.



## BAND BOARD

A flashing is required over the trim and Flat Tabs. (Figure 8.10) Terminate ends of the Band Board into Trim or Siding or miter cut the edges of the trim at the corners of the building. Place a Flat Tab at the end of each trim board and one tab every stud at a maximum of 16 in. o.c. The Flat Tabs should be attached to the trim in an alternating pattern to the top and bottom of the band board (Figures 8.11 and 8.12).





# Installation of HardieTrim® 5/4, 4/4 & NT3® Back Grooved Boards

## FASTENER TABLE

8.14

Application	Framing Material Tab is nailed into	Fastener (tab to framing)	Fastener (tab to Hardietrim)	Max Tab Spacing (inches on center)
Flat Tab	Wood Stud (minimum G=0.42)	One 6d corrosion resistant siding nail installed through center of flange into framing	Four 18 ga. X 1/2" long X 1/4" wide corrosion resistant crown staples, equally spaced in one row	16
	Minimum APA rated 7/16" OSB	Two 4d ring shank corrosion resistant siding nails equally spaced installed through flange into framing		
	Minimum 20 gauge steel	One No. 8 X 1" long X 0.323" head diameter screw (corrosion resistant) installed through flange into framing		
Corner Tab	Wood Stud (minimum G=0.42)	On each flange, Install one 6d corrosion resistant siding nail through flange into framing	For each piece of trim, install Four 18 ga. X 1/2" long X 1/4" wide corrosion resistant crown staples, equally space in two rows	20
	Minimum APA rated 7/16" OSB	On each flange, Install two 4d ring shank corrosion resistant siding nails through flange into framing		
	Minimum 20 gauge steel	On each flange, Install one No. 8 X 1" long X 0.323" head diameter screw (corrosion resistant) through flange into framing		

Wind-Borne Debris Region: "Supplemental fasteners may be necessary when installing tabs in a Wind-Borne Debris Region, please call Technical Services 800-942-7343 with any questions."

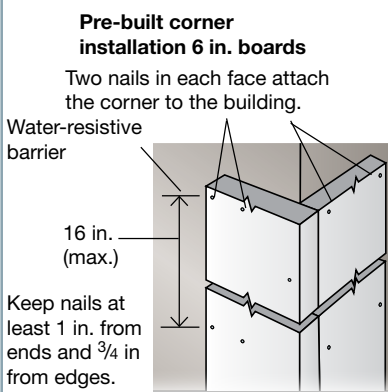
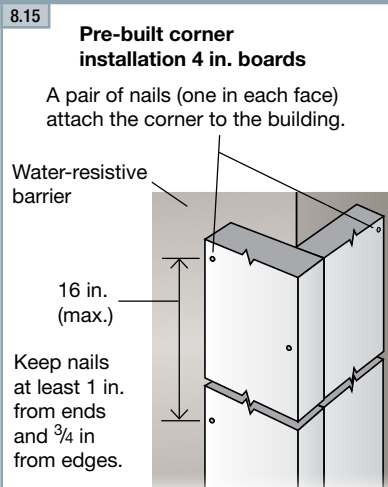
**RECOGNITION:** HardieTrim boards may be installed as an equal alternative to conventional trim permitted for use in; the 1997 Uniform Building Code, Section 601.5.5; the 1997 Standard Building Code, Section 1404.1; the 1999 BOCA National Building Code, Section 1407.2.2; 2003 International Building Code, Section 1402.1, the 2003 International Residence Code for One - and Two - Family - Dwellings, Section R703.1. the 2003 International Residence Code for One - and Two - Family - Dwellings, Section R703.1. and the 1998 International One-and -Two -Family Dwelling Code, Section 601.1.

## OUTSIDE CORNERS

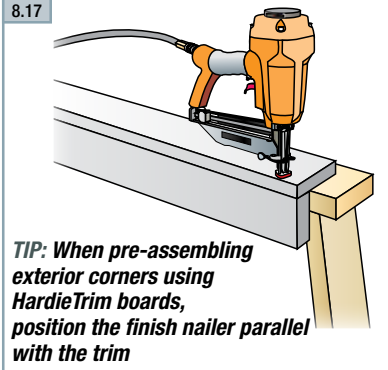
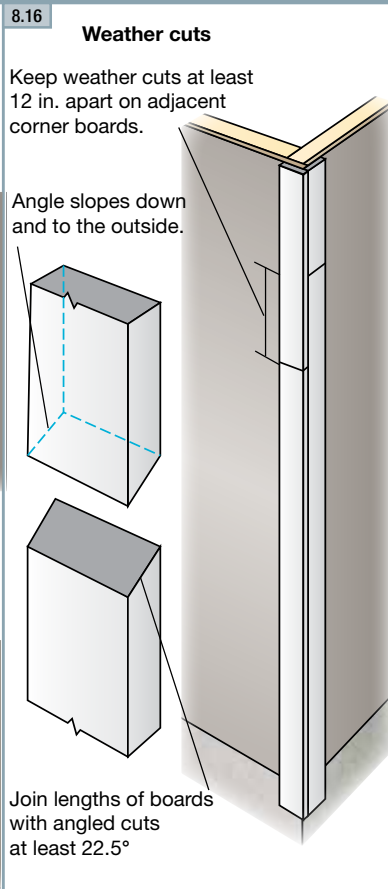
Corners made from HardieTrim® 5/4, 4/4 boards can be pre-assembled before they're installed. Pre-assembled corners look better and generally make the installation go more quickly. To join two pieces of HardieTrim 5/4, 4/4 boards for a corner, drive 2 in. 16 ga. corrosion-resistant finish nails 1/2 in. from the edge and spaced 16 in. apart along the edge.

To fasten 4 in. corners to the wall, drive a pair of finish nails or siding nails, (one nail into each face of the corner) with the nails spaced 16 in. apart. For 6 in. corners, drive a pair of finish nails or siding nails into each face spaced 16 in. apart. Nails should be kept 3/4 in. from the edges of the board and 1 in. from the ends.

When walls are more than 10 ft high, splice corner boards together using weather cuts of at least a 22.5° angle. The angle of the weather cut must slope downward and away from the building. Then nail both boards to the building with the same attachment schedule as for pre-assembled corners, except that 4 in. HardieTrim 5/4, 4/4 boards that should get two nails per side every 16 in. Only install trim by butting to it with the siding. Do not install any trim product over James Hardie® siding.



**NOTE:** All weather cut joints should be touched up prior to installation.

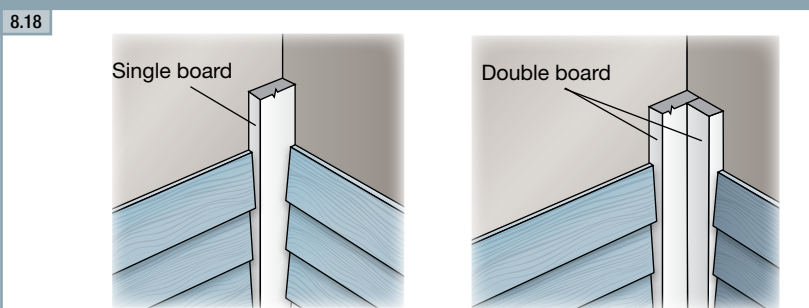


**WARNING**

Use only 2 in. 16-ga. finish nails to pre-assemble HardieTrim 5/4 boards corners.

## INSIDE CORNERS

Inside corners can be made with either a single HardieTrim 5/4, 4/4 board in the corner, or with one board on each wall depending on the desired look.



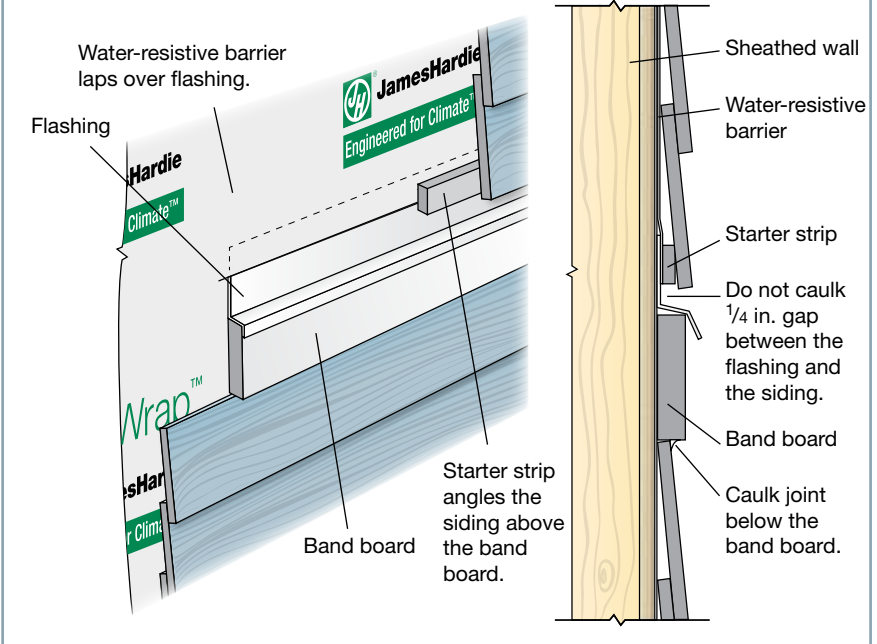
# Installation of HardieTrim® 5/4, 4/4 & NT3® Back Grooved Boards

## BAND BOARD

A Band board is a decorative horizontal trim used to break up the field of siding on a building. Any width of HardieTrim® 5/4, 4/4 boards can be used for band board depending on the type of detail desired. If installing a band board, pay special attention to flashing details and allow for potential shrinkage of solid rim joists in the walls that the band board may be attached to.

Caulk between the underside of the band board and the siding below. Do not caulk between the flashing and siding above the band board, and maintain a 1/4 in. gap between the two. Also make sure that the water-resistive barrier laps over the flashing for a continuous

8.19

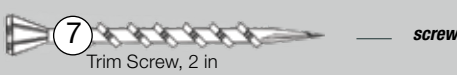
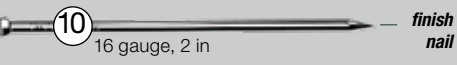
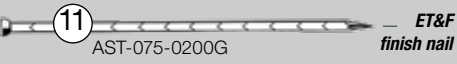
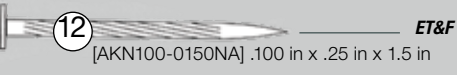


drainage plane. If running lap siding or shingle siding above the band board, a starter strip should be installed first to maintain the correct siding angle. Small Periodic gaps should be left in the starter strip to provide an escape route for excess moisture that may drain down behind the siding.

Use bevel-cut splice joints of at least 22.5° to join long lengths of HardieTrim 5/4, 4/4 boards. To attach band board to the building, drive two recommended fasteners every 16 in. for 4 in. and 6 in. boards. For 8 in. boards, use three fasteners every 16 in., and use four fasteners every 16 in. for 12 in. boards.

## HARDIETRIM BOARDS FASTENER SPECIFICATIONS

The Fastener Specifications table shows fastener options for a variety of different nailing substrates. Please refer to the applicable ESR report online (see back page) to determine which fastener meets your wind load design criteria.

Fastening Substrate	Approved Fastener	Fastening Types	Nailing Patterns
wood studs	10	 Trim Screw, 2 in — screw	<b>Pre-built corners</b> 4 in. 1 nail every 16 in to attach boards together 6 in. 1 nail every 16 in for each board 6 in. 1 nail every 16 in to attach boards together 2 nails every 16 in for each board
over minimum 7/16 in OSB	10	 16 gauge, 2 in — finish nail	
steel studs	7 12 11	 AST-075-0200G — ET&F finish nail	<b>Site-built corners &amp; other areas (eg. windows, etc.)</b> 4 in. & 6 in. 2 nails every 16 in 8 in. 3 nails every 16 in 12 in. 4 nails every 16 in
Pre-built corners	10	 [AKN100-0150NA] .100 in x .25 in x 1.5 in — ET&F	

10 indicates recommended fasteners

TIP: James Hardie recommends using stainless steel finish nails when installing HardieTrim (Trim, Battens, Fascia, etc.) products.

## WINDOW AND DOOR TRIM

Windows and doors must be installed per the manufacturer's instructions. Window flanges or flashings must be properly installed and lapped correctly under the water-resistant barrier prior to the installation of HardieTrim® 5/4, 4/4 boards. Once the HardieTrim 5/4, 4/4 boards is put on, proper flashing must be installed above the trim and lapped under the water-resistant barrier correctly.

Install HardieTrim 5/4, 4/4 boards around doors and windows using the "cap over" method, which means that the header or horizontal top piece of the trim extends and caps over the vertical jamb pieces on both sides. For windows, the bottom trim piece or sill trim fits in between the jambs.

For cap-over trim installation:

1. Start by measuring the length of the bottom edge of the window, not including the flange.
2. Cut a piece of trim to that length and install it.
3. Next measure from the bottom of the installed trim to the top of the window.
4. Cut two pieces of trim to that length and install them on either side of the window.
5. For the cap, measure the distance between the outside edges of the side trim pieces. Cut a piece of trim to length and install it.

For doors the process is the same except that it starts with the side pieces, step three.

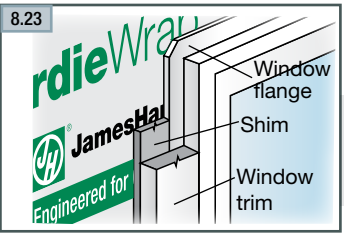
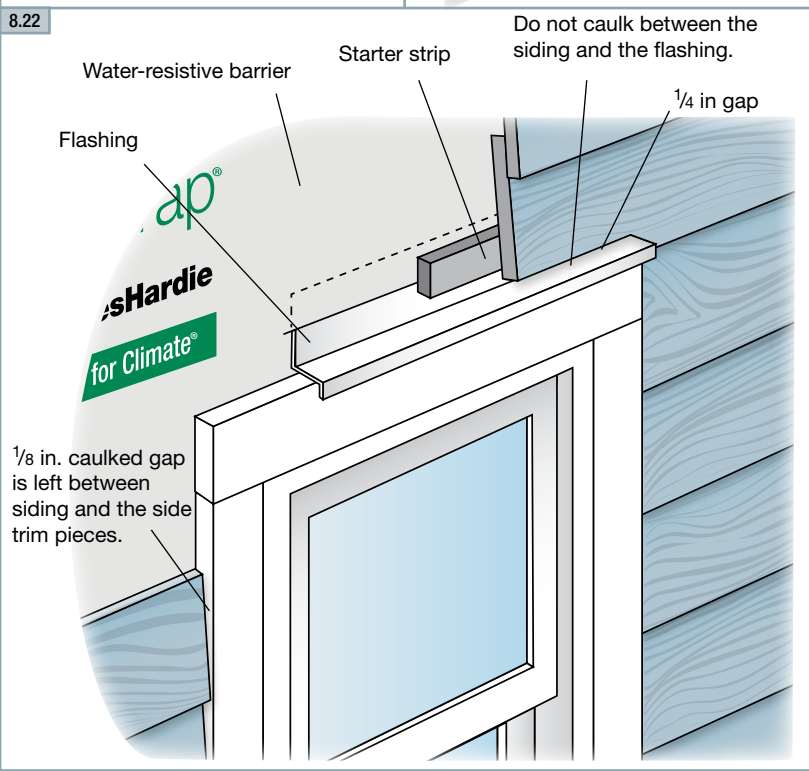
8.20 Window and door trim



8.21



8.22



**TIP:** For trimming around windows and doors with attachment flanges, install a shim strip to build out the wall even with the flange. This strip lets the trim sit flat and parallel with the wall.

# Installation of HardieTrim® 5/4, 4/4 & NT3® Back Grooved Boards

## INSTALLING RAKE AND FASCIA BOARD

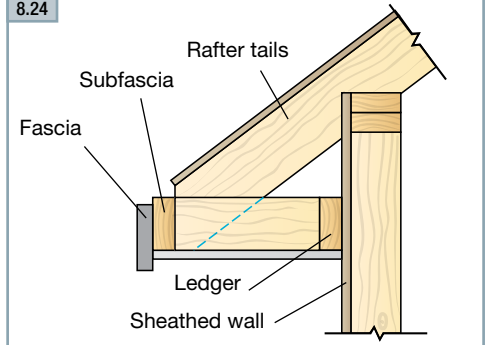
HardieTrim boards can be fastened directly over a 2x sub-fascia or directly to rafter tails. Check local building code for relevant codes. James Hardie recommends that the fascia be no more than 2 in. larger than the subfascia, e.g. over a nominal 2 x 6 subfascia, install an 8 in. fascia board (7¼ in. actual) fascia. On longer fascia runs, join HardieTrim boards with weather/bevel cuts.



### WARNING

Use only 2 in. 16-ga. finish nails to pre-assemble HardieTrim 5/4, 4/4 board corners.

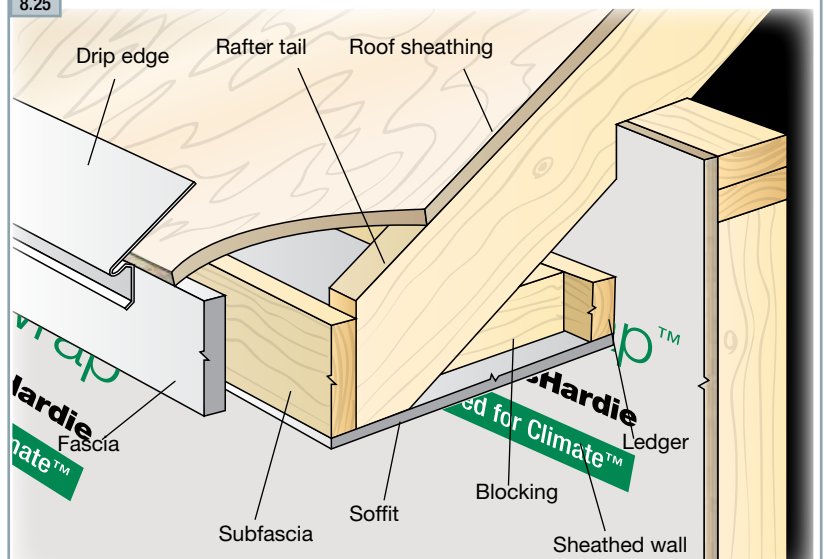
8.24



## DRIP EDGE

After the fascia is installed, a vinyl, coated aluminum or galvanized drip-edge flashing must be installed to the roof sheathing overlapping the fascia board. The drip edge helps protect the top edge of the fascia board and it minimizes water ingress into the soffit and/or cornice cavity. Choose a drip edge design that effectively channels water away from the face of the fascia and into gutters if present.

8.25

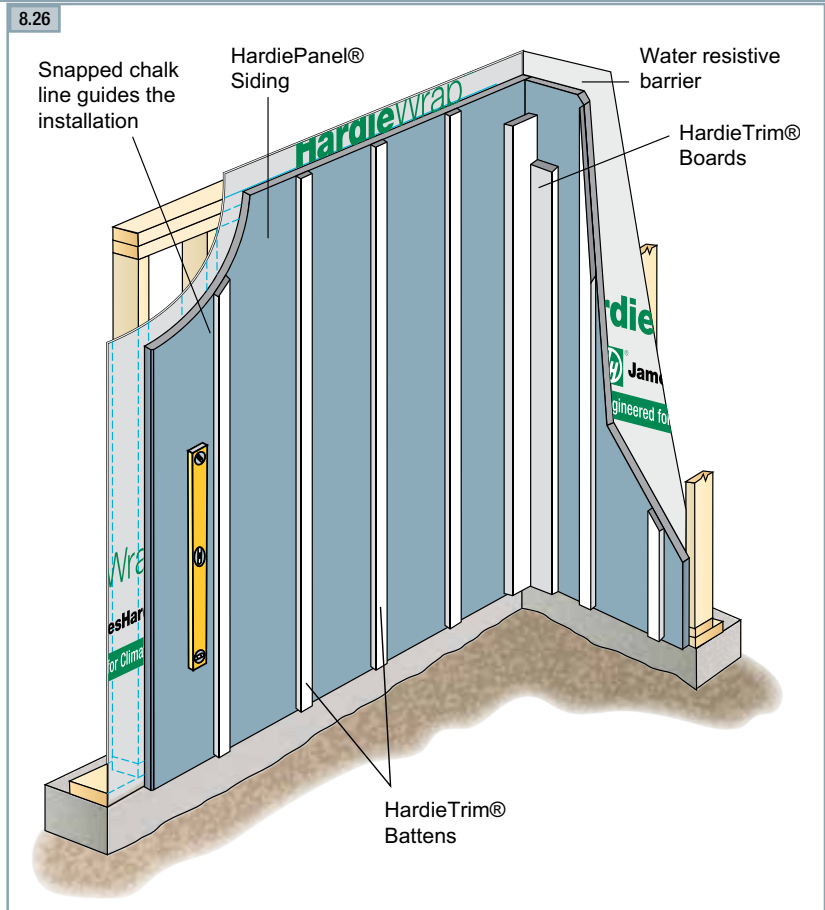




# Installation of HardieTrim® Battens

## GETTING STARTED

HardieTrim® Battens are intended to be used with HardiePanel® vertical siding to achieve a board and batten look. HardieTrim Battens must be attached to wood or steel backing using an approved fastener from the table below. When installing HardieTrim Battens, determine layout and mark where battens will be attached. To ensure that HardieTrim Battens are installed vertically and parallel to each other, either snap chalk lines or use a level. When attaching battens ensure that fasteners are a minimum of 3/4 in. from edges, 1 in. from ends, and a maximum of 16 in. o.c.



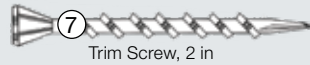
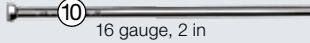
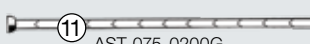

### ColorPlus® TIP:

HardieTrim Battens with ColorPlus® Technology are shipped with a protective laminate slip sheet. James Hardie recommends keeping the protective sheet in place during cutting and fastening to reduce damage to the boards. Remove the protective sheet only after installing the boards and filling the nail holes with a colored touch-up pen. Finish nails are required for ColorPlus products.



## HARDIETRIM BATTENS FASTENER SPECIFICATIONS

The Fastener Specifications table shows fastener options for a variety of different nailing substrates. Please refer to the applicable ESR report online (see back page) to determine which fastener meets your wind load design criteria.

Fastening Substrate	Approved Fastener	Fastener Types
wood studs	10	 <span style="float: right;">screw</span> Trim Screw, 2 in
over minimum 7/16 in OSB	10	 <span style="float: right;">finish nail</span> 16 gauge, 2 in
steel studs	7 12 11	 <span style="float: right;">ET&amp;F finish nail</span> AST-075-0200G
		 <span style="float: right;">ET&amp;F</span> [AKN100-0150NA] .100 in x .25 in x 1.5 in

● Indicates recommended fasteners. Required for ColorPlus Products.

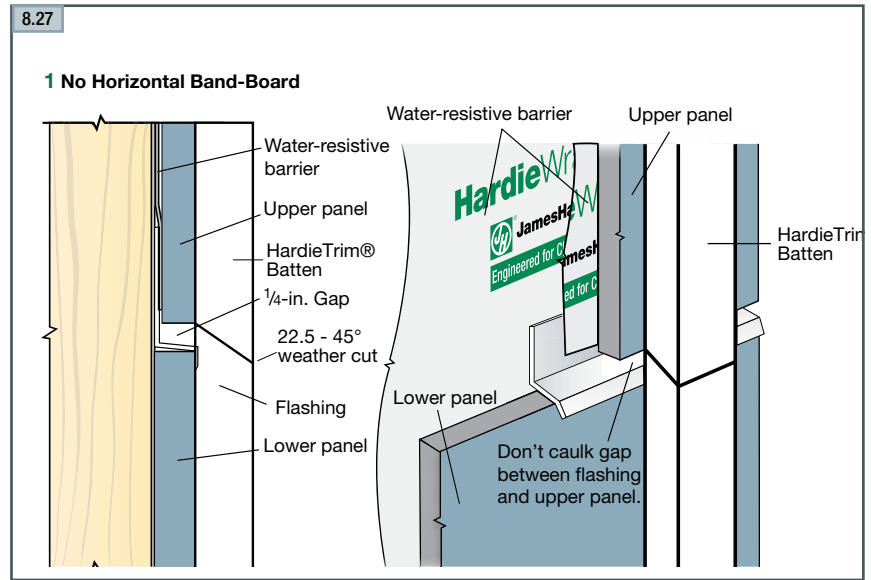
TIP: James Hardie recommends using stainless steel finish nails when installing HardieTrim (Trim, Battens, Fascia, etc.) products.

# Installation of HardieTrim® Battens (cont.)

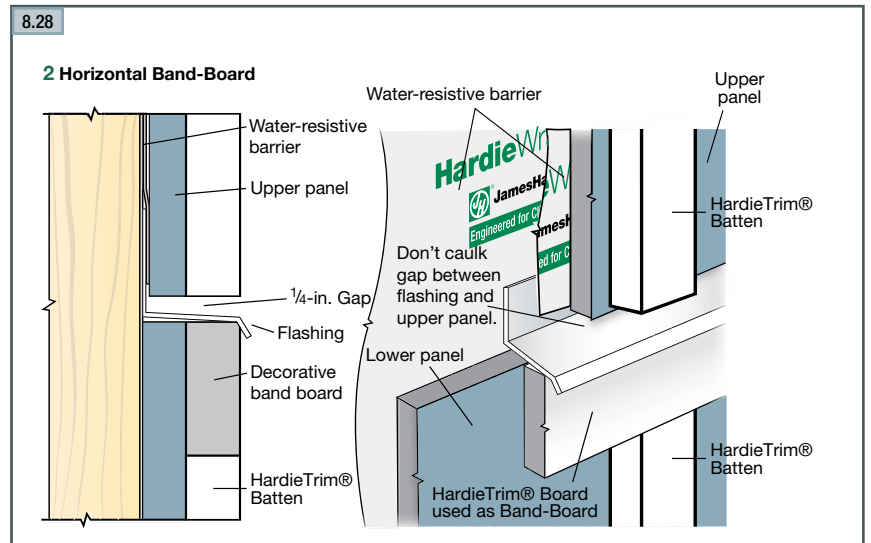
## HORIZONTAL JOINT TREATMENT

Horizontal HardieTrim® Batten joints must occur at the same location as horizontal joints in HardiePanel® siding. Install horizontal HardieTrim Batten joints by using one of the following options:

1. If HardieTrim Battens are going to be installed over horizontal panel joints without the use of a horizontal band board, follow the procedure as illustrated in fig. 8.27. Start installing HardieTrim Battens by creating a weather-cut of at least a 22.5° angle, making a joint at the same location as the panel joint. Attach the bottom batten. Make sure the top batten has a matching weather-cut and then install top batten.



2. If HardieTrim Battens are to be installed over horizontal panel joints with the use of a horizontal band board, follow the procedure as illustrated in fig. 8.28. If HardieTrim Battens are to be installed horizontally, they must be installed in the same manner as in fig. 8.28. Make sure the horizontal Z-flashing is installed over both the lower panel and the horizontal band board. Attach the bottom batten tight to the bottom edge of the band board. Next, leaving a minimum 1/4 in. gap above the horizontal Z-flashing, install the top batten.



## WARNING

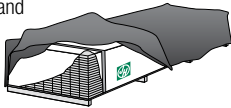
**Do not bridge floors with HardieTrim Battens and/or HardiePanel Siding. A horizontal joint should always be created between floors.**



**IMPORTANT: FAILURE TO FOLLOW JAMES HARDIE WRITTEN INSTALLATION INSTRUCTIONS AND COMPLY WITH APPLICABLE BUILDING CODES MAY VIOLATE LOCAL LAWS, AFFECT BUILDING ENVELOPE PERFORMANCE AND MAY AFFECT WARRANTY COVERAGE. FAILURE TO COMPLY WITH ALL HEALTH AND SAFETY REGULATIONS WHEN CUTTING AND INSTALLING THIS PRODUCT MAY RESULT IN PERSONAL INJURY. BEFORE INSTALLATION, CONFIRM YOU ARE USING THE CORRECT HARDIEZONE® PRODUCT INSTRUCTIONS BY VISITING HARDIEZONE.COM OR CALL 1-866-942-7343 (866-9-HARDIE)**

**STORAGE & HANDLING:**

Store flat and keep dry and covered prior to installation. Installing siding wet or saturated may result in shrinkage at butt joints. Carry planks on edge. Protect edges and corners from breakage. James Hardie is not responsible for damage caused by improper storage and handling of the product.



**⚠ CUTTING INSTRUCTIONS**

**OUTDOORS**

1. Position cutting station so that airflow blows dust away from the user and others near the cutting area.
2. Cut using one of the following methods:
  - a. Best: Circular saw equipped with a HardieBlade® saw blade and attached vacuum dust collection system. Shears (manual, pneumatic or electric) may also be used, not recommended for products thicker than 7/16 in.
  - b. Better: Circular saw equipped with a dust collection feature (e.g. Roan® saw) and a HardieBlade saw blade.
  - c. Good: Circular saw equipped with a HardieBlade saw blade.

**INDOORS**

- DO NOT grind or cut with a power saw indoors. Cut using shears (manual, pneumatic or electric) or the score and snap method, not recommended for products thicker than 7/16 in.
- DO NOT dry sweep dust; use wet dust suppression or vacuum to collect dust.
  - For maximum dust reduction, James Hardie recommends using the "Best" cutting practices. Always follow the equipment manufacturer's instructions for proper operation.
  - For best performance when cutting with a circular saw, James Hardie recommends using HardieBlade® saw blades.
  - Go to jameshardiepros.com for additional cutting and dust control recommendations.

**IMPORTANT:** The Occupational Safety and Health Administration (OSHA) regulates workplace exposure to silica dust. For construction sites, OSHA has deemed that cutting fiber cement with a circular saw having a blade diameter less than 8 inches and connected to a commercially available dust collection system per manufacturer's instructions results in exposures below the OSHA Permissible Exposure Limit (PEL) for respirable crystalline silica, without the need for additional respiratory protection.

If you are unsure about how to comply with OSHA silica dust regulations, consult a qualified industrial hygienist or safety professional, or contact your James Hardie technical sales representative for assistance. James Hardie makes no representation or warranty that adopting a particular cutting practice will assure your compliance with OSHA rules or other applicable laws and safety requirements.

**HardieTrim® boards are decorative non-load bearing trim products.**

**Do not use HardieTrim boards to replace any structural component.**

**TABLE OF CONTENTS**

**GENERAL REQUIREMENTS** ..... Page 1

**FLASHING/CLEARANCE REQUIREMENTS** ..... Page 2

**FASTENING** ..... Page 3

    Face Nailing Requirements ..... Page 3

**INSTALLATION** ..... Page 4-8

    Trimming Corners ..... Page 4

    Openings ..... Page 4

    Band Boards ..... Page 4

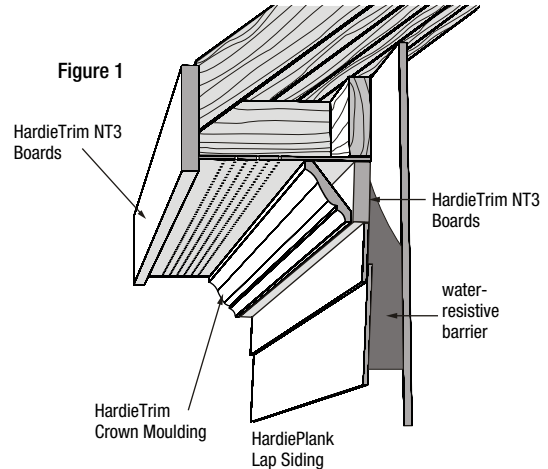
    Frieze ..... Page 4

    Batten Boards ..... Page 5

    Fascia ..... Page 6

    HardieTrim™ Tabs ..... Page 7-8

**FINISHING** ..... Page 9



**GENERAL REQUIREMENTS**

- Wood or steel must be provided for attaching HardieTrim boards.
- Follow all applicable codes when installing HardieTrim boards.
- DO NOT install HardieTrim boards, such that they may remain in contact with standing water.



## FLASHING/CLEARANCE REQUIREMENTS NO-COVER

HardieTrim may be installed with a minimum 1/4 in. clearance when installed vertically to grade, decks, paths, steps, and driveways

Maintain a minimum 2 in. horizontal clearance between James Hardie trim products and decks, paths, steps and driveways.

At the juncture of the roof and vertical surfaces, flashing and counter flashing shall be installed per the roofing manufacturer's instructions. Provide a 2 in. clearance between the roofing and the bottom edge of the trim.

Figure 2

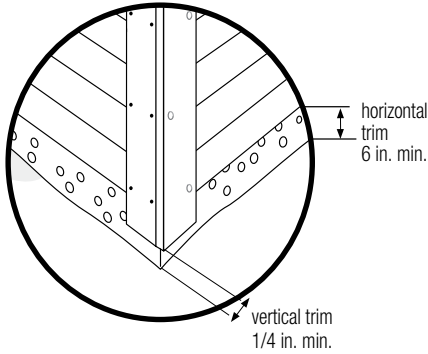


Figure 3

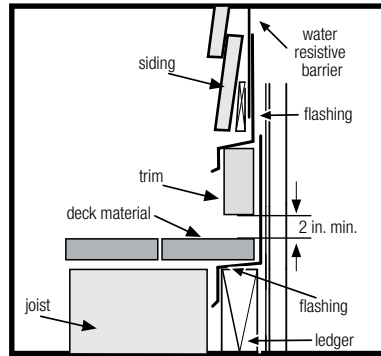
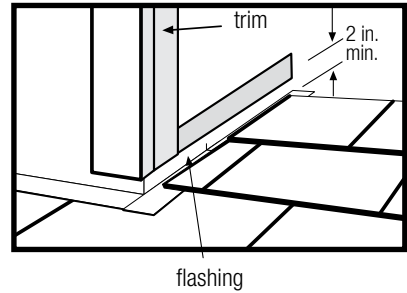


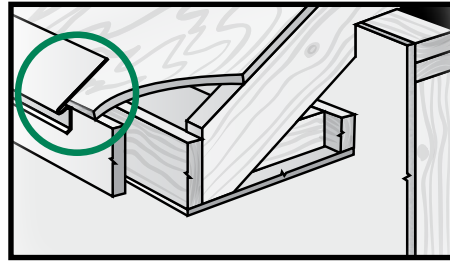
Figure 4



Maintain a 1/4 in. clearance between the bottom of James Hardie products and horizontal flashing. Do not caulk gap.

### Drip Edge

Figure 6 for fascia installation see page 6



### Mortar/Masonry

Figure 7

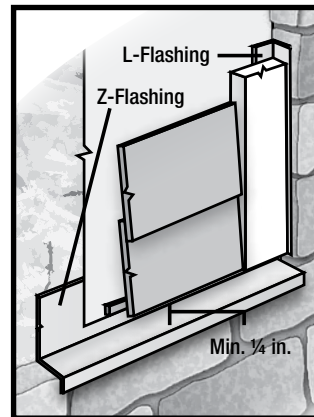
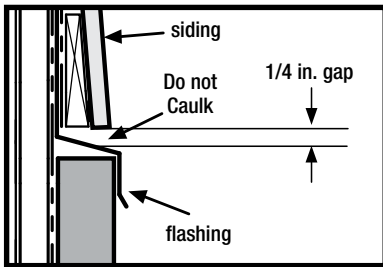
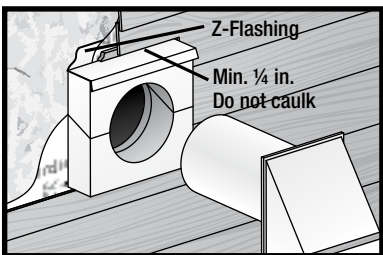


Figure 5



### Block Penetration Recommended in HZ10

Figure 8



### Valley/Shingle Extension

Figure 9

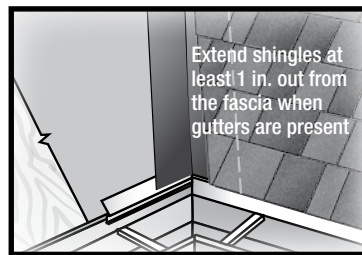
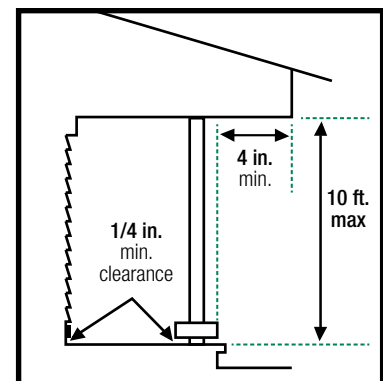


Figure 10



## CLEARANCE REQUIREMENTS UNDER-COVER

Maintain a 1/4 in. clearance for HardieTrim boards installed under cover. Under cover is defined as:

- Not more than 10 feet below a roof overhang, and
- Not less than 4 inches horizontally from the edge of the roof overhang



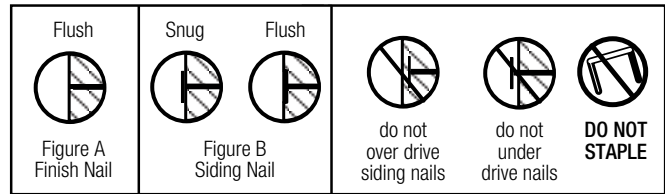
### GENERAL FASTENING REQUIREMENTS

Fasteners must be corrosion resistant, galvanized, or stainless steel. Electro-galvanized are acceptable but may exhibit premature corrosion. James Hardie recommends the use of quality, hot-dipped galvanized nails. James Hardie is not responsible for the corrosion resistance of fasteners. Stainless steel fasteners are recommended when installing James Hardie products near the ocean, large bodies of water, or in very humid climates.

Manufacturers of ACQ and CA preservative-treated wood recommend spacer materials or other physical barriers to prevent direct contact of ACQ or CA preservative-treated wood and aluminum products. Fasteners used to attach HardieTrim Tabs to preservative-treated wood shall be of hot dipped zinc-coated galvanized steel or stainless steel and in accordance to 2009 IRC R317.3 or 2009 IBC 2304.9.5.”

### PNEUMATIC FASTENING

James Hardie products can be hand nailed or fastened with a pneumatic tool. Pneumatic fastening is highly recommended. Set air pressure so that the fastener is driven snug with the surface of the trim. A flush mount attachment on the pneumatic tool is recommended. This will help control the depth the nail is driven. If setting the nail depth proves difficult, choose a setting that under drives the nail. (Drive under driven nails snug with a smooth faced hammer - Does not apply for installation to steel framing).



### FACE NAILING REQUIREMENTS

Use 2 in. minimum 16 ga. finish nails to attach HardieTrim boards to wood frame construction. ET&F or equivalent fasteners or screws may be used to attach HardieTrim boards to steel frame construction.

Fastening instructions are similar for all applications. When using finish nails, position nails no closer than 1/2 in. from the edges of the trim and for all other fasteners no closer than 3/4 in. Fasteners must be no closer than 1 in. from ends of trim and spaced a maximum of 16 in. O.C. Ensure trim is adequately fastened.

James Hardie recommends using stainless steel finish nails when installing HardieTrim products.

#### Minimum fastener guide for finish nailing:

	Pre-built corner	Site Built Corners	Other areas (e.g. window trim, and band boards)
4 in.	1 nail every 16 in. to attach boards together + 1 nail every 16 in. each board	2 nails every 16 in.	2 nails every 16 in.
6 in.	1 nail every 16 in. to attach boards together + 2 nails every 16 in. each board		
8 in.	-	3 nails every 16 in.	3 nails every 16 in.
12 in.	-	4 nails every 16 in.	3 nails every 16 in.

Use a 2 in. finish nail to fasten trim together. Longer finish nails may bend.

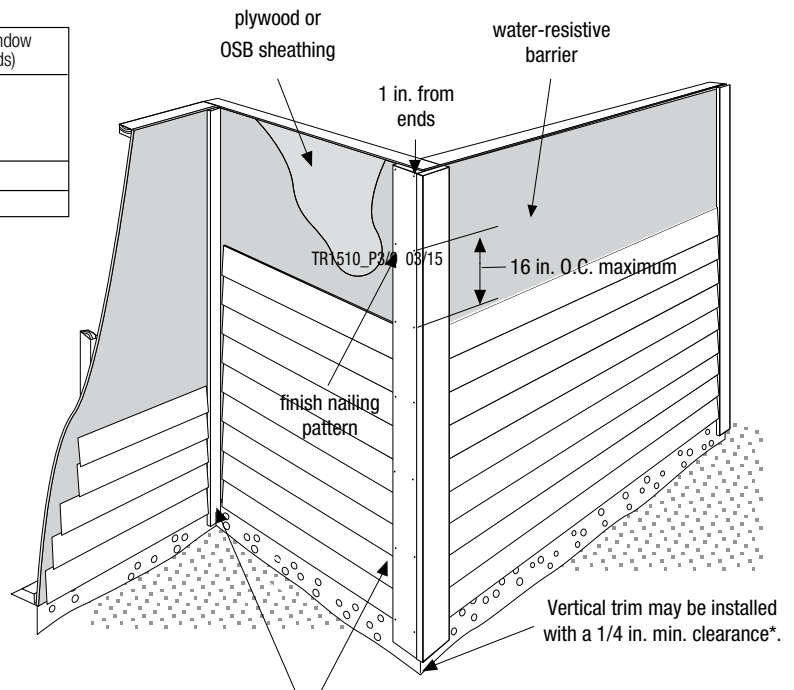


Figure 11

Leave a minimum 1/8 in. gap between the siding and trim, then caulk.

\*Follow all applicable codes when installing HardieTrim boards





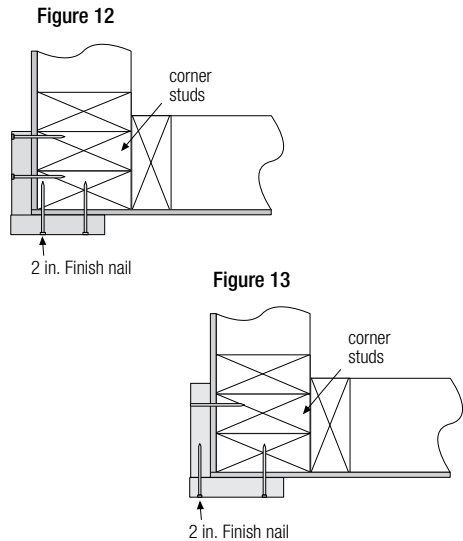
## INSTALLATION

### TRIMMING CORNERS

When installing corners or other vertical trim, position boards on the wall and attach (figure 12).

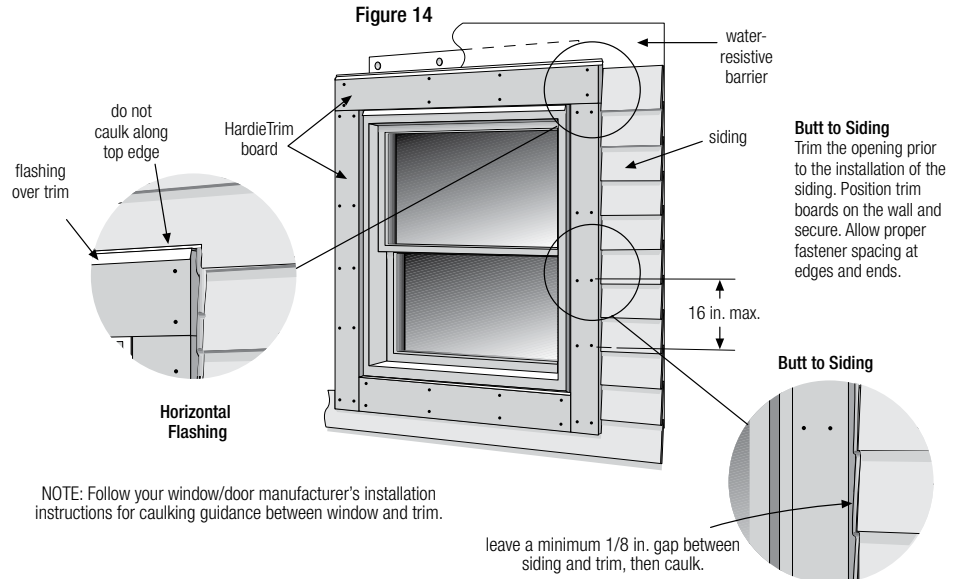
#### Pre-Built Corners

Alternatively, corners can be pre-built off the wall using 2 in. finishing nails. Each side of the pre-built corner must be secured to the wall (figure 13).



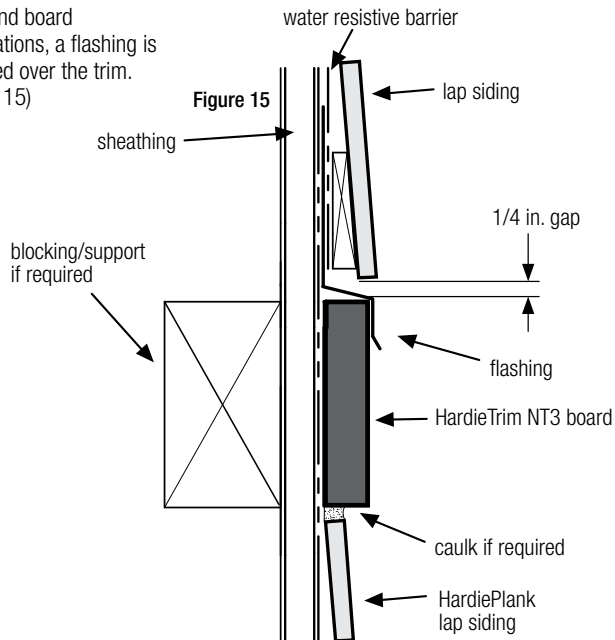
### TRIM APPLICATION FOR WINDOWS, DOORS & OTHER OPENINGS

Flashing over trim is required per code for all installation methods. (figure 14)



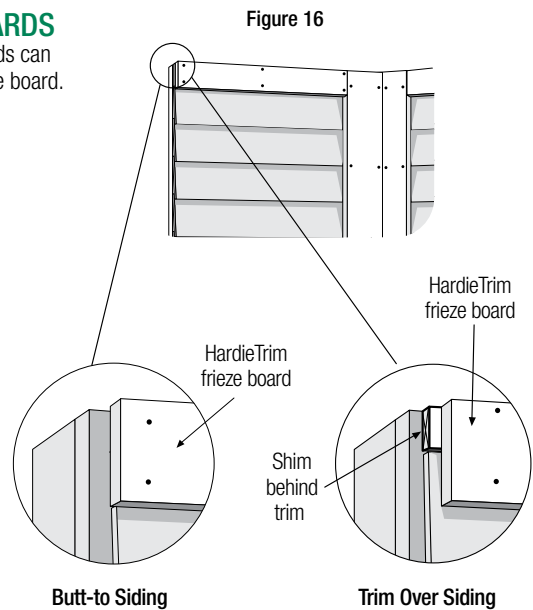
### BAND BOARD

For band board applications, a flashing is required over the trim. (figure 15)



### FRIEZE BOARDS

HardieTrim boards can be used as frieze board. (figure 16)



## BATTEN BOARDS

### HORIZONTAL PANEL JOINTS

At horizontal panel joints HardieTrim battens must be installed according to option 1 or 2 below. When installing HardieTrim Battens horizontally, they must be installed as a panel joint according to option 2.

#### Option 1

Figure 17 - No horizontal band board - Make a 22.5 - 45 degree weather cut, in the HardieTrim batten, just above the 1/4 in. clearance between panels.

#### Option 2

Figure 18 - Horizontal Band Board - Install a horizontal band board at the top of the bottom panel. Butt the lower batten to the band board and start the top batten at the bottom edge of the top panel. Maintain a 1/4 in. clearance above horizontal flashing.

Figure 17

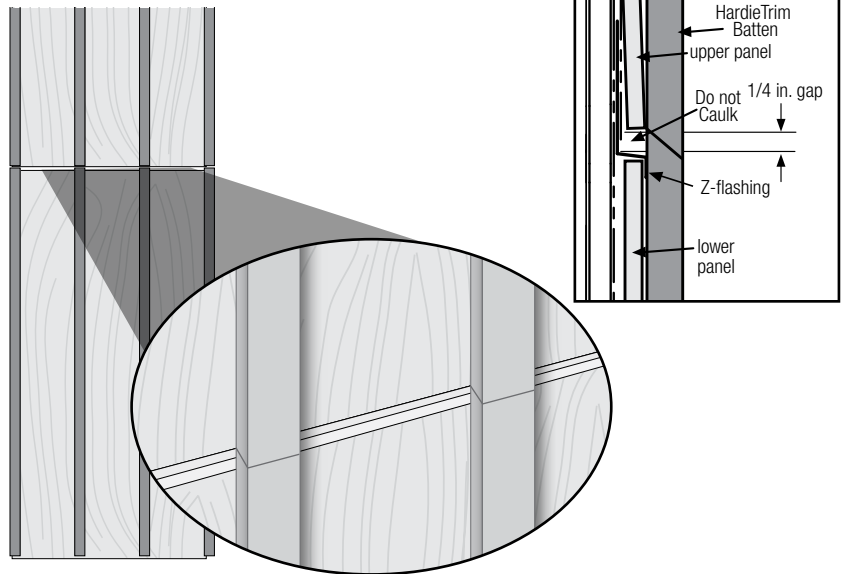
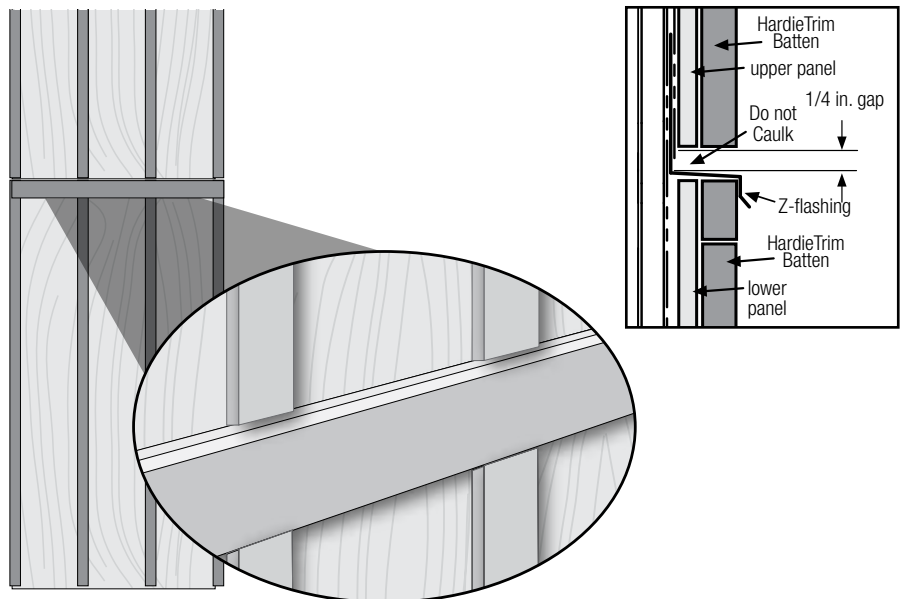


Figure 18



## FASCIA

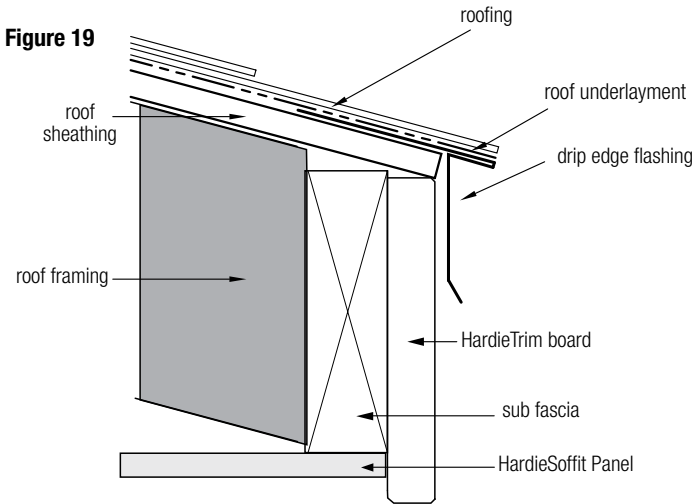
Do not use HardieTrim to replace any structural component

HardieTrim boards can be fastened directly over a 2x sub-fascia or directly to rafter tails. Check local building code for relevant codes.

### Option 1

**Over sub-fascia:** (figure 19)

When installing HardieTrim boards over solid 2x sub-fascia use minimum 2 in., 16 gauge corrosion resistant finish nails. (see fastener guide below)



### Gutters:

James Hardie recommends the use of rain gutters whenever possible.

#### Do not attach gutters directly to HardieTrim

Use gutter hangers that attach through the roof sheathing into a rafter tail or other structural member.

### Soffit

When installing HardieSoffit additional framing/blocking may be needed depending on application. Refer to HardieSoffit installation instructions for guidance.

### Option 2

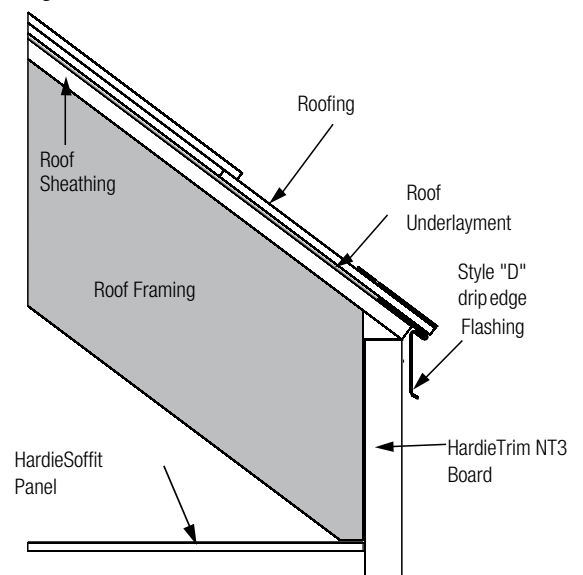
**Direct to rafter tails:** (figure 20)

When installing HardieTrim NT3 boards without the presence of a 2x sub-fascia, a minimum 8d siding corrosion resistant nails must be used to attach HardieTrim NT3 boards DO NOT use finish nails. (refer to fastener guide below).

## Fascia Fastener Guide

HardieTrim Board	FASTENER SPACING	
	Direct to Rafter (min 8d siding)	Over 2x Sub-fascia (Minimum 2 in. 16 ga. Finish nails)
6 in.	2 nails every rafter spaced max 24 in. O.C.	2 nails spaced maximum 16 in. O.C.
8 in.	3 nails every rafter spaced max 24 in. O.C.	3 nails spaced maximum 16 in. O.C.
10 in.		4 nails spaced maximum 16 in. O.C.

Figure 20



## HARDIETRIM® TABS

### FASTENER REQUIREMENTS

#### For Corners, Band Boards, Windows, and Door Applications:

HardieTrim NT3 boards may be installed with HardieTrim™ Flat Tabs and HardieTrim™ Corner Tabs which provide concealed fastening. Only HardieTrim Flat and Corner Tabs can be used with HardieTrim NT3 boards to create a concealed fastening.

**Step 1:** Attach HardieTrim Flat Tabs to the back side of the trim using four, 18 ga. 1/2 in. L x 1/4 in. W narrow crown corrosion resistant staples, equally spaced in one row, positioned no closer than 1/2 in. from trim edges using a pneumatic staple gun. (figures 21, 22)

**Step 2:** For wood frame construction, attach the trim to the building with minimum 2, 6d siding nails fastened through the HardieTrim Flat Tabs (figure 23). ET&F or equivalent fasteners may be used to attach the HardieTrim Flat Tabs to steel frame construction.

Fastener spacing will vary based on application. Refer to fastener table on page 9. Refer to specific sections in these instructions for required fastener spacing by application (window, band board, etc.)

#### For Fascia, Rake, and Frieze board Applications:

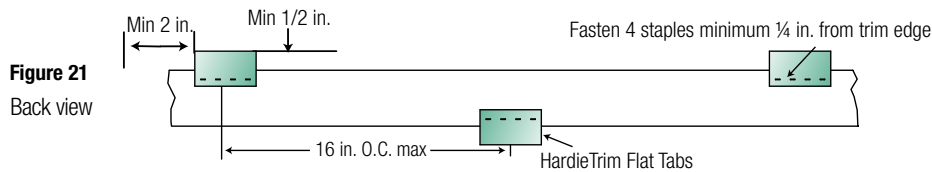
HardieTrim tabs cannot be used in fascia, rake, or frieze board applications. Follow Face nailing fastening specifications.

#### Installation of HardieTrim tabs in Coastal Regions:

James Hardie requires that stainless steel staples & fasteners be used when installing HardieTrim Tabs in coastal regions.

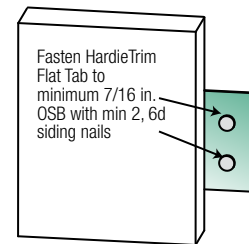
**Installation of HardieTrim Tabs over Pressure Treated Lumber: HardieTrim tabs shall not** come in direct contact with ACQ or CA preservative-treated wood. Refer to the General Fastening section of this document for further information.

**HardieTrim boards with ColorPlus Technology:** Remove the laminate sheet as soon as possible after attaching the trim to the building.



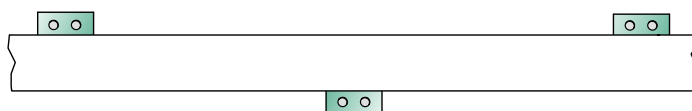
**Figure 21**  
Back view

**Figure 23**

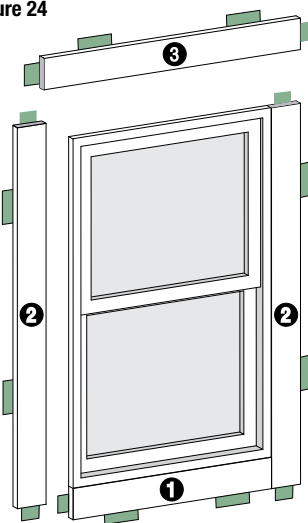


Fasten HardieTrim Flat Tab to minimum 7/16 in. OSB with min 2, 6d siding nails

**Figure 22**  
Front view

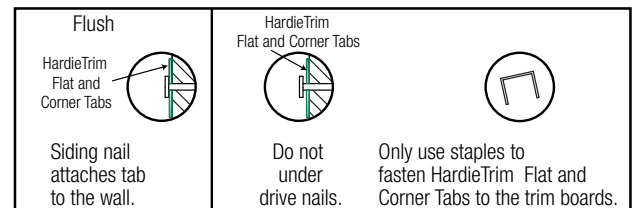


**Figure 24**



#### Trim Application for Windows, Doors & Other Openings

Trim the opening prior to the installation of the siding. Place a Flat Tab at the end of each trim board and one tab every 16 in. OC. Attach the trim boards and Flat Tabs around the opening as shown in figure 24. Use 16 ga. galvanized 2 in. long finish nails to ensure proper fastening if needed.



NOTE: Follow your window/door manufacturers installation instructions for caulking guidance between window and trim.

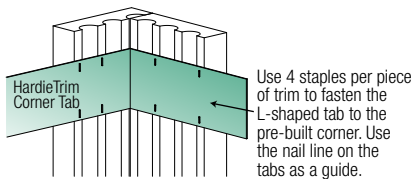


## TRIMMING CORNERS

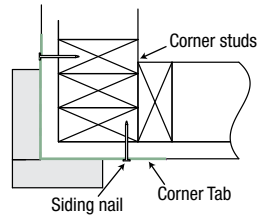
When using HardieTrim tabs prebuild outside corners off the wall.

- Attach HardieTrim Corner Tabs to the back side of the trim using eight(8) - 18 ga. 1/2 in. L x 1/4 in. W narrow crown corrosion resistant staples using a pneumatic stapler. Ensure the HardieTrim Corner Tabs are fastened tight and straight to the trim boards. (figure 25)
- For wood frame construction, attach trim to building using min. 6d siding nails fastened through the HardieTrim Corner Tabs attached to minimum 7/16 in. OSB \*. (figure 26)
- Attach a HardieTrim Corner Tab 1 in. from each ends and every 20 in. O.C.
- TIP: Creating a jig for the work station is recommended to ensure corners are fastened securely and straight. (figure 27)

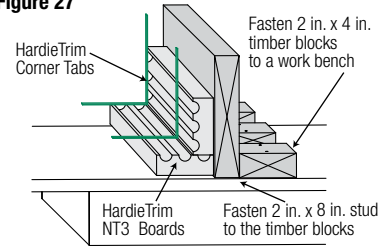
**Figure 25**



**Figure 26**



**Figure 27**



## BAND BOARD

Terminate ends of the Band Board into Trim or Siding or miter cut the edges of the trim at the corners of the building. Place a HardieTrim Flat Tab at the end of each trim board and one tab every stud at a maximum of 16 in. O.C. The HardieTrim Flat Tabs should be attached to the trim in an alternating pattern to the top and bottom of the band board (figures 21, 22). Use 16 ga. galvanized 2 in. long finish nails to ensure proper fastening if needed.

**Trim Tab Fastener Table**

Application	Framing Material Tab is nailed into	Fastener (tab to framing)	Fastener (tab to trim)	Max Tab Spacing (inches on center)
Flat Tab	Wood Stud (minimum G=0.42)	One 6d corrosion resistant siding nail installed through center of tab into framing	Four 18 ga. X 1/2 in. long X 1/4 in. wide corrosion resistant crown staples, equally spaced in one row	16
	Minimum APA rated 7/16 in. OSB	Two 4d ring shank corrosion resistant siding nails equally spaced installed through tab into framing		
	Minimum 20 gauge steel	One No. 8 X 1 in. long X 0.323 in. head diameter screw (corrosion resistant) installed through flange into framing		
Corner Tab	Wood Stud (minimum G=0.42)	On each flange, install one 6d corrosion resistant siding nail through tab into framing	For each piece of trim, install Four 18 ga. X 1/2 in. long X 1/4 in. wide corrosion resistant crown staples, equally space in two rows	20
	Minimum APA rated 7/16 in. OSB	On each flange, install two 4d ring shank corrosion resistant siding nails through tab into framing		
	Minimum 20 gauge steel	On each flange, install one No. 8 X 1 in. long X 0.323 in. head diameter screw (corrosion resistant) through tab into framing		







## FINISHING

### CUT EDGE TREATMENT

Caulk, paint or prime all field cut edges. James Hardie touch-up kits are required to touch-up ColorPlus products.

### CAULKING

For best results use an Elastomeric Joint Sealant complying with ASTM C920 Grade NS, Class 25 or higher or a Latex Joint Sealant complying with ASTM C834. Caulking/Sealant must be applied in accordance with the caulking/sealant manufacturer's written instructions.

### PAINTING

DO NOT use stain, oil/alkyd base paint, or powder coating on James Hardie Products. James Hardie products must be painted within 180 days for primed product and 90 days for unprimed. 100% acrylic topcoats are recommended. Do not paint when wet. For application rates refer to paint manufacturers specifications. Back-rolling is recommended if the siding is sprayed.

### COLORPLUS TECHNOLOGY CAULKING, TOUCH-UP & LAMINATE

- Care should be taken when handling and cutting James Hardie® ColorPlus® products. During installation use a wet soft cloth or soft brush to gently wipe off any residue or construction dust left on the product, then rinse with a garden hose.
- Touch up nicks, scrapes and nail heads using the ColorPlus® Technology touch-up applicator. Touch-up should be used sparingly. If large areas require touch-up, replace the damaged area with new HardiePlank® lap siding with ColorPlus® Technology.
- Laminate sheet must be removed immediately after installation of each course.
- Terminate non-factory cut edges into trim where possible, and caulk. Color matched caulks are available from your ColorPlus® product dealer.
- Treat all other non-factory cut edges using the ColorPlus Technology edge coat, available from your ColorPlus product dealer.

**Note:** James Hardie does not warrant the usage of third party touch-up or paints used as touch-up on James Hardie ColorPlus products.

Problems with appearance or performance arising from use of third party touch-up paints or paints used as touch-up that are not James Hardie touch-up will not be covered under the James Hardie ColorPlus Limited Finish Warranty.

### PAINTING JAMES HARDIE SIDING AND TRIM PRODUCTS WITH COLORPLUS TECHNOLOGY

When repainting ColorPlus products, James Hardie recommends the following regarding surface preparation and topcoat application:

- Ensure the surface is clean, dry, and free of any dust, dirt, or mildew
- Repriming is normally not necessary
- 100% acrylic topcoats are recommended
- DO NOT use stain, oil/alkyd base paint, or powder coating on James Hardie® Products.
- Apply finish coat in accordance with paint manufacturers written instructions regarding coverage, application methods, and application temperature
- DO NOT caulk nail heads when using ColorPlus products, refer to the ColorPlus touch-up section

TR1510\_P9/9 09/19

#### SILICA WARNING

**DANGER:** May cause cancer if dust from product is inhaled. Causes damage to lungs and respiratory system through prolonged or repeated inhalation of dust from product. Refer to the current product Safety Data Sheet before use. The hazard associated with fiber cement arises from crystalline silica present in the dust generated by activities such as cutting, machining, drilling, routing, sawing, crushing, or otherwise abrading fiber cement, and when cleaning up, disposing of or moving the dust. When doing any of these activities in a manner that generates dust you must (1) comply with the OSHA standard for silica dust and/or other applicable law, (2) follow James Hardie cutting instructions to reduce or limit the release of dust; (3) warn others in the area to avoid breathing the dust; (4) when using mechanical saw or high speed cutting tools, work outdoors and use dust collection equipment; and (5) if no other dust controls are available, wear a dust mask or respirator that meets NIOSH requirements (e.g. N-95 dust mask). During clean-up, use a well maintained vacuum and filter appropriate for capturing fine (respirable) dust or use wet clean-up methods - never dry sweep.

**WARNING:** This product can expose you to chemicals including respirable crystalline silica, which is known to the State of California to cause cancer. For more information go to [P65Warnings.ca.gov](http://P65Warnings.ca.gov).

**RECOGNITION:** HardieTrim boards may be installed as an equal alternative to conventional trim permitted for use in; 2006, 2009, 2012 & 2015 International Building Code, Section 1403, and the 2006, 2009, 2012 & 2015 International Residential Code for One and Two-Family Dwellings, Section R703.

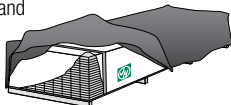


These instructions are to be used for HardieTrim® HZ™ Boards ONLY and are **ONLY VALID** in the following states: WA, OR, CA, NV, UT, ID, CO, WY, MT, AZ, NM.

**IMPORTANT: FAILURE TO FOLLOW JAMES HARDIE WRITTEN INSTALLATION INSTRUCTIONS AND COMPLY WITH APPLICABLE BUILDING CODES MAY VIOLATE LOCAL LAWS, AFFECT BUILDING ENVELOPE PERFORMANCE AND MAY AFFECT WARRANTY COVERAGE. FAILURE TO COMPLY WITH ALL HEALTH AND SAFETY REGULATIONS WHEN CUTTING AND INSTALLING THIS PRODUCT MAY RESULT IN PERSONAL INJURY. BEFORE INSTALLATION, CONFIRM YOU ARE USING THE CORRECT HARDIEZONE® PRODUCT INSTRUCTIONS BY VISITING HARDIEZONE.COM OR CALL 1-866-942-7343 (866-9-HARDIE)**

**STORAGE & HANDLING:**

Store flat and keep dry and covered prior to installation. Installing siding wet or saturated may result in shrinkage at butt joints. Carry planks on edge. Protect edges and corners from breakage. James Hardie is not responsible for damage caused by improper storage and handling of the product.



**CUTTING INSTRUCTIONS**

**OUTDOORS**

1. Position cutting station so that airflow blows dust away from the user and others near the cutting area.
2. Cut using one of the following methods:
  - a. Best: Circular saw equipped with a HardieBlade® saw blade and attached vacuum dust collection system. Shears (manual, pneumatic or electric) may also be used, not recommended for products thicker than 7/16 in.
  - b. Better: Circular saw equipped with a dust collection feature (e.g. Roan® saw) and a HardieBlade saw blade.
  - c. Good: Circular saw equipped with a HardieBlade saw blade.

**INDOORS**

- DO NOT grind or cut with a power saw indoors. Cut using shears (manual, pneumatic or electric) or the score and snap method, not recommended for products thicker than 7/16 in.
- DO NOT dry sweep dust; use wet dust suppression or vacuum to collect dust.
  - For maximum dust reduction, James Hardie recommends using the "Best" cutting practices. Always follow the equipment manufacturer's instructions for proper operation.
  - For best performance when cutting with a circular saw, James Hardie recommends using HardieBlade® saw blades.
  - Go to jameshardiepros.com for additional cutting and dust control recommendations.

**IMPORTANT:** The Occupational Safety and Health Administration (OSHA) regulates workplace exposure to silica dust. For construction sites, OSHA has deemed that cutting fiber cement with a circular saw having a blade diameter less than 8 inches and connected to a commercially available dust collection system per manufacturer's instructions results in exposures below the OSHA Permissible Exposure Limit (PEL) for respirable crystalline silica, without the need for additional respiratory protection.

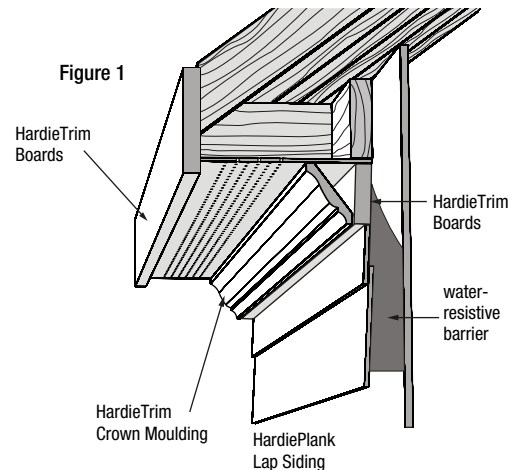
If you are unsure about how to comply with OSHA silica dust regulations, consult a qualified industrial hygienist or safety professional, or contact your James Hardie technical sales representative for assistance. James Hardie makes no representation or warranty that adopting a particular cutting practice will assure your compliance with OSHA rules or other applicable laws and safety requirements.

**HardieTrim® boards are decorative non-load bearing trim products.**

**Do not use HardieTrim boards to replace any structural component.**

**TABLE OF CONTENTS**

<b>GENERAL REQUIREMENTS</b> .....	<b>Page 1</b>
<b>FLASHING/CLEARANCE REQUIREMENTS</b> .....	<b>Page 2</b>
<b>FASTENING</b> .....	<b>Page 3</b>
Face Nailing Requirements .....	Page 3
<b>INSTALLATION</b> .....	<b>Page 4-8</b>
Trimming Corners .....	Page 4
Openings .....	Page 4
Band Boards .....	Page 4
Frieze .....	Page 4
Batten Boards .....	Page 5
Fascia .....	Page 6
HardieTrim™ Tabs .....	Page 7-8
<b>FINISHING</b> .....	<b>Page 9</b>



**GENERAL REQUIREMENTS**

- Wood or steel must be provided for attaching HardieTrim boards.
- Follow all applicable codes when installing HardieTrim boards.
- DO NOT install HardieTrim boards, such that they may remain in contact with standing water.
- DO NOT use stain, oil/alkyd base paint, or powder coating on James Hardie Products.





## FLASHING/CLEARANCE REQUIREMENTS NO-COVER

HardieTrim may be installed with a minimum 1/4 in. clearance when installed vertically to grade, decks, paths, steps, and driveways

Maintain a minimum 1 in. horizontal clearance between James Hardie trim products and decks, paths, steps and driveways.

At the juncture of the roof and vertical surfaces, flashing and counter flashing shall be installed per the roofing manufacturer's instructions. Provide a 1 in. clearance between the roofing and the bottom edge of the trim.

Figure 2

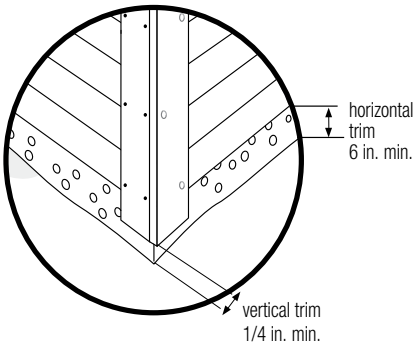


Figure 3

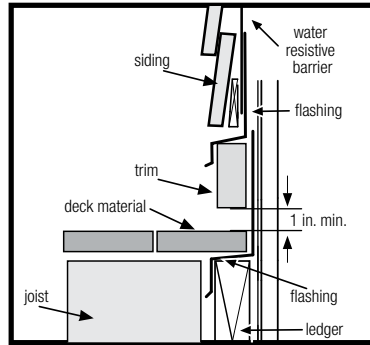
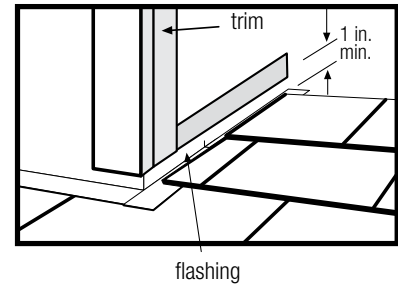
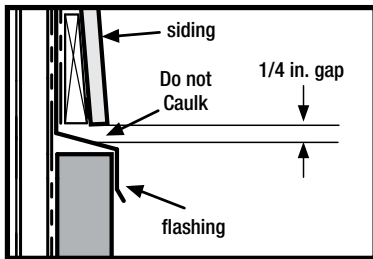


Figure 4



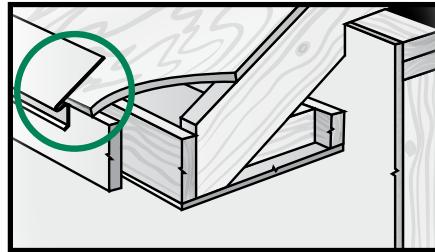
Maintain a 1/4 in. clearance between the bottom of James Hardie products and horizontal flashing. Do not caulk gap.

Figure 5



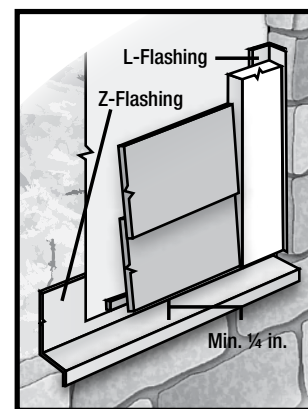
### Drip Edge

Figure 6 for fascia installation see page 6



### Mortar/Masonry

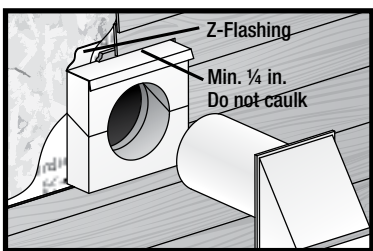
Figure 7



### Block Penetration

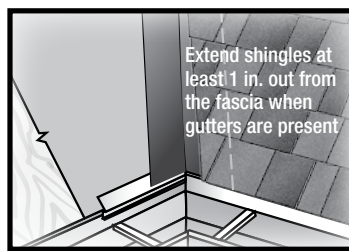
(recommended in HZ10)

Figure 8



### Valley/Shingle Extension

Figure 9

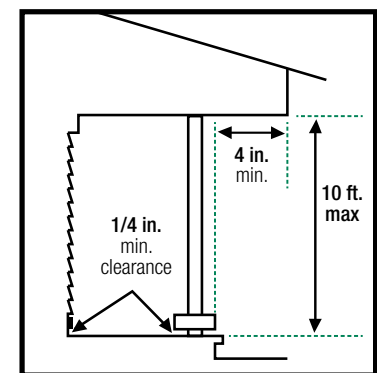


## CLEARANCE REQUIREMENTS UNDER-COVER

Maintain a 1/4 in. clearance for HardieTrim boards installed under cover. Under cover is defined as:

- Not more than 10 feet below a roof overhang, and
- Not less than 4 inches horizontally from the edge of the roof overhang

Figure 10





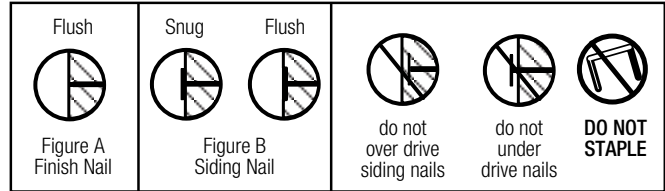
### GENERAL FASTENING REQUIREMENTS

Fasteners must be corrosion resistant, galvanized, or stainless steel. Electro-galvanized are acceptable but may exhibit premature corrosion. James Hardie recommends the use of quality, hot-dipped galvanized nails. James Hardie is not responsible for the corrosion resistance of fasteners. Stainless steel fasteners are recommended when installing James Hardie products near the ocean, large bodies of water, or in very humid climates.

Manufacturers of ACQ and CA preservative-treated wood recommend spacer materials or other physical barriers to prevent direct contact of ACQ or CA preservative-treated wood and aluminum products. Fasteners used to attach HardieTrim Tabs to preservative-treated wood shall be of hot dipped zinc-coated galvanized steel or stainless steel and in accordance to 2009 IRC R317.3 or 2009 IBC 2304.9.5.”

### PNEUMATIC FASTENING

James Hardie products can be hand nailed or fastened with a pneumatic tool. Pneumatic fastening is highly recommended. Set air pressure so that the fastener is driven snug with the surface of the trim. A flush mount attachment on the pneumatic tool is recommended. This will help control the depth the nail is driven. If setting the nail depth proves difficult, choose a setting that under drives the nail. (Drive under driven nails snug with a smooth faced hammer - Does not apply for installation to steel framing).



### FACE NAILING REQUIREMENTS

Use 2 in. minimum 16 ga. finish nails to attach HardieTrim boards to wood frame construction. ET&F or equivalent fasteners or screws may be used to attach HardieTrim boards to steel frame construction.

Fastening instructions are similar for all applications. When using finish nails, position nails no closer than 1/2 in. from the edges of the trim and for all other fasteners no closer than 3/4 in. Fasteners must be no closer than 1 in. from ends of trim and spaced a maximum of 16 in. O.C. Ensure trim is adequately fastened.

James Hardie recommends using stainless steel finish nails when installing HardieTrim products.

#### Minimum fastener guide for finish nailing:

	Pre-built corner	Site Built Corners	Other areas (e.g. window trim, and band boards)
4 in.	1 nail every 16 in. to attach boards together + 1 nail every 16 in. each board	2 nails every 16 in.	2 nails every 16 in.
6 in.	1 nail every 16 in. to attach boards together + 2 nails every 16 in. each board		
8 in.	-	3 nails every 16 in.	3 nails every 16 in.
12 in.	-	4 nails every 16 in.	3 nails every 16 in.

Use a 2 in. finish nail to fasten trim together. Longer finish nails may bend.

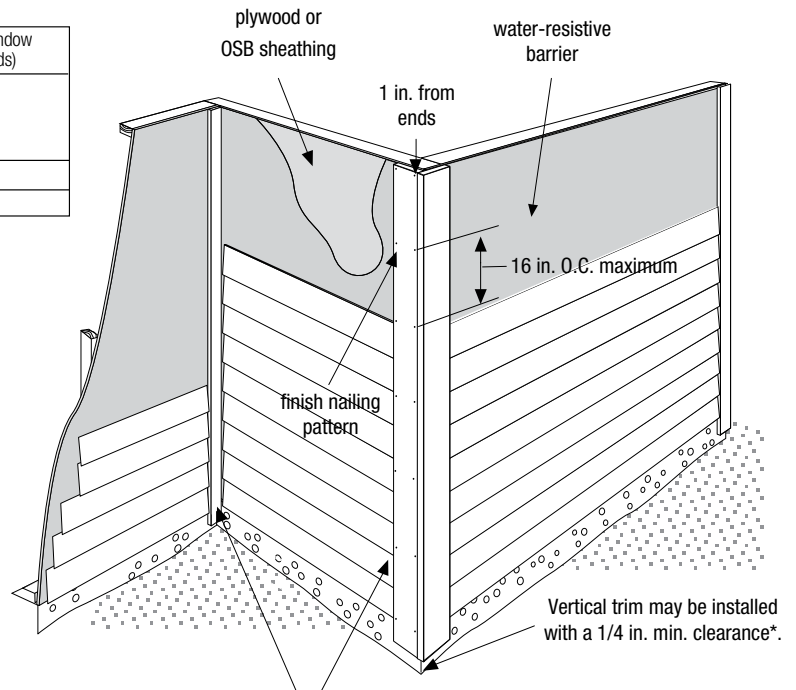


Figure 11

\*Follow all applicable codes when installing HardieTrim boards





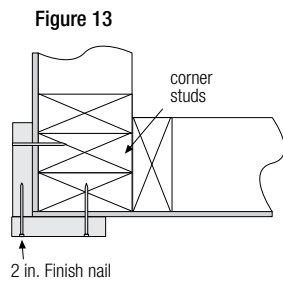
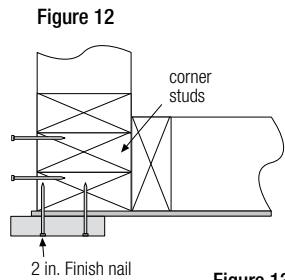
## INSTALLATION

### TRIMMING CORNERS

When installing corners or other vertical trim, position boards on the wall and attach (figure 12).

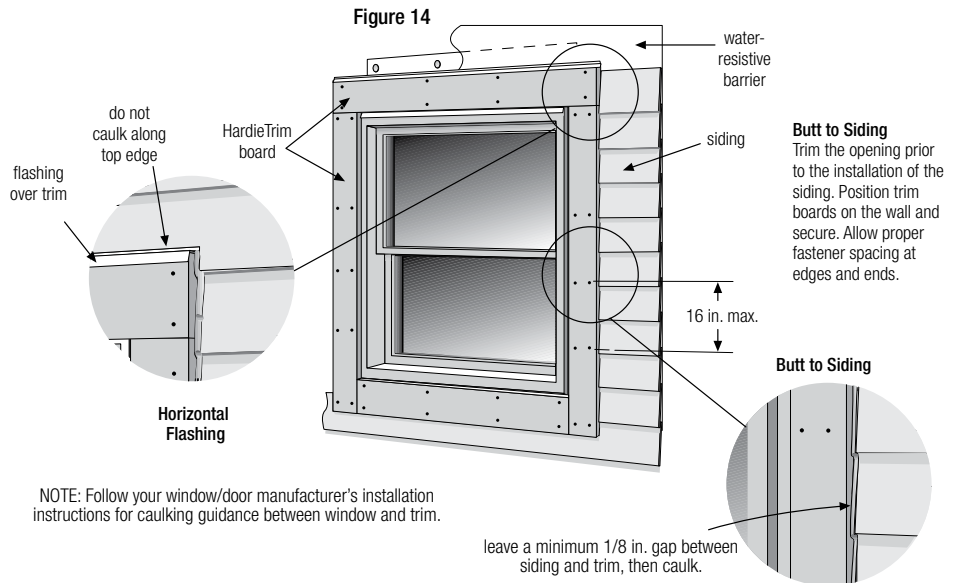
#### Pre-Built Corners

Alternatively, corners can be pre-built off the wall using 2 in. finishing nails. Each side of the pre-built corner must be secured to the wall (figure 13).



### TRIM APPLICATION FOR WINDOWS, DOORS & OTHER OPENINGS

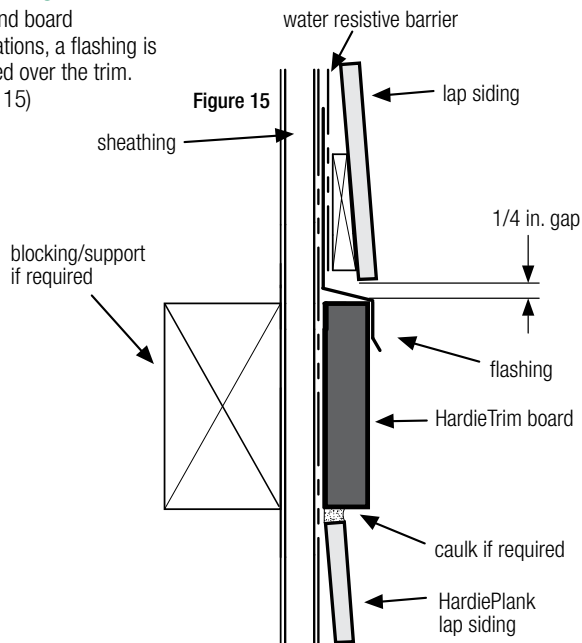
Flashing over trim is required per code for all installation methods. (figure 14)



NOTE: Follow your window/door manufacturer's installation instructions for caulking guidance between window and trim.

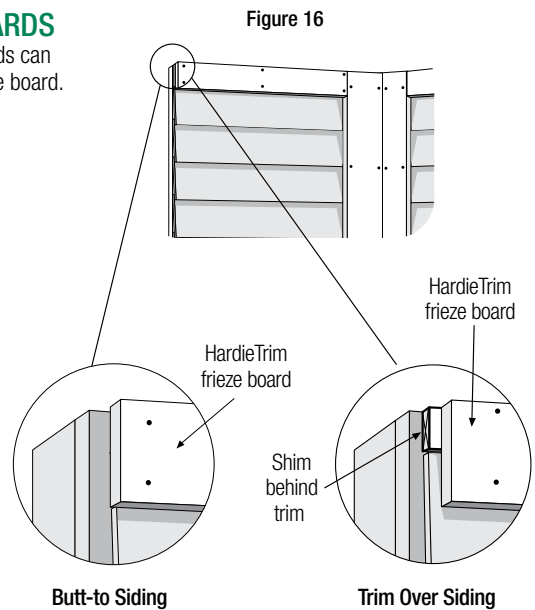
### BAND BOARD

For band board applications, a flashing is required over the trim. (figure 15)



### FRIEZE BOARDS

HardieTrim boards can be used as frieze board. (figure 16)







## BATTEN BOARDS

### HORIZONTAL PANEL JOINTS

At horizontal panel joints HardieTrim battens must be installed according to option 1 or 2 below. When installing HardieTrim Battens horizontally, they must be installed as a panel joint according to option 2.

#### Option 1

Figure 17 - No horizontal band board - Make a 22.5 - 45 degree weather cut, in the HardieTrim batten, just above the 1/4 in. clearance between panels.

#### Option 2

Figure 18 - Horizontal Band Board - Install a horizontal band board at the top of the bottom panel. Butt the lower batten to the band board and start the top batten at the bottom edge of the top panel. Maintain a 1/4 in. clearance above horizontal flashing.

Figure 17

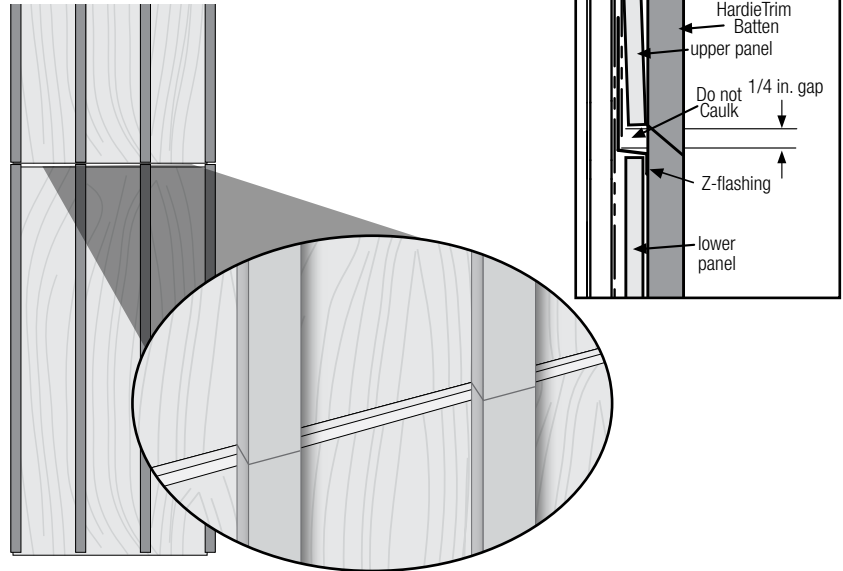
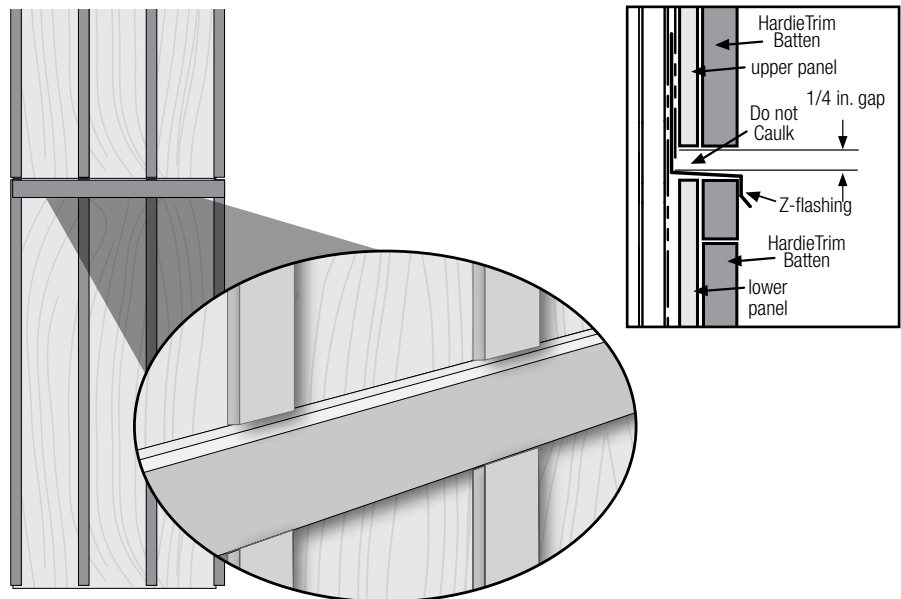


Figure 18





## FASCIA

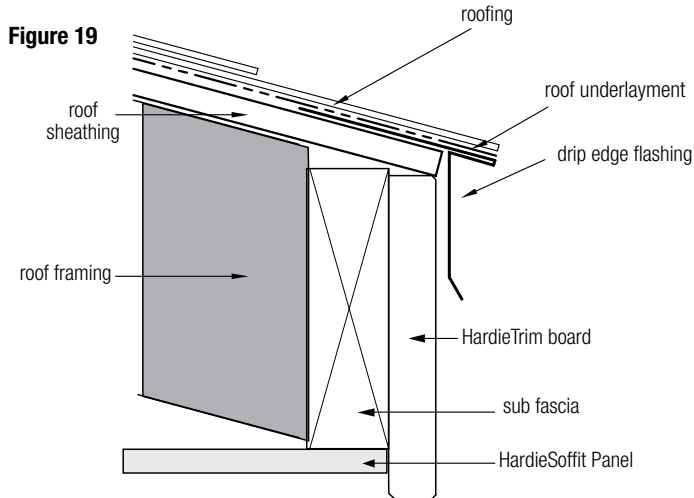
HardieTrim board is a decorative non-load bearing trim product. Do not use HardieTrim to replace any structural component.

HardieTrim boards can be fastened directly over a 2x sub-fascia or directly to rafter tails. Check local building code for relevant codes.

### Option 1

**Over sub-fascia:** (figure 19)

When installing HardieTrim boards over solid 2x sub-fascia use minimum 2 in., 16 gauge corrosion resistant finish nails. (see fastener guide below)



### Gutters:

James Hardie recommends the use of rain gutters whenever possible.

#### Do not attach gutters directly to HardieTrim

Use gutter hangers that attach through the roof sheathing into a rafter tail or other structural member.

### Soffit

When installing HardieSoffit additional framing/blocking may be needed depending on application. Refer to HardieSoffit installation instructions for guidance.

### Option 2

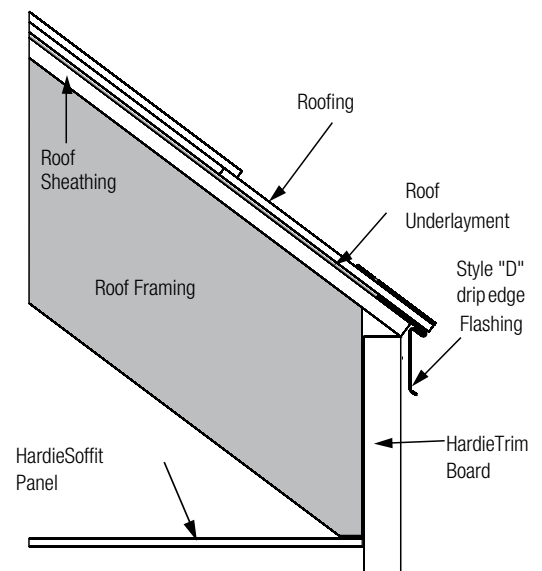
**Direct to rafter tails:** (figure 20)

When installing HardieTrim boards without the presence of a 2x sub-fascia, a minimum 8d siding corrosion resistant nails must be used to attach HardieTrim boards DO NOT use finish nails. (refer to fastener guide below).

## Fascia Fastener Guide

HardieTrim Board	FASTENER SPACING	
	Direct to Rafter (min 8d siding)	Over 2x Sub-fascia (Minimum 2 in. 16 ga. Finish nails)
6 in.	2 nails every rafter spaced max 24 in. O.C.	2 nails spaced maximum 16 in. O.C.
8 in.	3 nails every rafter spaced max 24 in. O.C.	3 nails spaced maximum 16 in. O.C.
10 in.		4 nails spaced maximum 16 in. O.C.

Figure 20





## HARDIETRIM® TABS

### FASTENER REQUIREMENTS

#### For Corners, Band Boards, Windows, and Door Applications:

HardieTrim boards may be installed with HardieTrim™ Flat Tabs and HardieTrim™ Corner Tabs which provide concealed fastening. Only HardieTrim Flat and Corner Tabs can be used with HardieTrim boards to create a concealed fastening.

**Step 1:** Attach HardieTrim Flat Tabs to the back side of the trim using four, 18 ga. 1/2 in. L x 1/4 in. W narrow crown corrosion resistant staples, equally spaced in one row, positioned no closer than 1/2 in. from trim edges using a pneumatic staple gun. (figures 21, 22)

**Step 2:** For wood frame construction, attach the trim to the building with minimum 2, 6d siding nails fastened through the HardieTrim Flat Tabs (figure 23). ET&F or equivalent fasteners may be used to attach the HardieTrim Flat Tabs to steel frame construction.

Fastener spacing will vary based on application. Refer to fastener table on page 9. Refer to specific sections in these instructions for required fastener spacing by application (window, band board, etc.)

#### For Fascia, Rake, and Frieze board Applications:

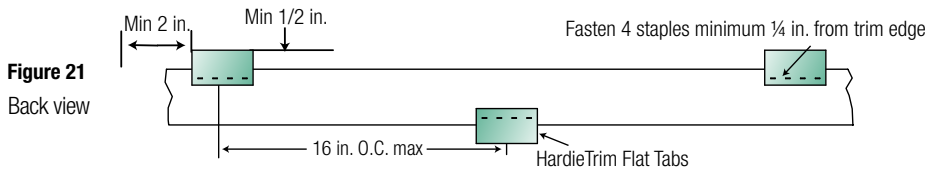
HardieTrim tabs cannot be used in fascia, rake, or frieze board applications. Follow Face nailing fastening specifications.

#### Installation of HardieTrim tabs in Coastal Regions:

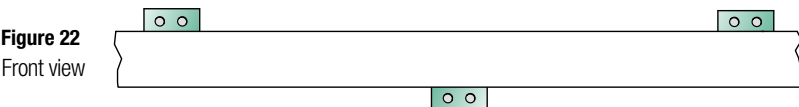
James Hardie requires that stainless steel staples & fasteners be used when installing HardieTrim Tabs in coastal regions.

**Installation of HardieTrim Tabs over Pressure Treated Lumber:** HardieTrim tabs **shall not** come in direct contact with ACQ or CA preservative-treated wood. Refer to the General Fastening section of this document for further information.

**HardieTrim boards with ColorPlus Technology:** Remove the laminate sheet as soon as possible after attaching the trim to the building.

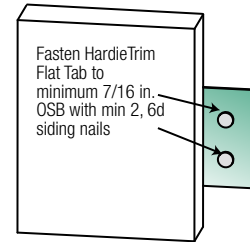


**Figure 21**  
Back view

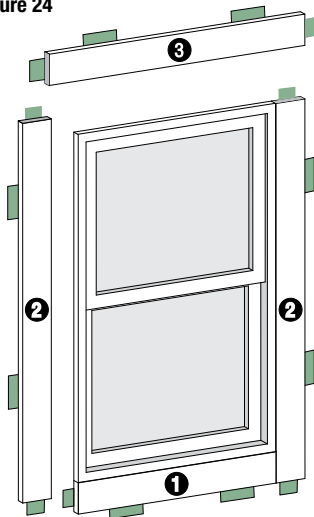


**Figure 22**  
Front view

**Figure 23**

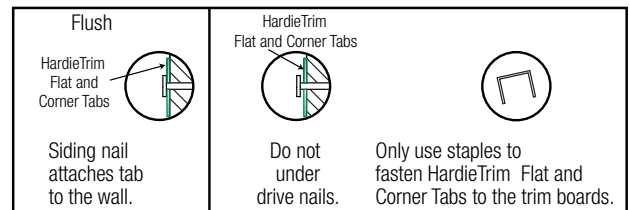


**Figure 24**



#### Trim Application for Windows, Doors & Other Openings

Trim the opening prior to the installation of the siding. Place a Flat Tab at the end of each trim board and one tab every 16 in. OC. Attach the trim boards and Flat Tabs around the opening as shown in figure 24. Use 16 ga. galvanized 2 in. long finish nails to ensure proper fastening if needed.



NOTE: Follow your window/door manufacturers installation instructions for caulking guidance between window and trim.





## TRIMMING CORNERS

When using HardieTrim tabs prebuild outside corners off the wall.

- Attach HardieTrim Corner Tabs to the back side of the trim using eight(8) - 18 ga. 1/2 in. L x 1/4 in. W narrow crown corrosion resistant staples using a pneumatic stapler. Ensure the HardieTrim Corner Tabs are fastened tight and straight to the trim boards. (figure 25)
- For wood frame construction, attach trim to building using min. 6d siding nails fastened through the HardieTrim Corner Tabs attached to minimum 7/16 in. OSB \*. (figure 26)
- Attach a HardieTrim Corner Tab 1 in. from each ends and every 20 in. O.C.
- TIP: Creating a jig for the work station is recommended to ensure corners are fastened securely and straight. (figure 27)

Figure 25

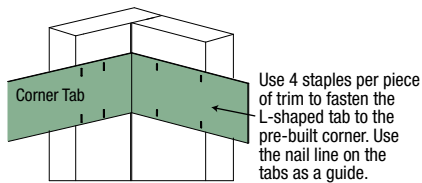


Figure 26

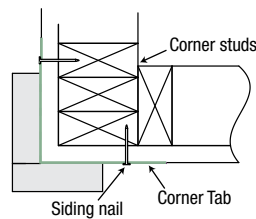
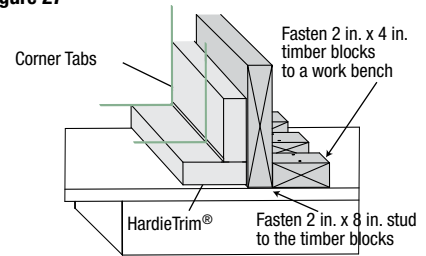


Figure 27



## BAND BOARD

Terminate ends of the Band Board into Trim or Siding or miter cut the edges of the trim at the corners of the building. Place a HardieTrim Flat Tab at the end of each trim board and one tab every stud at a maximum of 16 in. O.C. The HardieTrim Flat Tabs should be attached to the trim in an alternating pattern to the top and bottom of the band board (figures 21, 22). Use 16 ga. galvanized 2 in. long finish nails to ensure proper fastening if needed.

Trim Tab Fastener Table

Application	Framing Material Tab is nailed into	Fastener (tab to framing)	Fastener (tab to trim)	Max Tab Spacing (inches on center)
Flat Tab	Wood Stud (minimum G=0.42)	One 6d corrosion resistant siding nail installed through center of tab into framing	Four 18 ga. X 1/2 in. long X 1/4 in. wide corrosion resistant crown staples, equally spaced in one row	16
	Minimum APA rated 7/16 in. OSB	Two 4d ring shank corrosion resistant siding nails equally spaced installed through tab into framing		
	Minimum 20 gauge steel	One No. 8 X 1 in. long X 0.323 in. head diameter screw (corrosion resistant) installed through flange into framing		
Corner Tab	Wood Stud (minimum G=0.42)	On each flange, Install one 6d corrosion resistant siding nail through tab into framing	For each piece of trim, install Four 18 ga. X 1/2 in. long X 1/4 in. wide corrosion resistant crown staples, equally space in two rows	20
	Minimum APA rated 7/16 in. OSB	On each flange, Install two 4d ring shank corrosion resistant siding nails through tab into framing		
	Minimum 20 gauge steel	On each flange, Install one No. 8 X 1 in. long X 0.323 in. head diameter screw (corrosion resistant) through tab into framing		





## FINISHING

### CUT EDGE TREATMENT

Caulk, paint or prime all field cut edges. James Hardie touch-up kits are required to touch-up ColorPlus products.

### CAULKING

For best results use an Elastomeric Joint Sealant complying with ASTM C920 Grade NS, Class 25 or higher or a Latex Joint Sealant complying with ASTM C834. Caulking/Sealant must be applied in accordance with the caulking/sealant manufacturer's written instructions.

### PAINTING

DO NOT use stain, oil/alkyd base paint, or powder coating on James Hardie Products. James Hardie products must be painted within 180 days for primed product and 90 days for unprimed. 100% acrylic topcoats are recommended. Do not paint when wet. For application rates refer to paint manufacturers specifications. Back-rolling is recommended if the siding is sprayed.

### COLORPLUS TECHNOLOGY CAULKING, TOUCH-UP & LAMINATE

- Care should be taken when handling and cutting James Hardie® ColorPlus® products. During installation use a wet soft cloth or soft brush to gently wipe off any residue or construction dust left on the product, then rinse with a garden hose.
- Touch up nicks, scrapes and nail heads using the ColorPlus® Technology touch-up applicator. Touch-up should be used sparingly. If large areas require touch-up, replace the damaged area with new HardiePlank® lap siding with ColorPlus® Technology.
- Laminate sheet must be removed immediately after installation of each course.
- Terminate non-factory cut edges into trim where possible, and caulk. Color matched caulks are available from your ColorPlus® product dealer.
- Treat all other non-factory cut edges using the ColorPlus Technology edge coaters, available from your ColorPlus product dealer.

**Note:** James Hardie does not warrant the usage of third party touch-up or paints used as touch-up on James Hardie ColorPlus products.

Problems with appearance or performance arising from use of third party touch-up paints or paints used as touch-up that are not James Hardie touch-up will not be covered under the James Hardie ColorPlus Limited Finish Warranty.

### PAINTING JAMES HARDIE SIDING AND TRIM PRODUCTS WITH COLORPLUS TECHNOLOGY

When repainting ColorPlus products, James Hardie recommends the following regarding surface preparation and topcoat application:

- Ensure the surface is clean, dry, and free of any dust, dirt, or mildew
- Repriming is normally not necessary
- 100% acrylic topcoats are recommended
- DO NOT use stain, oil/alkyd base paint, or powder coating on James Hardie® Products.
- Apply finish coat in accordance with paint manufacturers written instructions regarding coverage, application methods, and application temperature
- DO NOT caulk nail heads when using ColorPlus products, refer to the ColorPlus touch-up section

TR1509\_P9/9 09/19

#### SILICA WARNING

**DANGER:** May cause cancer if dust from product is inhaled. Causes damage to lungs and respiratory system through prolonged or repeated inhalation of dust from product. Refer to the current product Safety Data Sheet before use. The hazard associated with fiber cement arises from crystalline silica present in the dust generated by activities such as cutting, machining, drilling, routing, sawing, crushing, or otherwise abrading fiber cement, and when cleaning up, disposing of or moving the dust. When doing any of these activities in a manner that generates dust you must (1) comply with the OSHA standard for silica dust and/or other applicable law, (2) follow James Hardie cutting instructions to reduce or limit the release of dust; (3) warn others in the area to avoid breathing the dust; (4) when using mechanical saw or high speed cutting tools, work outdoors and use dust collection equipment; and (5) if no other dust controls are available, wear a dust mask or respirator that meets NIOSH requirements (e.g. N-95 dust mask). During clean-up, use a well maintained vacuum and filter appropriate for capturing fine (respirable) dust or use wet clean-up methods - never dry sweep.

**! WARNING:** This product can expose you to chemicals including respirable crystalline silica, which is known to the State of California to cause cancer. For more information go to [P65Warnings.ca.gov](http://P65Warnings.ca.gov).

**RECOGNITION:** In accordance with ICC-ES Evaluation Report ESR-2290, HardiePlank® lap siding is recognized as a suitable alternate to that specified in: the 2006,2009,&2012 International Residential Code for One- and Two-Family Dwellings, and the 2006, 2009, & 2012 International Building Code., HardiePlank lap siding is also recognized for application in the following: City of Los Angeles Research Report No. 24862, State of Florida listing FL#889, Dade County, Florida NOA No. 02-0729.02, U.S. Dept. of HUD Materials Release 1263c, Texas Department of Insurance Product Evaluation EC-23, City of New York MEA 223-93-M, and California DSA PA-019. These documents should also be consulted for additional information concerning the suitability of this product for specific applications.



## HardieSoffit® Panel Product Description

### HARDIESOFFIT® PANELS

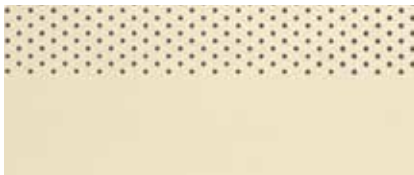
HardieSoffit® panels are 8 ft. and 12 ft. long, ¼ in. thick factory-primed fiber-cement panels designed to be used on the underside of eaves as soffit material. HardieSoffit panels are available as vented or non-vented boards. Vented HardieSoffit panels provide 5 sq. in. of net free ventilation per lineal foot of soffit.

James Hardie offers HardieSoffit panels in a range of time-saving pre-cut widths common to rake and eave applications. HardieSoffit panels come in either a smooth finish or Select Cedarmill® textured finish. Check with your local dealer for product availability. HardieSoffit panels can be combined with HardieTrim® Fascia boards used for fascia rakes and frieze applications to complete the eaves detailing.

HardieSoffit panels are also available with ColorPlus® Technology. The ColorPlus® coating is a factory-applied, oven-baked finish available on a variety of James Hardie® siding and trim products. See your local dealer for details and availability of products, colors and accessories.

### HARDIESOFFIT® BEADED PORCH PANEL

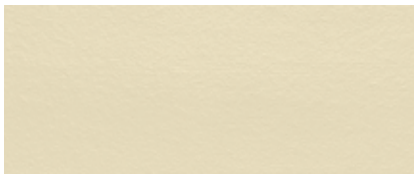
HardieSoffit Beaded Porch Panel is a decorative fiber cement panel to be used as ceiling on the underside of porches or eaves as exterior panel materials. HardieSoffit beaded porch panel is ¼ in. thick, 4 ft. wide, 8 ft. in length, and has 2 in. o.c. beads, and comes with PrimePlus® factory primer and sealer. Must be finished with 100% acrylic paint. See your local dealer for details and availability of products, colors and accessories.



HardieSoffit Vented Smooth



HardieSoffit Vented Cedarmill®

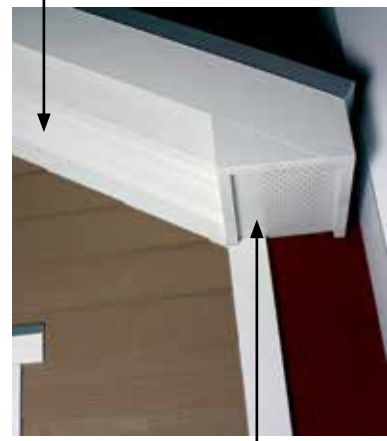


HardieSoffit Non-Vented Smooth

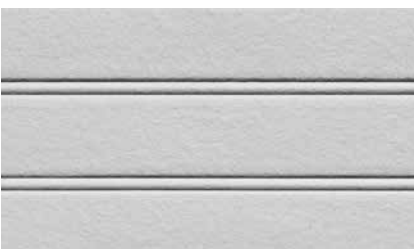


HardieSoffit Non-Vented Cedarmill®

HardieSoffit Non-Vented Smooth



HardieSoffit Vented Smooth



HardieSoffit Beaded Porch Panel



HardieSoffit Beaded Porch Panel

# Installation of HardieSoffit® Panels

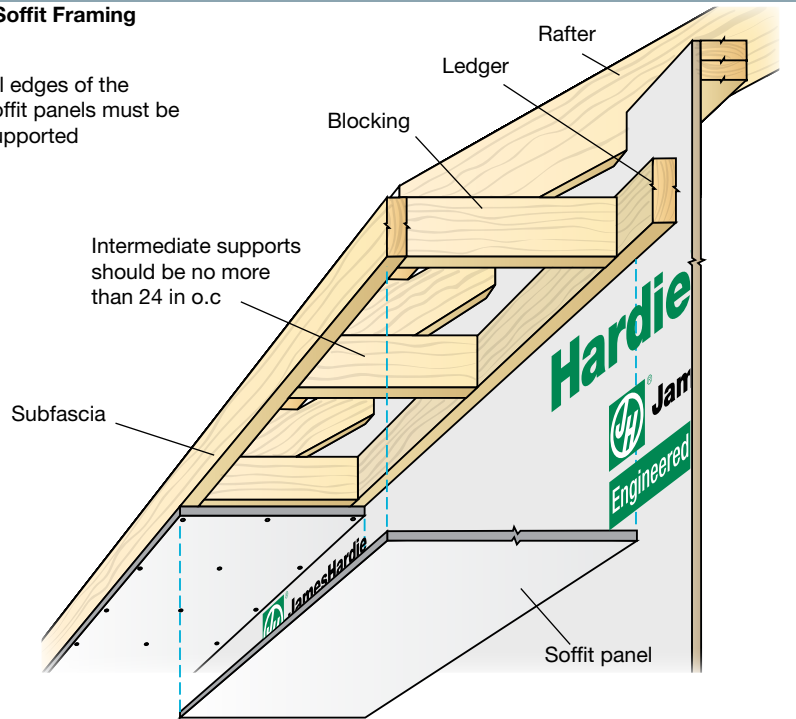
## INSTALLATION OF HARDIESOFFIT® PANELS

HardieSoffit® panels must be attached to solid framing such as 2x4 supports spaced no more than 24 in o.c. For eaves install HardieSoffit panels with the long edge of the panel perpendicular to the ends of the rafters or joists. Eaves framing must include a subfascia, blocking, and/or ledger board to provide solid nailing along the long dimension of the soffit. All panel edges must be supported.

For rake overhangs 2x “look outs” spaced a maximum of 24 in o.c. should support a rake subfascia to provide adequate nailing for the rake soffit. Blocking between the lookouts provides support for the rake soffit along the building.

### 9.1 Soffit Framing

All edges of the soffit panels must be supported

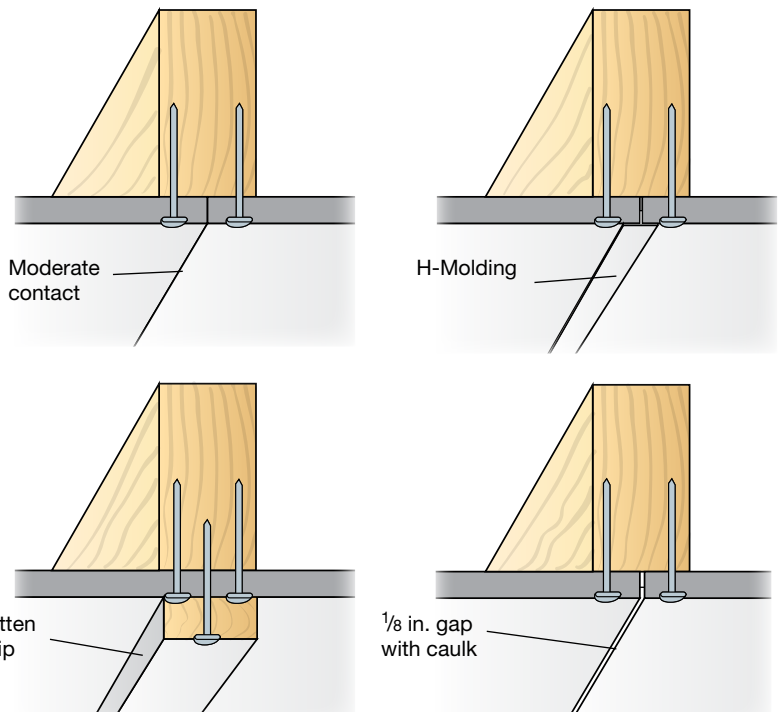


**TIP:** To aid in soffit panel installation, make a “deadman” or “third hand” post to help hold and position the soffit panel. Factory built tools such as those made for drywall installation are available, or they can be fabricated from lumber on the job-site.

## JOINT TREATMENT FOR HARDIESOFFIT PANELS

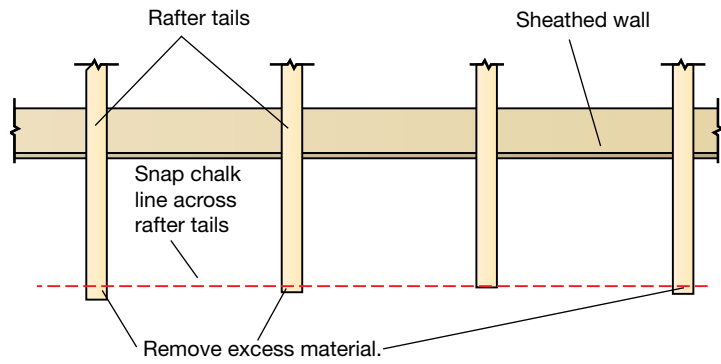
There are several ways to join the lengths of HardieSoffit panels. Panel ends may be lightly butted in moderate contact, the ends may be gapped 1/8 in. and caulked, joints can be covered with batten strips, or panels may be joined with PVC or metal H molding type connectors.

### 9.2

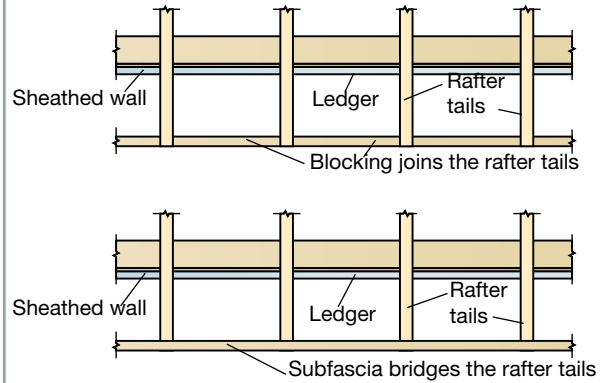


## FRAMING PREP FOR SOFFIT PANELS

9.3



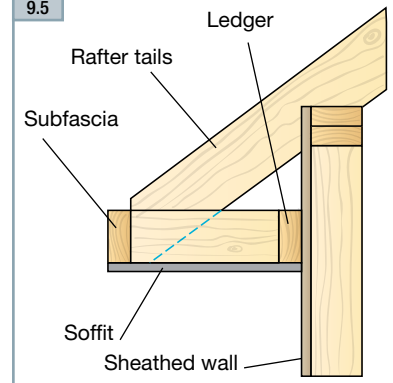
9.4



When installing the soffit:

1. Straighten the rafter tails by pulling and snapping a chalk line across the ends of the tails and then trimming them as necessary.
2. Install a solid wood sub-fascia on the ends of the rafter tails or install blocking between the rafter tails as needed.
3. If the soffit is to be installed level across its width, add nailers at every rafter or truss to provide support.
4. If the eaves are longer than 12 ft, measure and trim the first HardieSoffit® panel making sure that the end falls in the middle of a nailer.
5. Using the subfascia as a guide along the edge, carefully position the panel and secure with 4d common galvanized nails spaced no greater than 8 in. o.c. at all panel edges and on all intermediate framing members.
6. Continue with additional pieces until the run is complete.

9.5

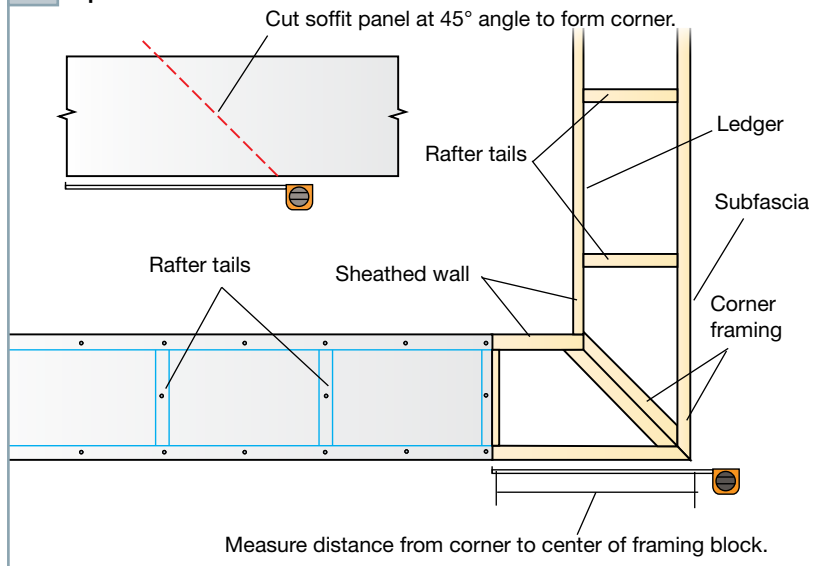


## CUTTING 45° HIP ROOF SOFFITS

Hip roof soffits continue level around the corners of a house. The soffit panels should join at the corner with 45° angle cuts. To create these corners:

1. First measure from the corner to the perpendicular framing member closest to, but not over 12 ft.
2. Using that measurement and pulling from the factory cut end of the soffit panel, mark the outside edge of the soffit panel for the long point of the 45° cut.
3. After cutting the 45° angle, position the panel on the soffit framing and check the fit on both ends before fastening.
4. Begin nailing at the 45° cut end and work toward the factory end.

9.6 Hip roof soffits



### WARNING

When using vented soffit, place the vented section of the panel toward the outside of the eave for optimum airflow.

General  
Product  
Information

Working  
Safety

Tools for  
Cutting and  
Fastening

General  
Installation  
Requirements

General  
Fastener  
Requirements

Finishing and  
Maintenance

HardieWrap®  
Weather Barrier

HardieTrim®  
Boards/Battens

HardieSoffit®  
Panels

HardiePlank®  
Lap Siding

HardieShingle®  
Siding

HardiePanel®  
Vertical Siding

Appendix/  
Glossary

ESR-1844 &  
2290 Report

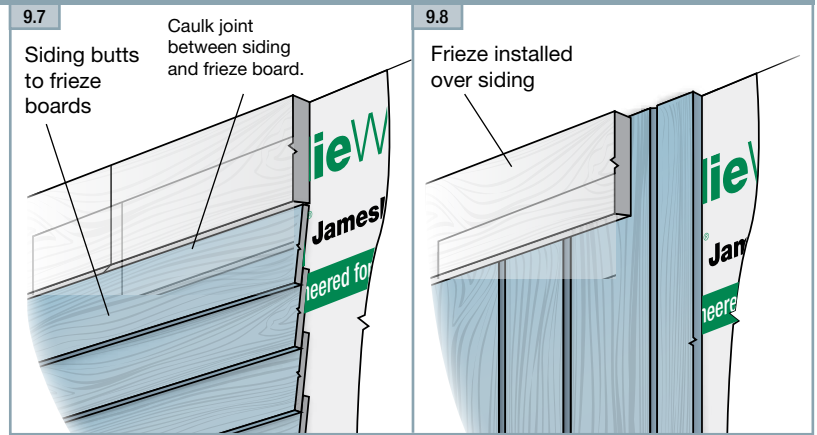
# Installation of HardieSoffit® Panels (cont.)

## INSTALLING FRIEZE BOARDS

### FRIEZE MADE FROM HARDIETRIM®

#### 5/4, 4/4 BOARDS

When using lap and shingle sidings, install HardieTrim 5/4, 4/4 boards as a frieze board before putting in the siding. Then run courses of siding up to the frieze board and caulk the junction of the frieze board and siding. In a building sided with HardiePanel siding, the frieze board is commonly over the panel siding. If joints in the HardieTrim boards frieze are necessary for longer runs, join boards with a bevel cut. Nail the frieze board every 16 in using finish or siding nails.

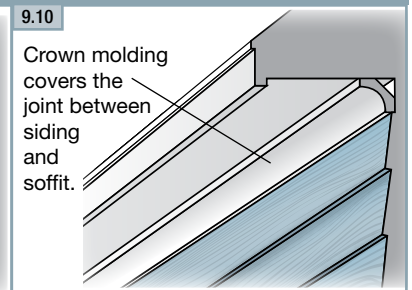
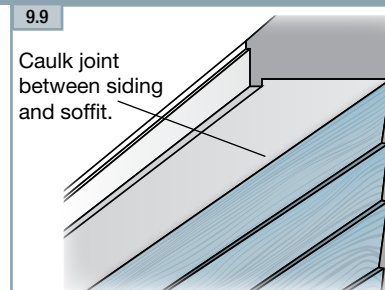


## TREATMENT OPTIONS FOR THE SIDING/SOFFT JUNCTURE

In addition to the frieze board treatments described above, there are several other options for finishing the juncture where the siding meets the soffit.

### CAULK THE SIDING/SOFFT JOINT

A fast and economical method of finishing the siding/soffit juncture is simply to run a bead of quality caulk along the top edge of the siding where it meets the soffit. A straight rip cut along the top edge of the siding ensures an aesthetically pleasing fit where it meets the soffit.

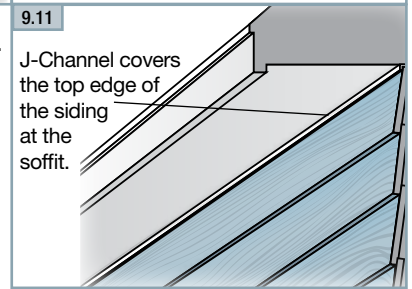


### INSTALL CROWN MOLDING

Crown molding is another way of finishing and sealing the soffit/siding juncture. Install and finish the crown molding according to the manufacturer's specifications.

### OVER THE TOP OF THE SIDING WITH 'J' CHANNEL

Once the soffit is in place, install a vinyl "J" channel upside down with the base of the "J" against the soffit. Then rip the final course of siding so that it fits inside the channel.



## INSECT SCREEN

In areas where additional insect protection is desired, a screen may be applied to the back side of the panel prior to soffit installation. After the screen type and size is selected, cut the screen to fit so that it covers the vent holes and overlaps the non-vented area of the soffit by 1 in. to 2 in. Secure the screen to the backside of the soffit panel using a bead of construction adhesive.

**TIP:** Stainless steel fasteners are recommended when installing James Hardie® products.

## HARDIESOFFT® PANEL FASTENER SPECIFICATIONS

The Fastener Specifications table shows fastener options for a variety of different nailing substrates. Please refer to the applicable ESR report online (see back page) to determine which fastener meets your wind load design criteria.

Fastening Substrate	Approved Fastener	Fastening Types
wood studs	16 in o.c.	① ⑥
	22.5 in o.c.	⑥
	24 in o.c.	①
steel studs	16 in o.c.	⑦

①		4d common
	.113 in x .267 in x 1.5 in	
⑥		ring shank siding nail
	.083 in x .187 in x 1.5 in	
⑦		screw
	Ribbed Bugle-Head No. 8	
	.323 in x 1 in	

**WARNING**

Please note that the addition of an insect screen reduces the total amount of vent area of the soffit depending on the size screen used.

# Installation of HardieSoffit® Beaded Porch Panels

General Product Information

Working Safely

Tools for Cutting and Fastening

General Installation Requirements

General Fastener Requirements

Finishing and Maintenance

HardieWrap® Weather Barrier

HardieTrim® Boards/Battens

HardieSoffit® Panels

HardiePlank® Lap Siding

HardieShingle® Siding

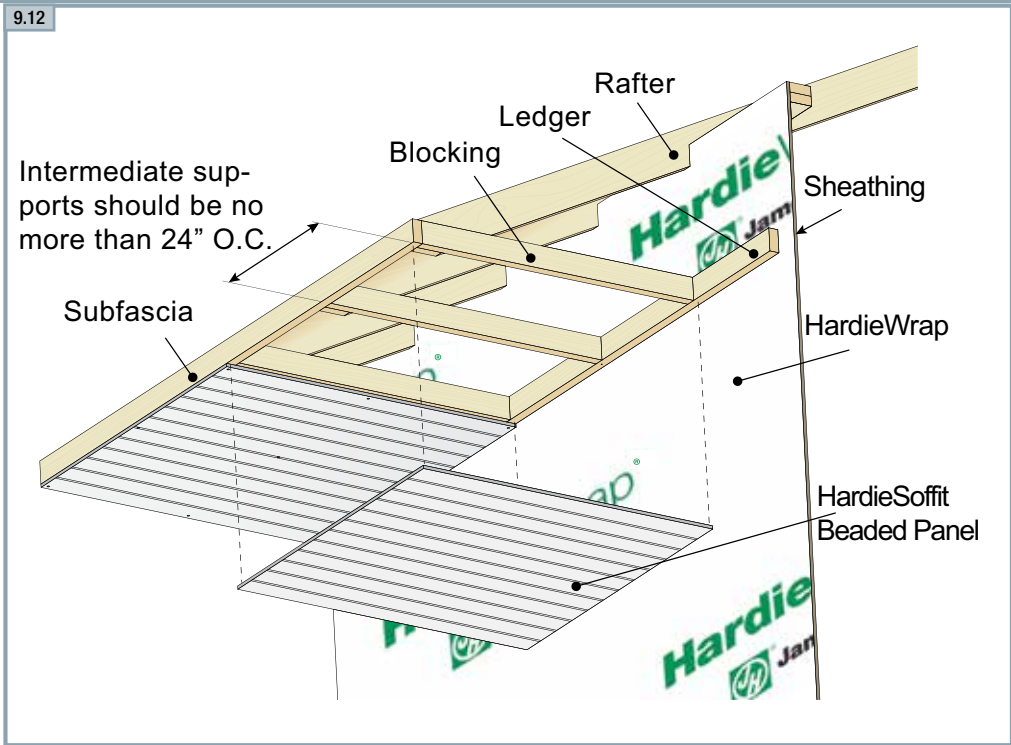
HardiePanel® Vertical Siding

Appendix/ Glossary

ESR-1844 & 2290 Report

## BEADED PORCH PANEL FRAMING

HardieSoffit Beaded Porch Panel must be attached to either steel or wood normal 2x4 framing members spaced a maximum 24 in on center. All edges must be supported by framing.

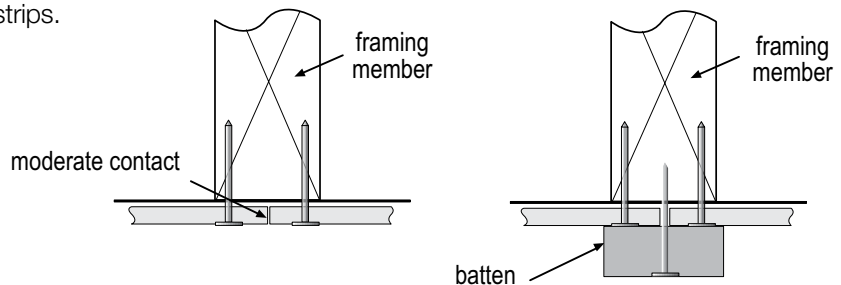


**TIP:** Stainless steel fasteners are recommended when installing James Hardie products near the ocean, large bodies of water, or in very humid climates.

## JOINT TREATMENT FOR BEADED PORCH PANEL

There are several ways to treat the joints of HardieSoffit beaded porch panels. The panel edges can be butted in moderate contact, leave a gap and caulk; or joints can be covered with Hardietrim batten strips.

**TIP:** Do not use finish nails for HardieSoffit beaded porch panel installation.





# Installation of HardieSoffit® Beaded Porch Panels (cont.)

## HANDLING DURING INSTALLATION

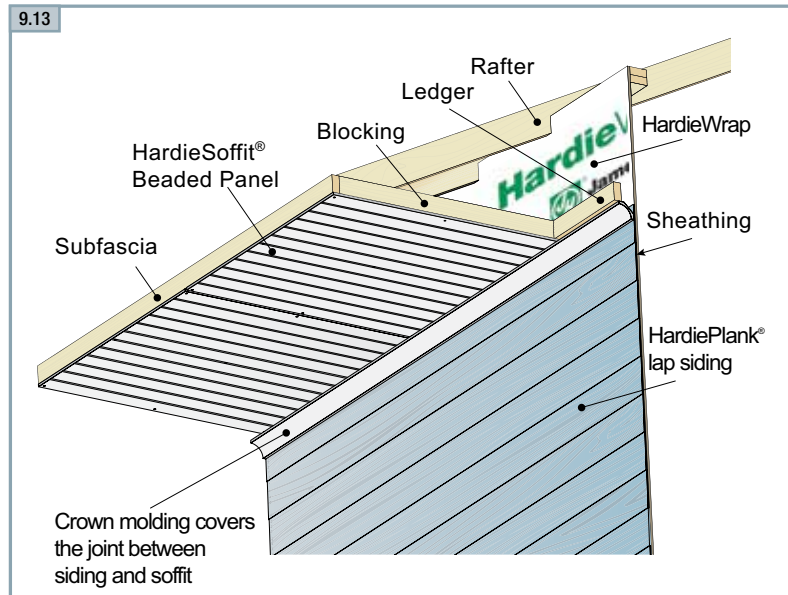
Special precautions may be needed for carrying the panel during installation because of its larger size. James Hardie recommends the use of a T shape frame to support the panel during installation.



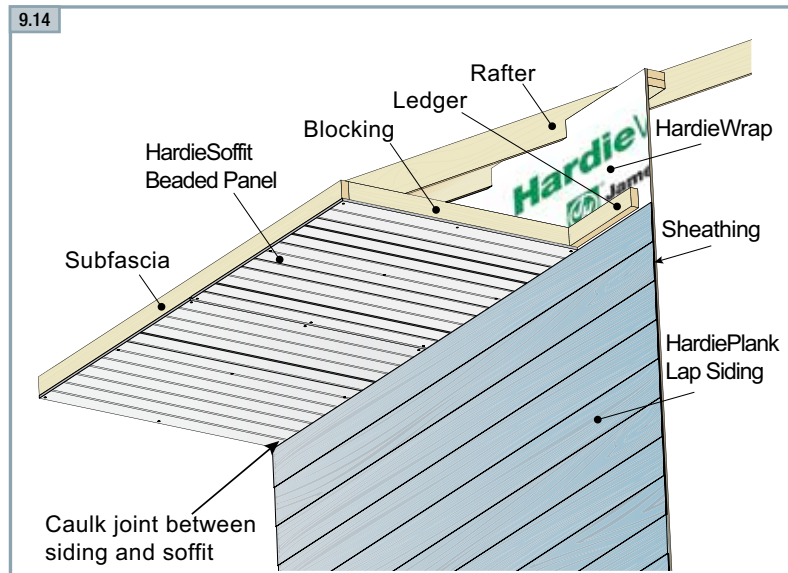
## SIDING/BEADED PORCH PANEL JOINT

A fast and economical method of finishing the siding/porch panel juncture is simply to run a bead of quality caulk along the top edge of the siding where it meets the soffit. A straight rip cut along the top edge of the siding ensures an aesthetically pleasing fit where it meets the beaded porch panel.

9.13



9.14

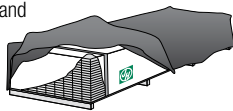




**IMPORTANT: FAILURE TO FOLLOW JAMES HARDIE WRITTEN INSTALLATION INSTRUCTIONS AND COMPLY WITH APPLICABLE BUILDING CODES MAY VIOLATE LOCAL LAWS, AFFECT BUILDING ENVELOPE PERFORMANCE AND MAY AFFECT WARRANTY COVERAGE. FAILURE TO COMPLY WITH ALL HEALTH AND SAFETY REGULATIONS WHEN CUTTING AND INSTALLING THIS PRODUCT MAY RESULT IN PERSONAL INJURY. BEFORE INSTALLATION, CONFIRM YOU ARE USING THE CORRECT HARDIEZONE® PRODUCT INSTRUCTIONS BY VISITING HARDIEZONE.COM OR CALL 1-866-942-7343 (866-9-HARDIE)**

## STORAGE & HANDLING:

Store flat and keep dry and covered prior to installation. Installing siding wet or saturated may result in shrinkage at butt joints. Carry planks on edge. Protect edges and corners from breakage. James Hardie is not responsible for damage caused by improper storage and handling of the product.



## ⚠ CUTTING INSTRUCTIONS

### OUTDOORS

- Position cutting station so that airflow blows dust away from the user and others near the cutting area.
- Cut using one of the following methods:
  - Best:** Circular saw equipped with a HardieBlade® saw blade and attached vacuum dust collection system. Shears (manual, pneumatic or electric) may also be used, not recommended for products thicker than 7/16 in.
  - Better:** Circular saw equipped with a dust collection feature (e.g. Roan® saw) and a HardieBlade saw blade.
  - Good:** Circular saw equipped with a HardieBlade saw blade.

### INDOORS

DO NOT grind or cut with a power saw indoors. Cut using shears (manual, pneumatic or electric) or the score and snap method, not recommended for products thicker than 7/16 in.

- DO NOT dry sweep dust; use wet dust suppression or vacuum to collect dust.
- For maximum dust reduction, James Hardie recommends using the "Best" cutting practices. Always follow the equipment manufacturer's instructions for proper operation.
- For best performance when cutting with a circular saw, James Hardie recommends using HardieBlade® saw blades.
- Go to jameshardiepros.com for additional cutting and dust control recommendations.

**IMPORTANT:** The Occupational Safety and Health Administration (OSHA) regulates workplace exposure to silica dust. For construction sites, OSHA has deemed that cutting fiber cement with a circular saw having a blade diameter less than 8 inches and connected to a commercially available dust collection system per manufacturer's instructions results in exposures below the OSHA Permissible Exposure Limit (PEL) for respirable crystalline silica, without the need for additional respiratory protection.

If you are unsure about how to comply with OSHA silica dust regulations, consult a qualified industrial hygienist or safety professional, or contact your James Hardie technical sales representative for assistance. James Hardie makes no representation or warranty that adopting a particular cutting practice will assure your compliance with OSHA rules or other applicable laws and safety requirements.

## GENERAL REQUIREMENTS:

- HardieSoffit® panels may be installed as a soffit or ceiling over either wood or steel 20 gauge (33 mils) minimum to 16 gauge (54 mils) framing complying with the local building code. See general fastening requirements. Install soffits to nominal 2 x 4 framing members spaced a maximum of 24 inches on center (fig. 1), with the long dimension perpendicular to the rafter or joist framing.
- All edges must be supported by framing. (figs. 3 & 4)
- Install water barriers and air barriers as required by local building codes. James Hardie will assume no responsibility for moisture infiltration.
- Ensure gutters have end caps. Maintain a minimum 1 in gap between end caps and siding & trim (fig.5).
- Install kickout flashing at roof-wall junctions. (fig 6.)
- James Hardie Building Products provides installation /wind load information for buildings with a maximum mean roof height of 85 feet. For information on installations above 60 feet, please contact JH technical support.

## INSTALLATION:

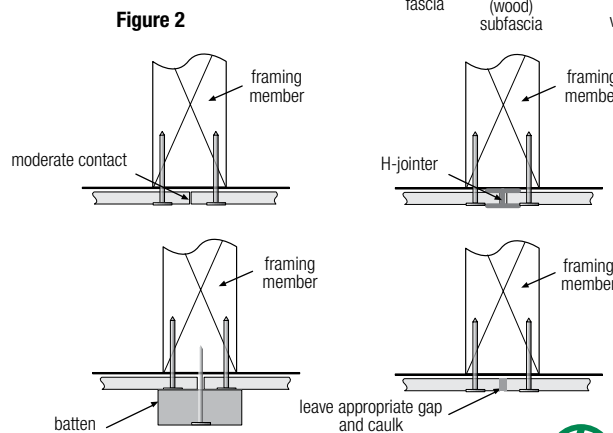
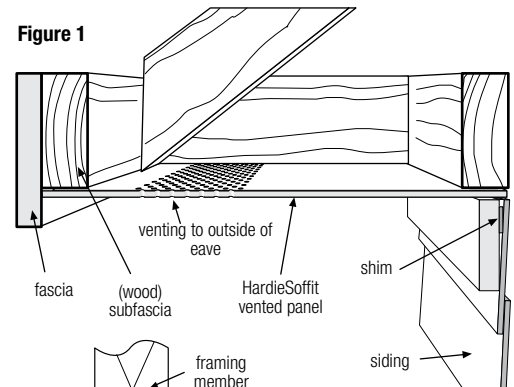
- HardieSoffit panels must be fastened to a solid, nailable substrate such as a wood 2x subfascia.
- Additional framing may be needed to ensure proper fastening.
- Soffits can be installed as shown in figure 1. Position the vent holes toward the outside of the eave for optimal airflow.
- 12 in to 24 in wide Vented HardieSoffit panels, provide 5.0 square inches of net free ventilation per lineal foot.
- Alternatively vents can be installed into non-vented soffit.
- If necessary, an insect screen can be installed using construction adhesive. Note: net free ventilation will be reduced.

### Fastener Positioning

- Position fasteners 3/8 in from panel edges and no closer than 2 in away from corners when using soffit greater than 12 in wide (fig. 4) and no closer than 1 in away from corners when using soffit that is less than or equal to 12 in wide (fig. 3).

### Joining Methods

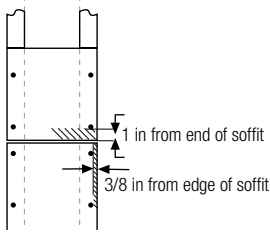
- Install panels in moderate contact at ends, provide PVC or metal jointers, battens or leave appropriate gap and caulk (fig 2).



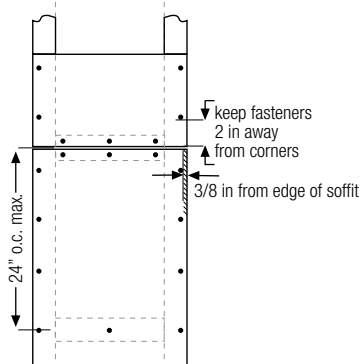
<sup>1</sup>For additional information on HardieWrap® Weather Barrier, consult James Hardie at 1-866-4Hardie or www.hardiewrap.com



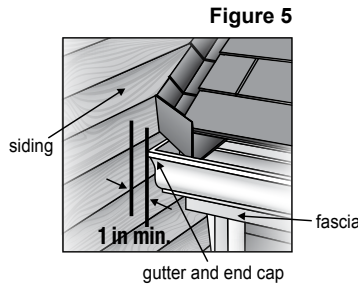
**Figure 3**  
less than or equal to 12 in Wide Soffit



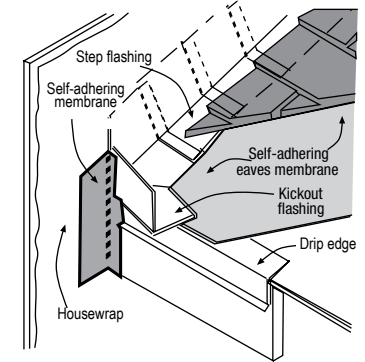
**Figure 4**  
Greater than 12 in Wide Soffit



**Figure 5**  
Maintain a minimum 1 in gap between gutter end caps and siding & trim.



**Figure 6**



### FASTENER REQUIREMENTS

- For wood frame construction a minimum 4d common nails spaced 8 in o.c. at panel edges and intermediate framing members spaced up to 24 in on center are suitable in most locations\*.
- For conventional 20ga - 16ga steel frame construction a minimum No. 8-18 x 0.323 in HD x 1 in long ribbed bugle screws spaced 6 in o.c. at panel edges and intermediate framing members spaced up to 24 in on center are suitable in most locations\*.

\*Minimum Basic Wind Speed differs by locality. Where specified levels of wind resistance are required, refer to applicable Building Code Compliance Reports.

Manufacturers of ACQ and CA preservative-treated wood recommend spacer materials or other physical barriers to prevent direct contact of ACQ or CA preservative-treated wood and aluminum products. Fasteners used to attach HardieTrim Tabs to preservative-treated wood shall be of hot dipped zinc-coated galvanized steel or stainless steel and in accordance to 2009 IRC R317.3 or 2009 IBC 2304.9.5."

### GENERAL FASTENING REQUIREMENTS

Refer to the applicable ESR report online to determine which fastener meets your wind load design criteria. Fasteners must be corrosion resistant, galvanized, or stainless steel. Electro-galvanized are acceptable but may exhibit premature corrosion. James Hardie recommends the use of quality, hot-dipped galvanized nails. James Hardie is not responsible for the corrosion resistance of fasteners. Stainless steel fasteners are recommended when installing James Hardie® products near the ocean, large bodies of water, or in very humid climates.

Manufacturers of ACQ and CA preservative-treated wood recommend spacer materials or other physical barriers to prevent direct contact of ACQ or CA preservative-treated wood and aluminum products. Fasteners used to attach HardieTrim Tabs to preservative-treated wood shall be of hot dipped zinc-coated galvanized steel or stainless steel and in accordance to 2009 IRC R317.3 or 2009 IBC 2304.9.5

- Consult applicable product evaluation or listing for correct fasteners type and placement to achieve specified design wind loads.
- NOTE: Published wind loads may not be applicable to all areas where Local Building Codes have specific jurisdiction. Consult James Hardie Technical Services if you are unsure of applicable compliance documentation.
- Drive fasteners perpendicular to siding and framing.
- Fastener heads should fit snug against siding (no air space).
- NOTE: Whenever a structural member is present, HardiePlank should be fastened with even spacing to the structural member. The tables allowing direct to OSB or plywood should only be used when traditional framing is not available.

### KICKOUT FLASHING

Because of the volume of water that can pour down a sloped roof, one of the most critical flashing details occurs where a roof intersects a sidewall. The roof must be flashed with step flashing. Where the roof terminates, install a kickout to deflect water away from the siding. It is best to install a self-adhering membrane on the wall before the subsfascia and trim boards are nailed in place, and then come back to install the kickout.

**Figure 6, Kickout Flashing** To prevent water from dumping behind the siding and the end of the roof intersection, install a "kickout" as required by IRC code R905.2.8.3 : "...flashing shall be a min. of 4" high and 4" wide." James Hardie recommends the kickout be angled between 100° - 110° to maximize water deflection

### PNEUMATIC FASTENING

James Hardie products can be hand nailed or fastened with a pneumatic tool. Pneumatic fastening is highly recommended. Set air pressure so that the fastener is driven snug with the surface of the siding. A flush mount attachment on the pneumatic tool is recommended. This will help control the depth the nail is driven. If setting the nail depth proves difficult, choose a setting that under drives the nail. (Drive under driven nails snug with a smooth faced hammer - Does not apply for installation to steel framing).

<p><b>DO NOT</b></p> <p><b>UNDER DRIVE</b></p>			
<p><b>IF, THEN</b></p> <table border="0"> <tr> <td> <p><b>WOOD FRAME</b></p> <p>HAMMER FLUSH</p> </td> <td> <p><b>STEEL FRAME</b></p> <p>REMOVE &amp; REPLACE</p> </td> </tr> </table>		<p><b>WOOD FRAME</b></p> <p>HAMMER FLUSH</p>	<p><b>STEEL FRAME</b></p> <p>REMOVE &amp; REPLACE</p>
<p><b>WOOD FRAME</b></p> <p>HAMMER FLUSH</p>	<p><b>STEEL FRAME</b></p> <p>REMOVE &amp; REPLACE</p>		
<p><b>DO NOT</b></p> <p><b>OVER DRIVE</b>      <b>SLANT</b></p>			
<p><b>IF, THEN ADDITIONAL NAIL</b></p> <p><b>FACE NAIL</b></p> <p>COUNTERSINK &amp; FILL</p>			
<p><b>DO NOT USE</b></p> <p><b>ALUMINUM FASTENERS</b></p> <p><b>CLIPPED HEAD NAILS</b></p> <p><b>STAPLES</b></p>			



## CUT EDGE TREATMENT

Caulk, paint or prime all field cut edges. James Hardie touch-up kits are required to touch-up ColorPlus products.

## CAULKING

For best results use an Elastomeric Joint Sealant complying with ASTM C920 Grade NS, Class 25 or higher or a Latex Joint Sealant complying with ASTM C834. Caulking/Sealant must be applied in accordance with the caulking/sealant manufacturer's written instructions.

**Note: some caulking manufacturers do not allow "tooling".**

## PAINTING

DO NOT use stain, oil/alkyd base paint, or powder coating on James Hardie® Products. Factory-primed James Hardie products must be painted within 180 days of installation. 100% acrylic topcoats are recommended. Do not paint when wet. For application rates refer to paint manufacturers specifications. Back-rolling is recommended if the siding is sprayed.

## PAINTING JAMES HARDIE® SIDING AND TRIM PRODUCTS WITH COLORPLUS® TECHNOLOGY

When repainting ColorPlus products, James Hardie recommends the following regarding surface preparation and topcoat application:

- Ensure the surface is clean, dry, and free of any dust, dirt, or mildew
- Repriming is normally not necessary
- 100% acrylic topcoats are recommended
- DO NOT use stain, oil/alkyd base paint, or powder coating on James Hardie® Products.
- Apply finish coat in accordance with paint manufacturers written instructions regarding coverage, application methods, and application temperature
- DO NOT caulk nail heads when using ColorPlus products, refer to the ColorPlus touch-up section

## COLORPLUS® TECHNOLOGY CAULKING, TOUCH-UP & LAMINATE

- Care should be taken when handling and cutting James Hardie® ColorPlus® products. During installation use a wet soft cloth or soft brush to gently wipe off any residue or construction dust left on the product, then rinse with a garden hose.
- Touch up nicks, scrapes and nail heads using the ColorPlus® Technology touch-up applicator. Touch-up should be used sparingly. If large areas require touch-up, replace the damaged area with new HardiePlank® lap siding with ColorPlus® Technology.
- Laminate sheet must be removed immediately after installation of each course.
- Terminate non-factory cut edges into trim where possible, and caulk. Color matched caulks are available from your ColorPlus® product dealer.
- Treat all other non-factory cut edges using the ColorPlus Technology edge coat, available from your ColorPlus product dealer.

**Note:** James Hardie does not warrant the usage of third party touch-up or paints used as touch-up on James Hardie ColorPlus products.

Problems with appearance or performance arising from use of third party touch-up paints or paints used as touch-up that are not James Hardie touch-up will not be covered under the James Hardie ColorPlus Limited Finish Warranty.

SF1204 P/3 12/19

### SILICA WARNING

**DANGER:** May cause cancer if dust from product is inhaled. Causes damage to lungs and respiratory system through prolonged or repeated inhalation of dust from product. Refer to the current product Safety Data Sheet before use. The hazard associated with fiber cement arises from crystalline silica present in the dust generated by activities such as cutting, machining, drilling, routing, sawing, crushing, or otherwise abrading fiber cement, and when cleaning up, disposing of or moving the dust. When doing any of these activities in a manner that generates dust you must (1) comply with the OSHA standard for silica dust and/or other applicable law, (2) follow James Hardie cutting instructions to reduce or limit the release of dust; (3) warn others in the area to avoid breathing the dust; (4) when using mechanical saw or high speed cutting tools, work outdoors and use dust collection equipment; and (5) if no other dust controls are available, wear a dust mask or respirator that meets NIOSH requirements (e.g. N-95 dust mask). During clean-up, use a well maintained vacuum and filter appropriate for capturing fine (respirable) dust or use wet clean-up methods - never dry sweep.

**WARNING:** This product can expose you to chemicals including respirable crystalline silica, which is known to the State of California to cause cancer. For more information go to [P65Warnings.ca.gov](http://P65Warnings.ca.gov).

**RECOGNITION:** In accordance with ICC-ES Evaluation Report ESR-2273, HardieSoffit® panel is recognized as a suitable alternate to that specified in the 2006, 2009, 2012 & 2015 International Residential Code for One and Two-Family Dwellings, and the 2006, 2009, 2012 & 2015 International Building Code. HardieSoffit panel is also recognized for application in the following: State of Florida Product Approval FL13265, Miami-Dade County Florida NOA No. 17-0406.06, U.S. Dept. of HUD Materials Release 1263f, Texas Department of Insurance Product Evaluation EC-23, City of New York MEA 223-93-M, and California DSA PA-019. These documents should also be consulted for additional information concerning the suitability of this product for specific applications.



# HardieSoffit® Beaded Porch Panels

EFFECTIVE APRIL 2018

**IMPORTANT: FAILURE TO FOLLOW JAMES HARDIE WRITTEN INSTALLATION INSTRUCTIONS AND COMPLY WITH APPLICABLE BUILDING CODES MAY VIOLATE LOCAL LAWS, AFFECT BUILDING ENVELOPE PERFORMANCE AND MAY AFFECT WARRANTY COVERAGE. FAILURE TO COMPLY WITH ALL HEALTH AND SAFETY REGULATIONS WHEN CUTTING AND INSTALLING THIS PRODUCT MAY RESULT IN PERSONAL INJURY. BEFORE INSTALLATION, CONFIRM YOU ARE USING THE CORRECT HARDIEZONE® PRODUCT INSTRUCTIONS BY VISITING HARDIEZONE.COM OR CALL 1-866-942-7343 (866-9-HARDIE)**

## STORAGE & HANDLING:

Store flat and keep dry and covered prior to installation. Installing siding wet or saturated may result in shrinkage at butt joints. Carry planks on edge. Protect edges and corners from breakage. James Hardie is not responsible for damage caused by improper storage and handling of the product.



## ⚠ CUTTING INSTRUCTIONS

### OUTDOORS

- Position cutting station so that airflow blows dust away from the user and others near the cutting area.
- Cut using one of the following methods:
  - Best:** Circular saw equipped with a HardieBlade® saw blade and attached vacuum dust collection system. Shears (manual, pneumatic or electric) may also be used, not recommended for products thicker than 7/16 in.
  - Better:** Circular saw equipped with a dust collection feature (e.g. Roan® saw) and a HardieBlade saw blade.
  - Good:** Circular saw equipped with a HardieBlade saw blade.

### INDOORS

- DO NOT grind or cut with a power saw indoors. Cut using shears (manual, pneumatic or electric) or the score and snap method, not recommended for products thicker than 7/16 in.
- DO NOT dry sweep dust; use wet dust suppression or vacuum to collect dust.
  - For maximum dust reduction, James Hardie recommends using the "Best" cutting practices. Always follow the equipment manufacturer's instructions for proper operation.
  - For best performance when cutting with a circular saw, James Hardie recommends using HardieBlade® saw blades.
  - Go to jameshardiepros.com for additional cutting and dust control recommendations.

**IMPORTANT:** The Occupational Safety and Health Administration (OSHA) regulates workplace exposure to silica dust. For construction sites, OSHA has deemed that cutting fiber cement with a circular saw having a blade diameter less than 8 inches and connected to a commercially available dust collection system per manufacturer's instructions results in exposures below the OSHA Permissible Exposure Limit (PEL) for respirable crystalline silica, without the need for additional respiratory protection.

If you are unsure about how to comply with OSHA silica dust regulations, consult a qualified industrial hygienist or safety professional, or contact your James Hardie technical sales representative for assistance. James Hardie makes no representation or warranty that adopting a particular cutting practice will assure your compliance with OSHA rules or other applicable laws and safety requirements.

## GENERAL REQUIREMENTS:

- HardieSoffit® beaded porch panels may be installed as a soffit or ceiling over either wood or steel 20 gauge (33 mils) minimum to 16 gauge (54 mils) framing complying with the local building code. See general fastening requirements. Install soffits to nominal 2 x 4 framing members spaced a maximum of 24" on center (fig. 1), with the long dimension perpendicular to the rafter or joist framing.
- All edges must be supported by framing. (fig. 1)
- Install water barriers and air barriers as required by local building codes. James Hardie will assume no responsibility for moisture infiltration.
- Ensure gutters have end caps. Maintain a minimum 1" gap between end caps and siding & trim (fig. 5).
- Install kickout flashing at roof-wall junctions. (fig 6.)
- DO NOT use finish nails.
- James Hardie Building Products provides installation/wind load information for buildings with a maximum mean roof height of 85 feet. For information on installations above 60 feet, please contact JH technical support.

Figure 1

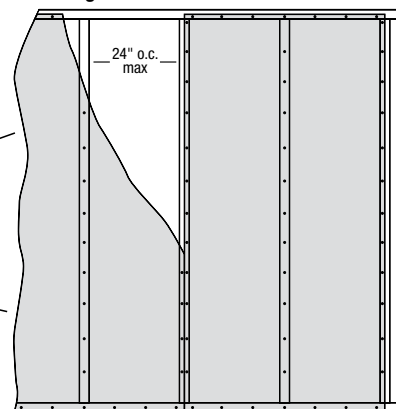
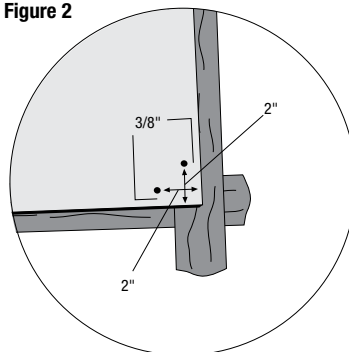


Figure 2



## INSTALLATION:

- HardieSoffit beaded porch panels must be fastened to a solid, nailable substrate such as wood.
- Additional framing may be needed to ensure proper fastening.
- Panels can be installed as shown in figure 1.

### Fastener Positioning

- Position fasteners 3/8" from panel edges and no closer than 2" away from corners (Figure 2).

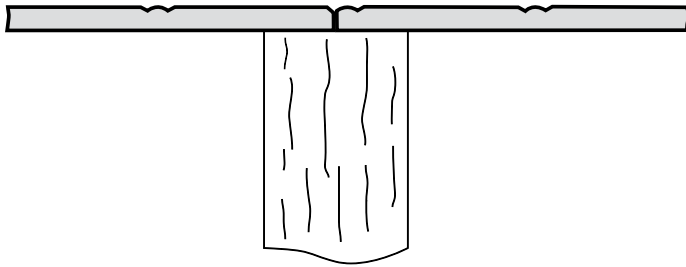
### Joining Methods

- Panel ends are to be butted together as shown in Figure 3.
- Install panels in moderate contact at ends with or without battens (Figure 4).





Figure 3



Maintain a minimum 1" gap between gutter end caps and siding & trim.

Figure 5

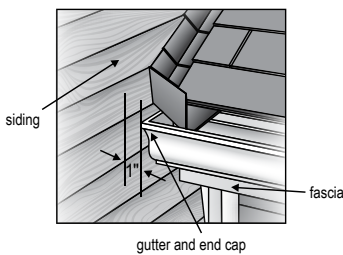


Figure 6

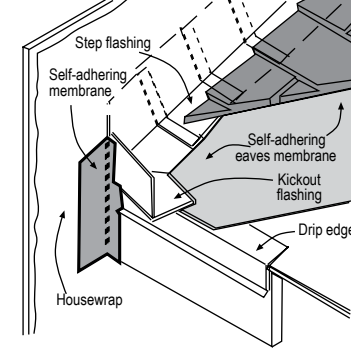
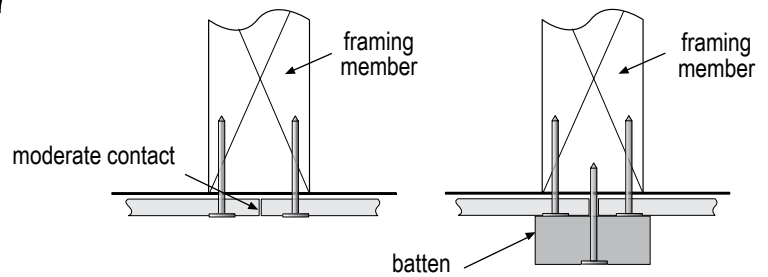


Figure 4



### KICKOUT FLASHING

Because of the volume of water that can pour down a sloped roof, one of the most critical flashing details occurs where a roof intersects a sidewall. The roof must be flashed with step flashing. Where the roof terminates, install a kickout to deflect water away from the siding.

It is best to install a self-adhering membrane on the wall before the subs fascia and trim boards are nailed in place, and then come back to install the kickout.

**Figure 6, Kickout Flashing\*\*** To prevent water from dumping behind the siding and the end of the roof intersection, install a "kickout" as required by IRC code R905.2.8.3 : "...flashing shall be a min. of 4" high and 4" wide." James Hardie recommends the kickout be angled between 100° - 110° to maximize water deflection.

### FASTENER REQUIREMENTS

- For wood frame construction a minimum 4d common nails spaced 8" o.c. at panel edges and intermediate framing members spaced up to 24" on center are suitable in most locations\*.
- For conventional 20-16 ga steel frame construction a minimum No. 8-18 x 0.323" HD x 1" long ribbed bugle screws spaced 6" o.c. at panel edges and intermediate framing members spaced up to 24" on center are suitable in most locations\*.

\*Minimum Basic Wind Speed differs by locality. Where specified levels of wind resistance are required, refer to applicable Building Code Compliance Reports.

### GENERAL FASTENING REQUIREMENTS

Fasteners must be corrosion resistant, galvanized, or stainless steel. Electro-galvanized are acceptable but may exhibit premature corrosion. James Hardie recommends the use of quality, hot-dipped galvanized nails. James Hardie is not responsible for the corrosion resistance of fasteners. Stainless steel fasteners are recommended when installing James Hardie® products near the ocean, large bodies of water, or in very humid climates.

Manufacturers of ACQ and CA preservative-treated wood recommend spacer materials or other physical barriers to prevent direct contact of ACQ or CA preservative-treated wood and aluminum products. Fasteners used to attach HardieTrim Tabs to preservative-treated wood shall be of hot dipped zinc-coated galvanized steel or stainless steel and in accordance to 2009 IRC R317.3 or 2009 IBC 2304.9.5

- Consult applicable product evaluation or listing for correct fasteners type and placement to achieve specified design wind loads.
- NOTE: Published wind loads may not be applicable to all areas where Local Building Codes have specific jurisdiction. Consult James Hardie Technical Services if you are unsure of applicable compliance documentation.
- Drive fasteners perpendicular to siding and framing.
- Fastener heads should fit snug against siding (no air space).
- NOTE: Whenever a structural member is present, HardiePlank should be fastened with even spacing to the structural member. The tables allowing direct to OSB or plywood should only be used when traditional framing is not available.
- **Do not use aluminum fasteners, staples, or clipped head nails.**

### PNEUMATIC FASTENING

James Hardie products can be hand nailed or fastened with a pneumatic tool. Pneumatic fastening is highly recommended. Set air pressure so that the fastener is driven snug with the surface of the siding. A flush mount attachment on the pneumatic tool is recommended. This will help control the depth the nail is driven. If setting the nail depth proves difficult, choose a setting that under drives the nail. (Drive under driven nails snug with a smooth faced hammer - Does not apply for installation to steel framing).

<p><b>SNUG</b>      <b>FLUSH</b></p>		<p><b>DO NOT</b></p> <p><b>UNDER DRIVE</b>      <b>OVER DRIVE</b></p>		<p><b>DO NOT USE</b></p> <p><b>ALUMINUM FASTENERS</b></p> <p><b>CLIPPED HEAD NAILS</b></p> <p><b>STAPLES</b></p>
<p><b>IF, THEN</b></p> <p><b>WOOD FRAME</b>      <b>STEEL FRAME</b></p> <p><b>HAMMER FLUSH</b>      <b>REMOVE &amp; REPLACE</b></p>		<p><b>IF, THEN ADDITIONAL NAIL</b></p> <p><b>FACE NAIL</b></p> <p><b>COUNTERSINK &amp; FILL</b></p>		

\*\*The illustration (figure 6) was reprinted with permission of THE JOURNAL OF LIGHT CONSTRUCTION. For subscription information, visit www.jlconline.com.



## CUT EDGE TREATMENT

Caulk, paint or prime all field cut edges. James Hardie touch-up kits are required to touch-up ColorPlus products.

## CAULKING

For best results use an Elastomeric Joint Sealant complying with ASTM C920 Grade NS, Class 25 or higher or a Latex Joint Sealant complying with ASTM C834. Caulking/Sealant must be applied in accordance with the caulking/sealant manufacturer's written instructions.

**Note: some caulking manufacturers do not allow "tooling".**

## PAINTING

DO NOT use stain, oil/alkyd base paint, or powder coating on James Hardie® Products. Factory-primed James Hardie products must be painted within 180 days of installation. 100% acrylic topcoats are recommended. Do not paint when wet. For application rates refer to paint manufacturers specifications. Back-rolling is recommended if the siding is sprayed.

## PAINTING JAMES HARDIE® SIDING AND TRIM PRODUCTS WITH COLORPLUS® TECHNOLOGY

When repainting ColorPlus products, James Hardie recommends the following regarding surface preparation and topcoat application:

- Ensure the surface is clean, dry, and free of any dust, dirt, or mildew
- Repriming is normally not necessary
- 100% acrylic topcoats are recommended
- DO NOT use stain, oil/alkyd base paint, or powder coating on James Hardie® Products.
- Apply finish coat in accordance with paint manufacturers written instructions regarding coverage, application methods, and application temperature
- DO NOT caulk nail heads when using ColorPlus products, refer to the ColorPlus touch-up section

## COLORPLUS® TECHNOLOGY CAULKING, TOUCH-UP & LAMINATE

- Care should be taken when handling and cutting James Hardie® ColorPlus® products. During installation use a wet soft cloth or soft brush to gently wipe off any residue or construction dust left on the product, then rinse with a garden hose.
- Touch up nicks, scrapes and nail heads using the ColorPlus® Technology touch-up applicator. Touch-up should be used sparingly. If large areas require touch-up, replace the damaged area with new HardiePlank® lap siding with ColorPlus® Technology.
- Laminate sheet must be removed immediately after installation of each course.
- Terminate non-factory cut edges into trim where possible, and caulk. Color matched caulks are available from your ColorPlus® product dealer.
- Treat all other non-factory cut edges using the ColorPlus Technology edge coat, available from your ColorPlus product dealer.

**Note:** James Hardie does not warrant the usage of third party touch-up or paints used as touch-up on James Hardie ColorPlus products.

Problems with appearance or performance arising from use of third party touch-up paints or paints used as touch-up that are not James Hardie touch-up will not be covered under the James Hardie ColorPlus Limited Finish Warranty.

SF1205-P3/3 04/18

### SILICA WARNING

**DANGER:** May cause cancer if dust from product is inhaled. Causes damage to lungs and respiratory system through prolonged or repeated inhalation of dust from product. Refer to the current product Safety Data Sheet before use. The hazard associated with fiber cement arises from crystalline silica present in the dust generated by activities such as cutting, machining, drilling, routing, sawing, crushing, or otherwise abrading fiber cement, and when cleaning up, disposing of or moving the dust. When doing any of these activities in a manner that generates dust you must (1) comply with the OSHA standard for silica dust and/or other applicable law, (2) follow James Hardie cutting instructions to reduce or limit the release of dust; (3) warn others in the area to avoid breathing the dust; (4) when using mechanical saw or high speed cutting tools, work outdoors and use dust collection equipment; and (5) if no other dust controls are available, wear a dust mask or respirator that meets NIOSH requirements (e.g. N-95 dust mask). During clean-up, use a well maintained vacuum and filter appropriate for capturing fine (respirable) dust or use wet clean-up methods - never dry sweep.

**WARNING:** This product can expose you to chemicals including respirable crystalline silica, which is known to the State of California to cause cancer. For more information go to [P65Warnings.ca.gov](http://P65Warnings.ca.gov).

**RECOGNITION:** In accordance with ICC-ES Evaluation Report ESR-2273, HardieSoffit® panel is recognized as a suitable alternate to that specified in the 2006, 2009, 2012 & 2015 International Residential Code for One and Two-Family Dwellings, and the 2006, 2009, 2012 & 2015 International Building Code. HardieSoffit panel is also recognized for application in the following: State of Florida Product Approval FL13265, Miami-Dade County Florida NOA No. 17-0406.06, U.S. Dept. of HUD Materials Release 1263f, Texas Department of Insurance Product Evaluation EC-23, City of New York MEA 223-93-M, and California DSA PA-019. These documents should also be consulted for additional information concerning the suitability of this product for specific applications.

## HardiePlank® Lap Siding Product Description

HardiePlank® lap siding is factory-primed fiber-cement lap siding available in a variety of styles and textures. Please see your local James Hardie® product dealer for product availability. HardiePlank lap siding comes in 12 ft. lengths. Nominal widths from 5 1/4 in to 12 in. create a range of exposures from 4 in to 10 3/4 in

HardiePlank lap siding is also available with ColorPlus® Technology as one of James Hardie's prefinished products. ColorPlus® Technology is a factory applied, oven-baked finish available on a variety of James Hardie siding and trim products. See your local dealer for details and availability of products, colors, and accessories.

The HZ5® product line is right at home in climates with freezing temperatures, seasonal temperature variations, snow and ice. HZ5® boards are the result of our generational evolution of our time-tested products. We've evolved our substrate composition to be specifically designed to perform in conditions found in these climates. To ensure that its beauty matches its durability, we've engineered the surface for higher performance, giving it superior paint adhesion and moisture resistance. In addition, we've added a drip edge to the HardiePlank® HZ5® lap siding product to provide improved water management in conditions specific to HZ5® climates.



Select Cedarmill®



Smooth



Beaded Cedarmill®



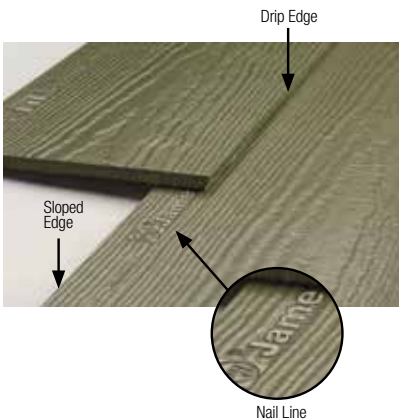
Beaded Smooth



Custom Colonial Roughsawn®



Custom Colonial Smooth®

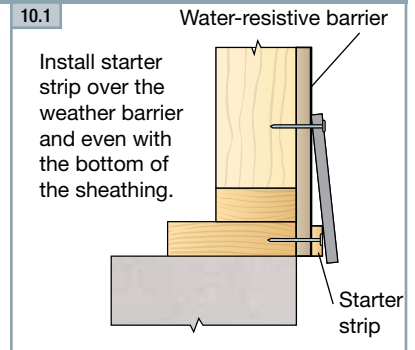


# Installation of HardiePlank® Lap Siding

## INSTALL A STARTER STRIP

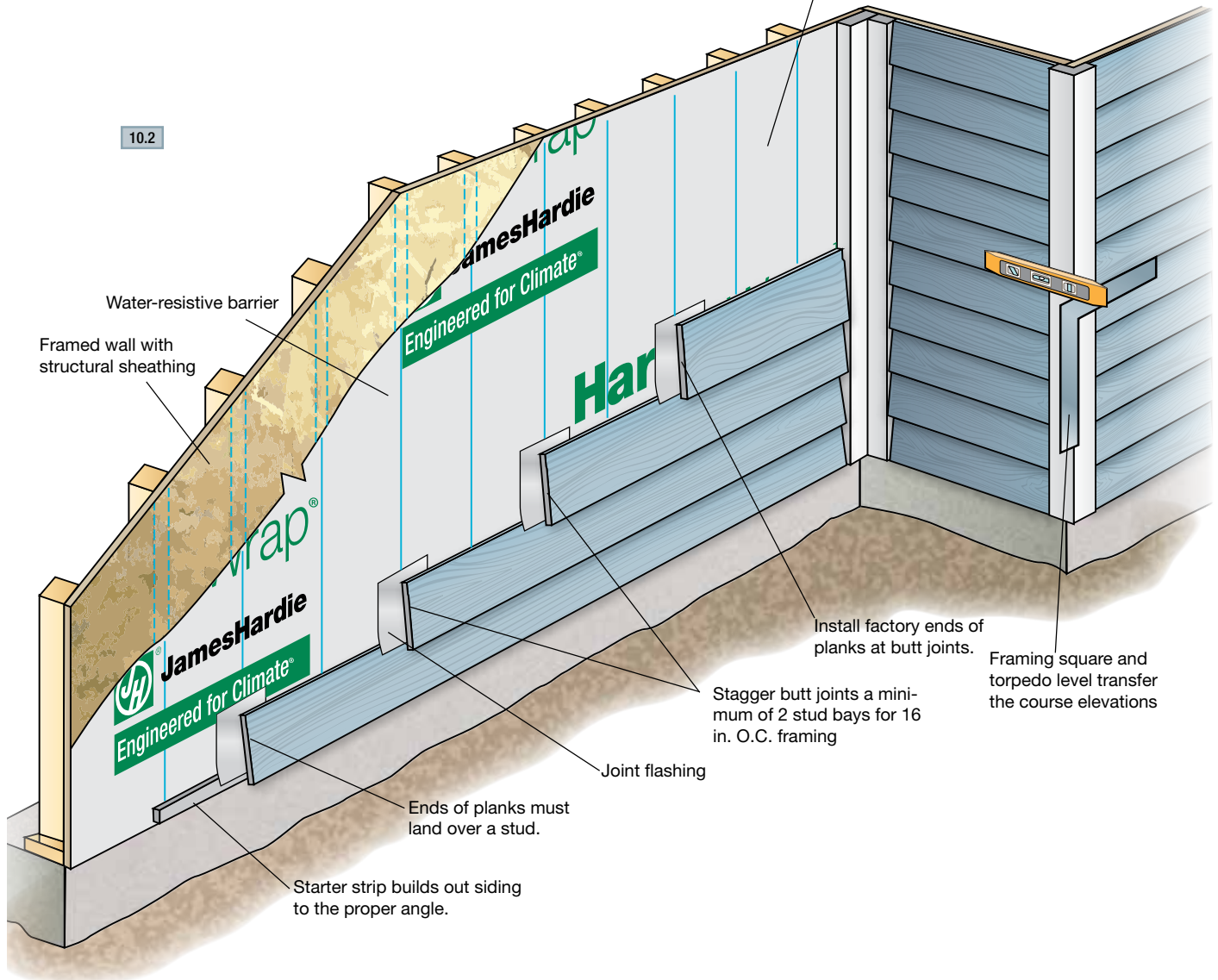
HardiePlank® lap siding requires a starter strip beneath the first course to set it on the proper angle and to create a proper drip edge at the bottom of the siding. Starter strips are easily made by ripping 1 ¼ in. pieces of HardiePlank siding from full or partial planks.

The bottom of the starter strip should be installed even with the bottom of the mudsill or the bottom edge of the sheathing. The strip must be installed over the water-resistant barrier, but occasional gaps should be left in the starter strip to allow any accumulated moisture behind the siding to drain away safely.



## OVERVIEW OF HARDIEPLANK LAP SIDING

**TIP:** For accurate fastening, snap vertical chalk lines on the water-resistant barrier at the center of every stud location.



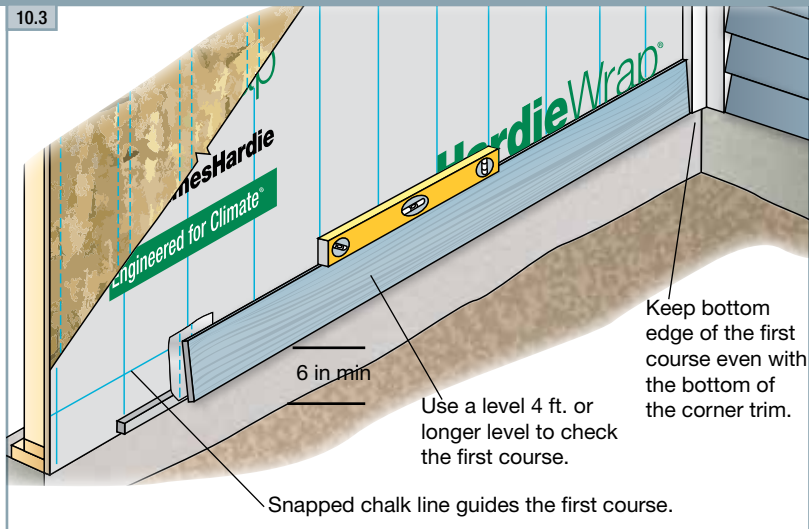


## INSTALLING THE PLANKS

The first course of HardiePlank® siding is critical to the proper installation of the plank on the rest of the building. The first course should start at the lowest point of the house and within required clearances. Special attention should be made to ensure that it's straight and level. Attention should also be paid to staggering any butt joints in the planks so that the installation is attractive while making efficient use of material.

1. Use a level (4 ft. or longer) or chalked level line to be sure that the first course is level. As installation proceeds up the wall, periodically check the level and straightness of the courses. When correcting for flatness over products such as exterior insulation, use drywall shims. It is good practice to snap a chalk line every 3 to 5 courses to keep the planks straight and level.
2. Position the bottom edge of the first course of siding a minimum  $\frac{1}{4}$  in below the edge of the starter strip (maintain required clearances) and secure.
3. Run the siding to the HardieTrim® board leaving a  $\frac{1}{8}$  in. gap between the siding and trim.

The bottom of the siding should be kept even with the bottom of the trim, or if desired, the trim may extend below the bottom of the siding. But the siding should never hang below the trim. **\*When installing the first course make sure ground clearances are in accordance with James Hardie requirements and those of local codes.**

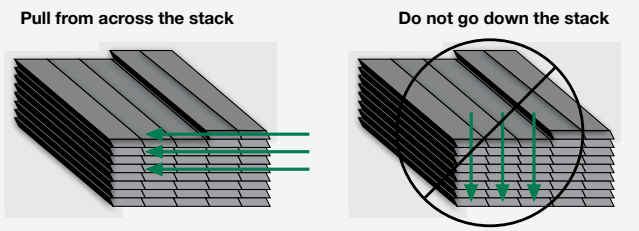


## PLANK ALIGNMENT AT CORNERS

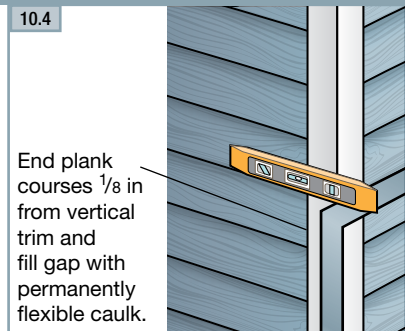
For the best looking installation, make sure that the heights of the plank courses match on both sides of a corner. Use a framing square, speed square or a level to match up the plank heights. Check every few courses to make sure proper heights are being maintained.

## HANDLING

**IMPORTANT:** To prevent damage to the drip edge, extra care should be taken when removing planks from the pallet, while handling, and when installing with a lap gauge. Planks are interlocked together on the pallet, therefore they should be removed from the pallet horizontally (side to side) to allow planks to unlock themselves from one another.



**TIP:** When taking planks from the pallet installation, avoid repeating the texture pattern by working across the pallet. Two to four planks can be removed from a stack at one time. But then material should be taken from adjacent stacks, again working across the pallet. Texture repeat is typically a concern on large walls with few breaks such as windows or doors.





# Installation of HardiePlank® Lap Siding (cont.)

## BLIND NAILING (nailing through top of plank)

Blind nailing is recommended for installing any type of HardiePlank® lap siding including ColorPlus® siding. With blind nailing, each course covers the fasteners on the course below, which provides a better looking installation.

For blind nailing HardiePlank lap siding, James Hardie recommends driving fasteners 1 in. from the top edge of the plank. Additionally fasteners should be

placed no closer than 3/8 in from the ends of the plank.

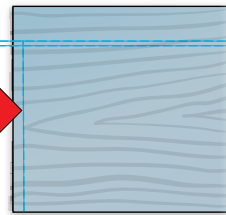
HardiePlank® HZ5® Lap Siding is manufactured with a nail line that should be used as a guide for proper nail placement when blind nailing. This nail line should not be used as a lap line.

Avoid placing fasteners near the top edge of the plank. This practice, called “high nailing”, may lead to loose planks, unwanted gaps or rattling. **Pin-backed corners may be done for aesthetic purposes only. Finish nails are recommended for pin-backs. Headed siding nails are allowed. Place pin-backs no closer than 1 in. from plank ends & 3/4 in. from plank edge into min. 3/8 in. wood structural panel. Pin-backs are not a substitute for blind or face nailing**

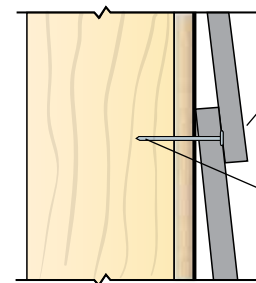
### 10.5 Blind nailing measurements

Nails for blind nailing shall be between 3/4 in and 1 in. from the top of the board.

Keep nails 3/8 in from ends of boards.



### 10.6 Blind nailing



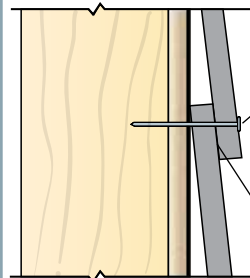
Fasteners are hidden by the course above.

Nails are driven through the sheathing into the studs.

## FACE NAILING (nailing through the overlap at the bottom of the plank)

Although blind nailing is recommended by James Hardie, face nailing may be required for certain installations including: installations in high wind areas, fastening into OSB or equivalent sheathing without penetrating a stud, or when dictated by specific building codes. Refer to Appendix D for related code matters.

### 10.7 Face nailing



Exposed fasteners are driven through the face of the boards.

Drive fasteners only where planks overlap

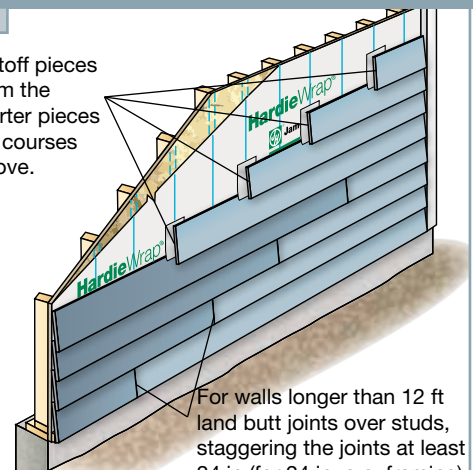
## STAGGERING THE BUTT JOINTS

For walls longer than 12 ft, it is necessary to butt joint additional lengths of HardiePlank siding. These butt joints should be staggered to avoid noticeable patterns, which is determined by the placement of the first course. Butt joints between consecutive courses should be spaced apart by at least two stud bays for 16 in. o.c. framing or one bay for 24 in. o.c. framing.

While random placement of the planks is usually the most aesthetically pleasing, a progressive stagger pattern can make the job easier and faster without the pattern becoming too noticeable. With this strategy, the cut off piece for one course becomes the starter piece for a course above, making efficient use of materials and ensuring that all butt joints land on studs. The pattern can be modified for different stud placement.

### 10.8

Cutoff pieces form the starter pieces for courses above.



For walls longer than 12 ft land butt joints over studs, staggering the joints at least 24 in (for 24 in. o.c. framing) or 32 in. (two stud bays for 16 in. o.c. framing).

## JOINT FLASHING

One or more of the following joint treatment options are required by code (as referenced 2009 IRC R703.10.2)

- A. Joint Flashing (James Hardie recommended)
- B. Caulking\* (Caulking is not recommended for ColorPlus for aesthetic reasons as the Caulking and ColorPlus will weather differently. For the same reason, do not caulk nail heads on ColorPlus products.)
- C. "H" jointer cover

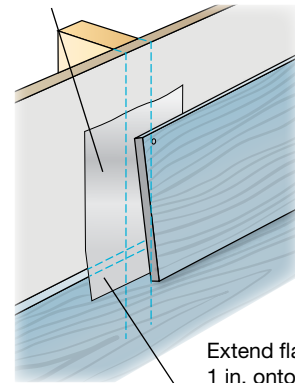
Flashing behind butt joints provides an extra level of protection against the entry of water at the joint. James Hardie recommends 6 in. wide flashing that overlaps the course below by 1 in. Some local building codes may require different size flashing.

Joint-flashing material must be durable, waterproof materials that do not react with cement products. Examples of suitable material include finished coil stock and code compliant water-resistive barriers. Other products may also be suitable.

**TIP:** Joint flashing can be quickly and easily made by cutting a 6 in. wide section off a roll of housewrap. Tape the roll tightly at the cut mark and cut the section off using a miter saw with a carbide blade. Individual sheets then can be cut to length with a utility knife.

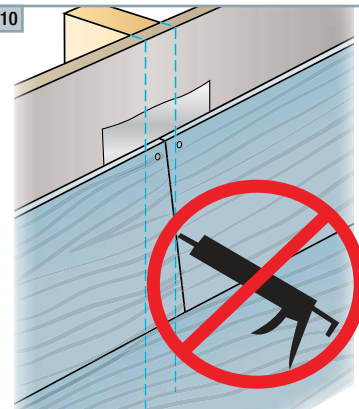
**TIP:** Use light-colored joint flashing when using light-colored ColorPlus lap siding or other siding with a light-colored finish. Dark-color joint flashings should be used on siding with dark finishes.

10.9 Flashing behind to add an additional layer of protection from water infiltration



Extend flashing 1 in. onto the course below

10.10

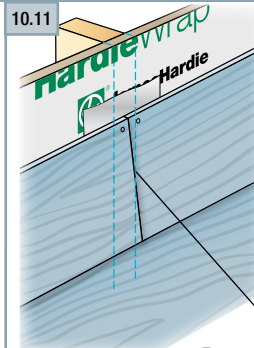


Caulking at HardiePlank lap siding butt joints is not recommended for ColorPlus for aesthetic reasons as the caulking and ColorPlus will weather differently. For the same reason, do not caulk exposed nail heads. Refer to the ColorPlus touch-up section for details

## JOINT PLACEMENT AND TREATMENT

Butt joints in HardiePlank lap siding should always land on a stud. Butt joints between studs are not recommended and should be avoided. Whenever possible, factory-finished ends should be used at butt joints.

Place cut ends where the siding meets a corner, door, window trim, or other break in the wall where the joint is to be caulked. If cut ends are used in a butt joint between planks, James Hardie requires sealing cut ends for all products. For ColorPlus products, use the color-matched edge coater to seal the cut end.



Butt planks with moderate edge contact

**COLORPLUS® TIP:** When installing HardiePlank lap siding with ColorPlus Technology, position the plank in the immediate area where the plank is to be fastened. Do not place the plank on the course below and slide into position. Doing so may scuff or scratch the ColorPlus finish on the installed piece.

# Installation of HardiePlank® Lap Siding (cont.)

## CONTINUING THE INSTALLATION

Once the initial course of HardiePlank® siding is fastened to the wall, continue installing successive courses with full 12 ft. pieces (follow the stagger pattern for longer walls), or until a window, door or other opening interrupts the course (fig 10.12). Notch planks as needed to fit around windows and doors. Again, be sure to seal all cut edges. Avoid placing butt joints directly above or below windows or above doors. Separate the joint from the opening by at least one course of siding.

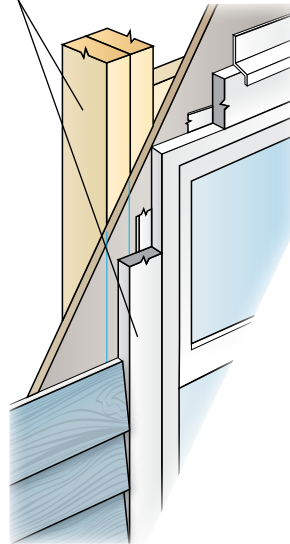
Where butt joints land on a stud, make sure there is enough stud space for plank on both sides of the joint to land properly. Optimally both sides of a butt joint should land in the middle of a stud with 3/4 in landing space for each side. The minimum stud space for a plank to land is 3/8 in

Pay special attention to window, doors, and corners that have been trimmed before the siding goes on. Vertical trim boards may cover the king studs beside windows or doors, or they may cover up corner studs leaving no room for nailing the siding. In these places add extra studs as needed.

If corners are trimmed with HardieTrim® 5/4, 4/4 boards, it may be necessary to measure and cut the first pieces of siding to make sure the butt joints land on studs.

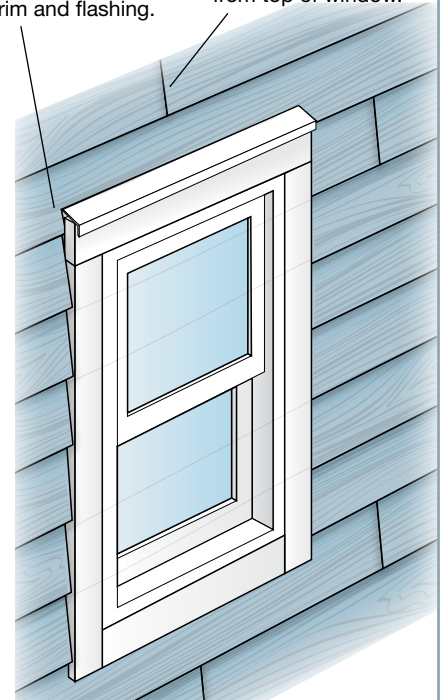
### 10.12 Planking around windows

Add an extra stud if necessary for nailing the ends of the planks.



Notch plank around window trim and flashing.

Keep butt joints more than one course away from top of window.



**COLORPLUS TIP:** HardiePlank lap siding with ColorPlus Technology is shipped with a protective laminate slip sheet, which should be left in place during cutting and fastening to reduce marring and scratching. The sheet should be removed immediately after each plank is installed.



## INSTALLING HARDIEPLANK® SIDING ON GABLE WALLS

Siding gable walls can be challenging, and some of the keys to siding gable walls efficiently are determining the angle or pitch of the roof, properly staging materials, and ensuring that the plank lengths are measured accurately.

To estimate the amount of siding needed to complete a gable end, use the estimating tools located in Appendix C.

Stage enough material on the pump jacks or scaffolding to complete the gable end, but take care not to overload the staging. When possible, a cut table should be located on the pump jacks or scaffolding, which frees up crew members to work on other walls.

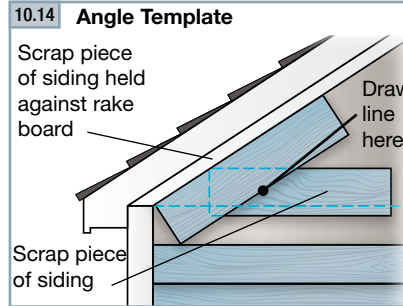
### To cut planks for the gable:

1. Tack up a small scrap piece of siding where the first gable course is going.
2. Hold a second small piece of siding against the eave or rake board.
3. Trace the angle onto the scrap.
4. Cut that line and label the scrap as the template for the gable angle. The template can then be used to transfer the angle onto the larger pieces for cutting and installation.
5. Periodically check the angle as you progress up the wall.

### The quickest way to measure and cut consecutive courses of siding for a gable is to work off the previous piece.

1. Cut and fit the lowest course of siding.
2. Before installing, lay it flat and measure down 1 1/4 in. from the top edge of the plank for the course overlap. Make a mark on both ends.
3. Set a piece of uncut siding on top of the first piece, aligning the bottom edge with the overlap marks. Transfer the length directly to the uncut piece.
4. Draw the gable angle with the template, cut the angle and then repeat the process for the next course.

**TIP:** Stainless steel fasteners are recommended when installing James Hardie® products.



**10.13**

4 Draw the angle, cut and repeat the process for the next course.

**Tip for fast gable installation**

3 Place a plank for the next piece on the overlap lines and mark the length.

2 Before installing, measure down the 1 1/4 in. overlap at the top of the board.

1 Measure, cut and fit lowest gable plank using gable angle template.

### HARDIEPLANK® SIDING FASTENER SPECIFICATIONS

The Fastener Specifications table shows fastener options for a variety of different nailing substrates. Please refer to the applicable ESR report online (see back page) to determine which fastener meets your wind load design criteria.

Fastener Substrate		Approved Fastener	Fastener Type
wood studs	blind nail	16 in o.c.	②  6D common
		24 in o.c.	③ ⑨  6D siding nail
	face nail	16 in o.c.	② ⑤  roofing nail
		24 in o.c.	② ⑤  screws
steel studs*	blind nail	16 in o.c.	⑧ ⑬  screws
		24 in o.c.	⑧ ⑬  ET&F
	face nail	16 in o.c.	⑦ ⑫  ET&F
		24 in o.c.	⑦ ⑫  masonry nail
Direct to Masonry		⑭  8D common	
7/16 in OSB or equivalent (face nailed)		④  roofing nail	
			④  4D siding nail

\*When blind fastening 9.5 in or wider product onto steel studs, use screws.

● indicates recommended fasteners





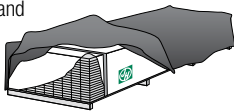
# HardiePlank® Lap Siding

EFFECTIVE SEPTEMBER 2019

**IMPORTANT: FAILURE TO FOLLOW JAMES HARDIE WRITTEN INSTALLATION INSTRUCTIONS AND COMPLY WITH APPLICABLE BUILDING CODES MAY VIOLATE LOCAL LAWS, AFFECT BUILDING ENVELOPE PERFORMANCE AND MAY AFFECT WARRANTY COVERAGE. FAILURE TO COMPLY WITH ALL HEALTH AND SAFETY REGULATIONS WHEN CUTTING AND INSTALLING THIS PRODUCT MAY RESULT IN PERSONAL INJURY. BEFORE INSTALLATION, CONFIRM YOU ARE USING THE CORRECT HARDIEZONE® PRODUCT INSTRUCTIONS BY VISITING HARDIEZONE.COM OR CALL 1-866-942-7343 (866-9-HARDIE)**

## STORAGE & HANDLING:

Store flat and keep dry and covered prior to installation. Installing siding wet or saturated may result in shrinkage at butt joints. Carry planks on edge. Protect edges and corners from breakage. James Hardie is not responsible for damage caused by improper storage and handling of the product.



## ⚠ CUTTING INSTRUCTIONS

### OUTDOORS

- Position cutting station so that airflow blows dust away from the user and others near the cutting area.
- Cut using one of the following methods:
  - Best:** Circular saw equipped with a HardieBlade® saw blade and attached vacuum dust collection system. Shears (manual, pneumatic or electric) may also be used, not recommended for products thicker than 7/16 in.
  - Better:** Circular saw equipped with a dust collection feature (e.g. Roan® saw) and a HardieBlade saw blade.
  - Good:** Circular saw equipped with a HardieBlade saw blade.

### INDOORS

DO NOT grind or cut with a power saw indoors. Cut using shears (manual, pneumatic or electric) or the score and snap method, not recommended for products thicker than 7/16 in.

- DO NOT dry sweep dust; use wet dust suppression or vacuum to collect dust.
- For maximum dust reduction, James Hardie recommends using the "Best" cutting practices. Always follow the equipment manufacturer's instructions for proper operation.
- For best performance when cutting with a circular saw, James Hardie recommends using HardieBlade® saw blades.
- Go to jameshardiepros.com for additional cutting and dust control recommendations.

**IMPORTANT:** The Occupational Safety and Health Administration (OSHA) regulates workplace exposure to silica dust. For construction sites, OSHA has deemed that cutting fiber cement with a circular saw having a blade diameter less than 8 inches and connected to a commercially available dust collection system per manufacturer's instructions results in exposures below the OSHA Permissible Exposure Limit (PEL) for respirable crystalline silica, without the need for additional respiratory protection.

If you are unsure about how to comply with OSHA silica dust regulations, consult a qualified industrial hygienist or safety professional, or contact your James Hardie technical sales representative for assistance. James Hardie makes no representation or warranty that adopting a particular cutting practice will assure your compliance with OSHA rules or other applicable laws and safety requirements.

**IMPORTANT:** To prevent damage to the drip edge, extra care should be taken when removing planks from the pallet, while handling, and when installing with a lap gauge. Please see additional handling requirements on page 4.

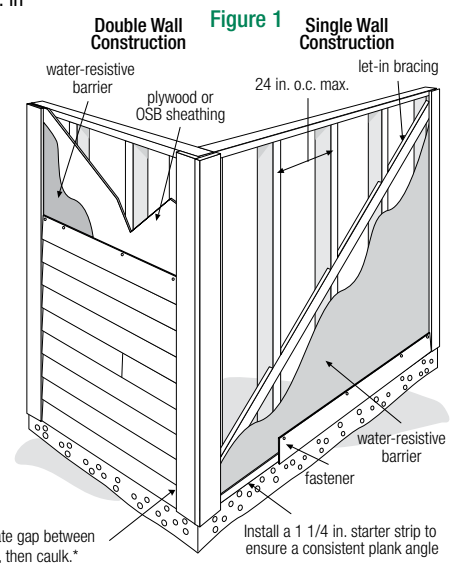
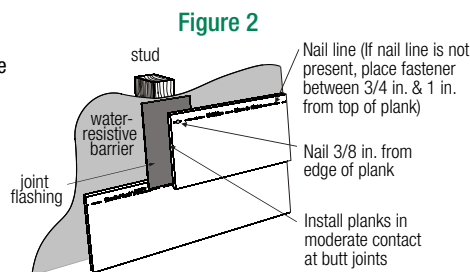
## GENERAL REQUIREMENTS:

- HardiePlank® lap siding can be installed over braced wood or steel studs, 20 gauge (33 mils) minimum to 16 gauge (54 mils) maximum, spaced a maximum of 24 in o.c. or directly to minimum 7/16 in thick OSB sheathing. See General Fastening Requirements. Irregularities in framing and sheathing can mirror through the finished application. Correct irregularities before installing siding.
- Information on installing James Hardie products over non-nailable substrates (ex: gypsum, foam, etc.) can be located in JH Tech Bulletin 19 at [www.jamehardie.com](http://www.jamehardie.com)
- A water-resistive barrier is required in accordance with local building code requirements. The water-resistive barrier must be appropriately installed with penetration and junction flashing in accordance with local building code requirements. James Hardie will assume no responsibility for water infiltration. James Hardie does manufacture HardieWrap® Weather Barrier, a non-woven non-perforated housewrap<sup>1</sup>, which complies with building code requirements.
- Adjacent finished grade must slope away from the building in accordance with local building codes - typically a minimum of 6 in. in the first 10 ft..
- Do not use HardiePlank lap siding in Fascia or Trim applications.
- Do not install James Hardie products, such that they may remain in contact with standing water.
- HardiePlank lap siding may be installed on flat vertical wall applications only.
- For larger projects, including commercial and multi-family projects, where the span of the wall is significant in length, the designer and/or architect should take into consideration the coefficient of thermal expansion and moisture movement of the product in their design. These values can be found in the Technical Bulletin "Expansion Characteristics of James Hardie® Siding Products" at [www.jameshardie.com](http://www.jameshardie.com).
- James Hardie Building Products provides installation /wind load information for buildings with a maximum mean roof height of 85 feet. For information on installations above 60 feet, please contact JH technical support.

## INSTALLATION: JOINT TREATMENT

One or more of the following joint treatment options are required by code (as referenced 2009 IRC R703.10.2)

- Joint Flashing (James Hardie recommended)
- Caulking\* (Caulking is not recommended for ColorPlus for aesthetic reasons as the Caulking and ColorPlus will weather differently. For the same reason, do not caulk nail heads on ColorPlus products.)
- "H" jointer cover



Note: Field painting over caulking may produce a sheen difference when compared to the field painted PrimePlus. \*Refer to Caulking section in these instructions.  
<sup>1</sup>For additional information on HardieWrap® Weather Barrier, consult James Hardie at 1-866-4Hardie or [www.hardiewrap.com](http://www.hardiewrap.com)



SELECT CEDARMILL® | SMOOTH | BEADED CEDARMILL® | BEADED SMOOTH



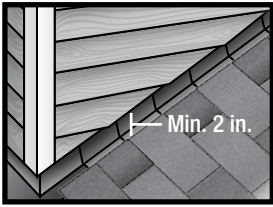
Visit [jameshardiepros.com](http://jameshardiepros.com) for the most recent version.

HS11117 P1/4 09/19

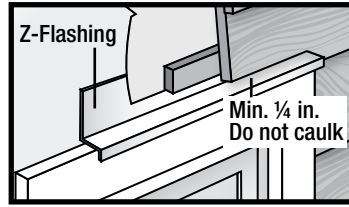


## CLEARANCE AND FLASHING REQUIREMENTS

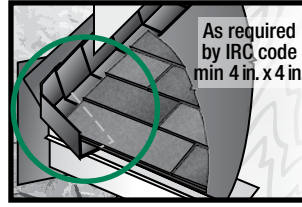
**Figure 3**  
**Roof to Wall**



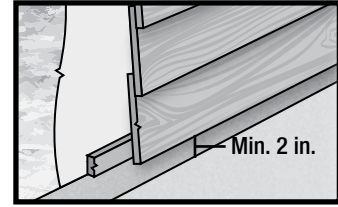
**Figure 4**  
**Horizontal Flashing**



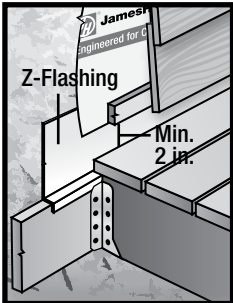
**Figure 5**  
**Kickout Flashing**



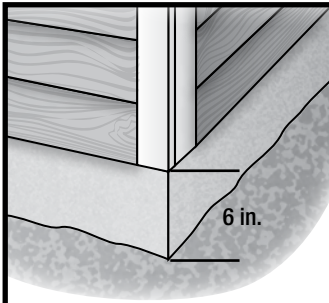
**Figure 6**  
**Slabs, Path, Steps to Siding**



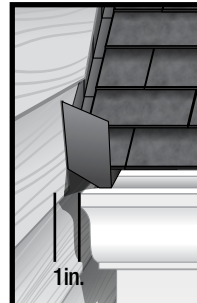
**Figure 7**  
**Deck to Wall**



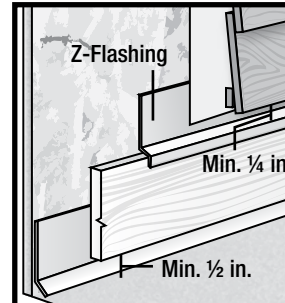
**Figure 8**  
**Ground to Siding**



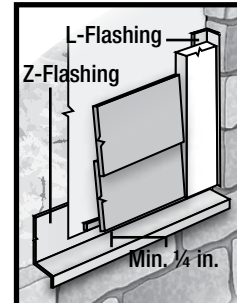
**Figure 9**  
**Gutter to Siding**



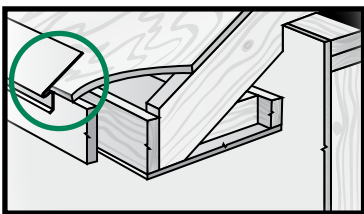
**Figure 10**  
**Sheltered Areas**



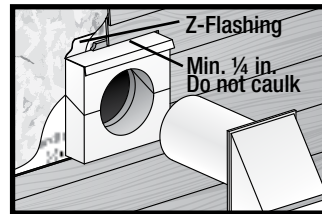
**Figure 11**  
**Mortar/Masonry**



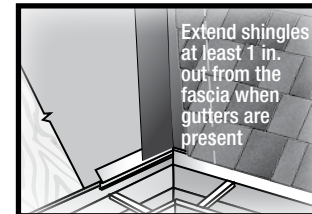
**Figure 12**  
**Drip Edge**



**Figure 13**  
**Block Penetration**



**Figure 14**  
**Valley/Shingle Extension**



## FASTENER REQUIREMENTS\*

Refer to the applicable ESR report online to determine which fastener meets your wind load design criteria.

Blind Nailing is the preferred method of installation for HardiePlank® lap siding products. Face nailing should only be used where required by code for high wind areas and must not be used in conjunction with Blind nailing (Please see JH Tech bulletin 17 for exemption when doing a repair).

### BLIND NAILING

#### Nails - Wood Framing

- Siding nail (0.09 in. shank x 0.221 in. HD x 2 in. long)
- 11ga. roofing nail (0.121 in. shank x 0.371 in. HD x 1.25 in. long)

#### Screws - Steel Framing

- Ribbed Wafer-head or equivalent (No. 8 x 1 1/4 in. long x 0.375 in. HD) Screws must penetrate 3 threads into metal framing.

#### Nails - Steel Framing

- ET & F Panelfast® nails or equivalent (0.10 in. shank x 0.313 in. HD x 1-1/2 in. long) Nails must penetrate minimum 1/4 in. into metal framing.

#### OSB minimum 7/16 in.

- Siding nail (0.09 in. shank x 0.215 in. HD x 1-1/2 in. long)
- Ribbed Wafer-head or equivalent (No. 8 x 1 5/8 in. long x 0.375 in. HD).

### FACE NAILING

#### Nails - Wood Framing

- 6d (0.113 in. shank x 0.267 in. HD x 2 in. long)
- Siding nail (0.09" shank x 0.221" HD x 2" long)

#### Screws - Steel Framing

- Ribbed Bugle-head or equivalent (No. 8-18 x 1-5/8 in. long x 0.323 in. HD) Screws must penetrate 3 threads into metal framing.

#### Nails - Steel Framing

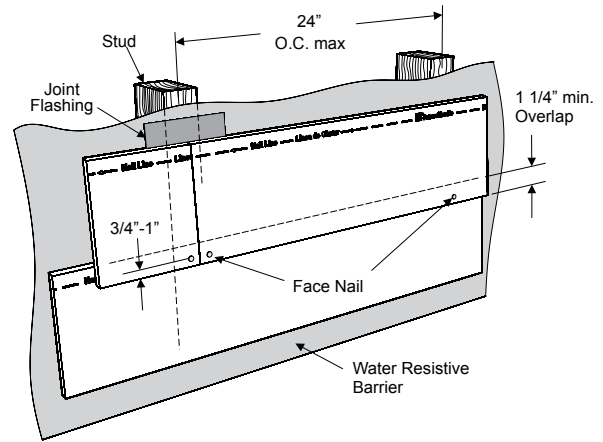
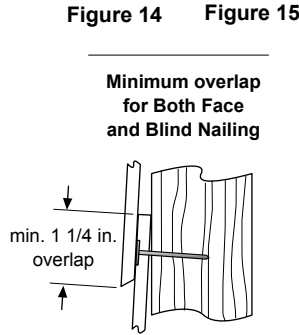
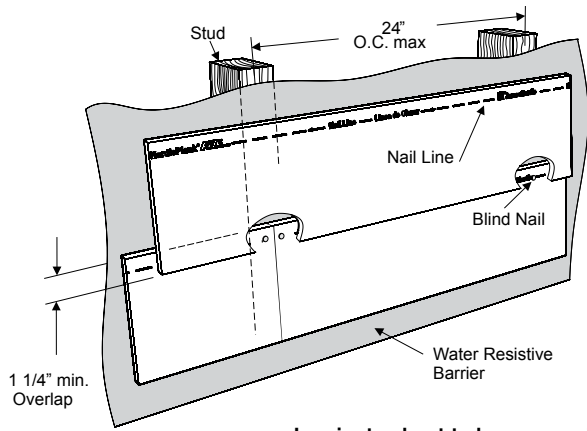
- ET & F pin or equivalent (0.10 in. shank x 0.25 in. HD x 1-1/2 in. long) Nails must penetrate minimum 1/4 in. into metal framing.

#### OSB minimum 7/16 in.

- Siding nail (0.09 in. shank x 0.221 in. HD x 1-1/2 in. long)

\*Also see General Fastening Requirements; and when considering alternative fastening options refer to James Hardie's Technical Bulletin USTB 5 - Fastening Tips for HardiePlank Lap Siding.

**FASTENER REQUIREMENTS** *continued*



Laminate sheet to be removed immediately after installation of each course for ColorPlus® products.

Pin-backed corners may be done for aesthetic purposes only. Finish nails are recommended for pin-backs. Headed siding nails are allowed. Place pin-backs no closer than 1 in. from plank ends and 3/4 in. from plank edge into min. 3/8 in. wood structural panel. Pin-backs are not a substitute for blind or face nailing.

**GENERAL FASTENING REQUIREMENTS**

Fasteners must be corrosion resistant, galvanized, or stainless steel. Electro-galvanized are acceptable but may exhibit premature corrosion. James Hardie recommends the use of quality, hot-dipped galvanized nails. James Hardie is not responsible for the corrosion resistance of fasteners. Stainless steel fasteners are recommended when installing James Hardie® products near the ocean, large bodies of water, or in very humid climates.

Manufacturers of ACQ and CA preservative-treated wood recommend spacer materials or other physical barriers to prevent direct contact of ACQ or CA preservative-treated wood and aluminum products. Fasteners used to attach HardieTrim Tabs to preservative-treated wood shall be of hot dipped zinc-coated galvanized steel or stainless steel and in accordance to 2009 IRC R317.3 or 2009 IBC 2304.9.5

- Consult applicable product evaluation or listing for correct fasteners type and placement to achieve specified design wind loads.
- NOTE: Published wind loads may not be applicable to all areas where Local Building Codes have specific jurisdiction. Consult James Hardie Technical Services if you are unsure of applicable compliance documentation.
- Drive fasteners perpendicular to siding and framing.
- Fastener heads should fit snug against siding (no air space).
- NOTE: Whenever a structural member is present, HardiePlank should be fastened with even spacing to the structural member. The tables allowing direct to OSB or plywood should only be used when traditional framing is not available.

**CUT EDGE TREATMENT**

Caulk, paint or prime all field cut edges. James Hardie touch-up kits are required to touch-up ColorPlus products.

**CAULKING**

For best results use an Elastomeric Joint Sealant complying with ASTM C920 Grade NS, Class 25 or higher or a Latex Joint Sealant complying with ASTM C834. Caulking/Sealant must be applied in accordance with the caulking/sealant manufacturer's written instructions.

**Note: some caulking manufacturers do not allow "tooling".**

**PAINTING**

DO NOT use stain, oil/alkyd base paint, or powder coating on James Hardie® products. Factory-primed James Hardie products must be painted within 180 days of installation. 100% acrylic topcoats are recommended. Do not paint when wet. For application rates refer to paint manufacturers specifications. Back-rolling is recommended if the siding is sprayed.

**PNEUMATIC FASTENING**

James Hardie products can be hand nailed or fastened with a pneumatic tool. Pneumatic fastening is highly recommended. Set air pressure so that the fastener is driven snug with the surface of the siding. A flush mount attachment on the pneumatic tool is recommended. This will help control the depth the nail is driven. If setting the nail depth proves difficult, choose a setting that under drives the nail. (Drive under driven nails snug with a smooth faced hammer - Does not apply for installation to steel framing).

<b>SNUG</b>		<b>FLUSH</b>		
<b>DO NOT UNDER DRIVE</b>		<b>DO NOT OVER DRIVE</b>		<b>DO NOT USE ALUMINUM FASTENERS</b>
<b>DO NOT SLANT</b>				
<p><b>IF, THEN</b></p> <p><b>WOOD FRAME</b></p> <b>HAMMER FLUSH</b>		<p><b>IF, THEN ADDITIONAL NAIL</b></p> <p><b>STEEL FRAME</b></p> <b>REMOVE &amp; REPLACE</b>		<b>DO NOT USE CLIPPED HEAD NAILS</b>
		<p><b>FACE NAIL</b></p> <b>COUNTERSINK &amp; FILL</b>		
				<b>DO NOT USE STAPLES</b>



## COLORPLUS® TECHNOLOGY CAULKING, TOUCH-UP & LAMINATE

- Care should be taken when handling and cutting James Hardie ColorPlus® products. During installation use a wet soft cloth or soft brush to gently wipe off any residue or construction dust left on the product, then rinse with a garden hose.
  - Touch up nicks, scrapes and nail heads using the ColorPlus® Technology touch-up applicator. Touch-up should be used sparingly. If large areas require touch-up, replace the damaged area with new HardiePlank® lap siding with ColorPlus® Technology.
  - Laminate sheet must be removed immediately after installation of each course.
  - Terminate non-factory cut edges into trim where possible, and caulk. Color matched caulks are available from your ColorPlus® product dealer.
  - Treat all other non-factory cut edges using the ColorPlus Technology edge coat, available from your ColorPlus product dealer.
- Note:** James Hardie does not warrant the usage of third party touch-up or paints used as touch-up on James Hardie ColorPlus products.

Problems with appearance or performance arising from use of third party touch-up paints or paints used as touch-up that are not James Hardie touch-up will not be covered under the James Hardie ColorPlus Limited Finish Warranty.

## COVERAGE CHART/ESTIMATING GUIDE

Number of 12 ft. planks, does not include waste

COVERAGE AREA LESS OPENINGS	HARDIEPLANK® LAP SIDING WIDTH									
	SQ (1 SQ = 100 sq.ft.)	5 1/4 4	6 1/4 5	7 1/4 6	7 1/2 6 1/4	8 6 3/4	8 1/4 7	9 1/4 8	9 1/2 8 1/4	12 10 3/4
1		25	20	17	16	15	14	13	13	9
2		50	40	33	32	30	29	25	25	19
3		75	60	50	48	44	43	38	38	28
4		100	80	67	64	59	57	50	50	37
5		125	100	83	80	74	71	63	63	47
6		150	120	100	96	89	86	75	75	56
7		175	140	117	112	104	100	88	88	65
8		200	160	133	128	119	114	100	100	74
9		225	180	150	144	133	129	113	113	84
10		250	200	167	160	148	143	125	125	93
11		275	220	183	176	163	157	138	138	102
12		300	240	200	192	178	171	150	150	112
13		325	260	217	208	193	186	163	163	121
14		350	280	233	224	207	200	175	175	130
15		375	300	250	240	222	214	188	188	140
16		400	320	267	256	237	229	200	200	149
17		425	340	283	272	252	243	213	213	158
18		450	360	300	288	267	257	225	225	167
19		475	380	317	304	281	271	238	238	177
20		500	400	333	320	296	286	250	250	186

This coverage chart is meant as a guide. Actual usage is subject to variables such as building design. James Hardie does not assume responsibility for over or under ordering of product.

## PAINTING JAMES HARDIE® SIDING AND TRIM PRODUCTS WITH COLORPLUS® TECHNOLOGY

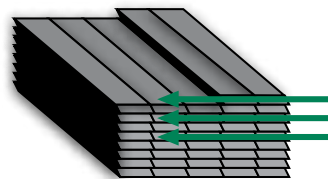
When repainting ColorPlus products, James Hardie recommends the following regarding surface preparation and topcoat application:

- Ensure the surface is clean, dry, and free of any dust, dirt, or mildew
- Repriming is normally not necessary
- 100% acrylic topcoats are recommended
- DO NOT use stain, oil/alkyd base paint, or powder coating on James Hardie® Products.
- Apply finish coat in accordance with paint manufacturers written instructions regarding coverage, application methods, and application temperature
- DO NOT caulk nail heads when using ColorPlus products, refer to the ColorPlus touch-up section

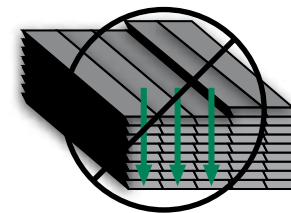
## ADDITIONAL HANDLING REQUIREMENTS

**IMPORTANT:** To prevent damage to the drip edge, extra care should be taken when removing planks from the pallet, while handling, and when installing with a lap gauge. Planks are interlocked together on the pallet, therefore they should be removed from the pallet horizontally (side to side) to allow planks to unlock themselves from one another.

Pull from across the stack



Do not go down the stack



HS11117 P4/4 09/19

**SILICA WARNING**

**DANGER:** May cause cancer if dust from product is inhaled. Causes damage to lungs and respiratory system through prolonged or repeated inhalation of dust from product. Refer to the current product Safety Data Sheet before use. The hazard associated with fiber cement arises from crystalline silica present in the dust generated by activities such as cutting, machining, drilling, routing, sawing, crushing, or otherwise abrading fiber cement, and when cleaning up, disposing of or moving the dust. When doing any of these activities in a manner that generates dust you must (1) comply with the OSHA standard for silica dust and/or other applicable law, (2) follow James Hardie cutting instructions to reduce or limit the release of dust; (3) warn others in the area to avoid breathing the dust; (4) when using mechanical saw or high speed cutting tools, work outdoors and use dust collection equipment; and (5) if no other dust controls are available, wear a dust mask or respirator that meets NIOSH requirements (e.g. N-95 dust mask). During clean-up, use a well maintained vacuum and filter appropriate for capturing fine (respirable) dust or use wet clean-up methods - never dry sweep.

**WARNING:** This product can expose you to chemicals including respirable crystalline silica, which is known to the State of California to cause cancer. For more information go to [P65Warnings.ca.gov](http://P65Warnings.ca.gov).

**RECOGNITION:** In accordance with ICC-ES Evaluation Report ESR-2290, HardiePlank® lap siding is recognized as a suitable alternate to that specified in the 2006, 2009, 2012 & 2015 International Residential Code for One and Two-Family Dwellings, and the 2006, 2009, 2012 & 2015 International Building Code. HardiePlank lap siding is also recognized for application in the following: City of Los Angeles Research Report No. 24862, State of Florida Product Approval FL#13192, Miami-Dade County Florida NOA No. 17-0406.06, U.S. Dept. of HUD Materials Release 1263f, Texas Department of Insurance Product Evaluation EC-23, City of New York MEA 223-93-M, and California DSA PA-019. These documents should also be consulted for additional information concerning the suitability of this product for specific applications.

## HardieShingle® Siding Product Description

HardieShingle® siding is fiber-cement shingle siding for sidewall applications. HardieShingle siding is available as straight-edge panels or staggered-edge panels 48 in. long by 16 in high. HardieShingle panels also come as decorative half-round shingles. For smaller coverage areas, individual shingles are also available in 4.2 in, 5.5 in, 6.75 in, 7.25 in & 10 in widths. Please see your James Hardie dealer for local availability of these products.

HardieShingle siding is available as a prefinished James Hardie product with ColorPlus® Technology. The ColorPlus coating is a factory applied, oven-baked finish available on a variety of James Hardie siding and trim products. See your local dealer for details and availability of products, colors and accessories.



Half-Round



Staggered Edge Panel



Straight Edge Panel



Individual Shingles





# Installation of HardieShingle® Siding

General Product Information

Working Safety

Tools for Cutting and Fastening

General Installation Requirements

General Fastener Requirements

Finishing and Maintenance

HardieWrap® Weather Barrier

HardieTrim® Boards/Battens

HardieSoft® Panels

HardiePlank® Lap Siding

HardieShingle® Siding

HardiePanel® Vertical Siding

Appendix/Glossary

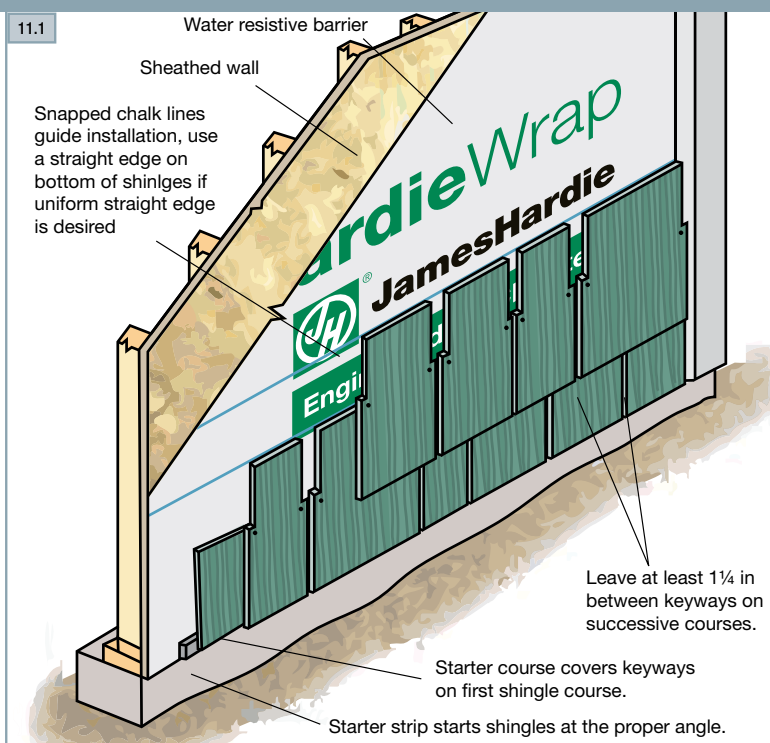
ESR-1844 & 2290 Report

## INDIVIDUAL SHINGLES

Like conventional wood-shingle siding, HardieShingle® siding requires the use of a starter strip and a starter course before installing the first full course of shingle panels or individual shingles. The starter strip sets the initial shingles at the proper angle and the starter course provides solid backing and keyway coverage for the first shingle course.

1. The starter strip should be installed over the water-resistive barrier. Starter strips can be made by ripping 1 ¼ in lengths from full or partial planks of HardiePlank® siding.
2. Use HardiePlank 8 ¼ in lap siding for the starter course.
3. Snap a level chalk line 8 ¼ in up from the bottom edge of the starter strip.
4. Position the top of the starter course along the chalk line, use a straight edge on bottom of shingles if uniform straight edge is desired
5. The first course of shingle siding is then installed even with bottom edge of the starter course.

When installing individual HardieShingles®, be sure to space shingles no more than ¼ in apart. Spaces between shingles should not be within 1 ½ in of the spaces in the courses above and below.



**TIP:** For the best appearance, apply shingle widths in a random manner to avoid creating a repeat pattern. Pre-planning of each course is recommended to aid appearance and to avoid stacked seams.

**TIP:** Stainless steel fasteners are recommended when installing James Hardie products.

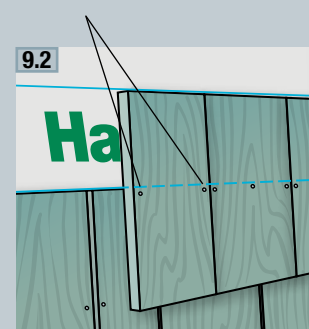
## HARDIESHINGLE SIDING FASTENER SPECIFICATIONS

The Fastener Specifications table shows fastener options for a variety of different nailing substrates. Please refer to the applicable ESR report online (see back page) to determine which fastener meets your wind load design criteria.

Fastening Substrate		Approved Fastener	Fastening Types	
Individual Shingles	Minimum 15/32 in. thick plywood	9	9	roofing nail
	Minimum 7/16 in OSB Sheathing	4	4	siding nail
HardieShingle Panels	16 in or 24 in O.C. wood studs	6	6	ring shank siding nail
	Directly to minimum 7/16 in thick OSB	13	13	ET&F Panelfast
Individual and Shingle Panels	16 in or 24 in O.C. steel studs	13	AGS-100-0150 (.313 in x .100 in x 1.5 in)	
			14	ASM-144-125 (.30 in x .14 in x 1.25 in)
Direct to Masonary		14		

Corrosion-resistant siding nails 1 ¼ in. long should be used to apply individual HardieShingles® to minimum 7/16 in. OSB rated sheathing. Position nails ½ in. to 1 in. from the side edges of the shingles and 8 ½ in. to 9 in up from the bottom edge of the shingle.

2 nails per shingle on 4.2 in., 5.5 in., 6.75 in., 7.25 in., and 10 in. shingles





# Installation of HardieShingle® Siding (cont.)

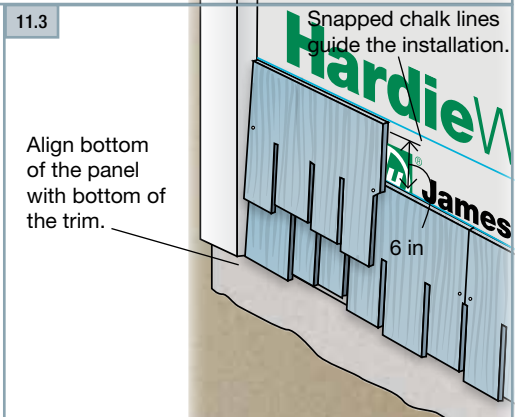
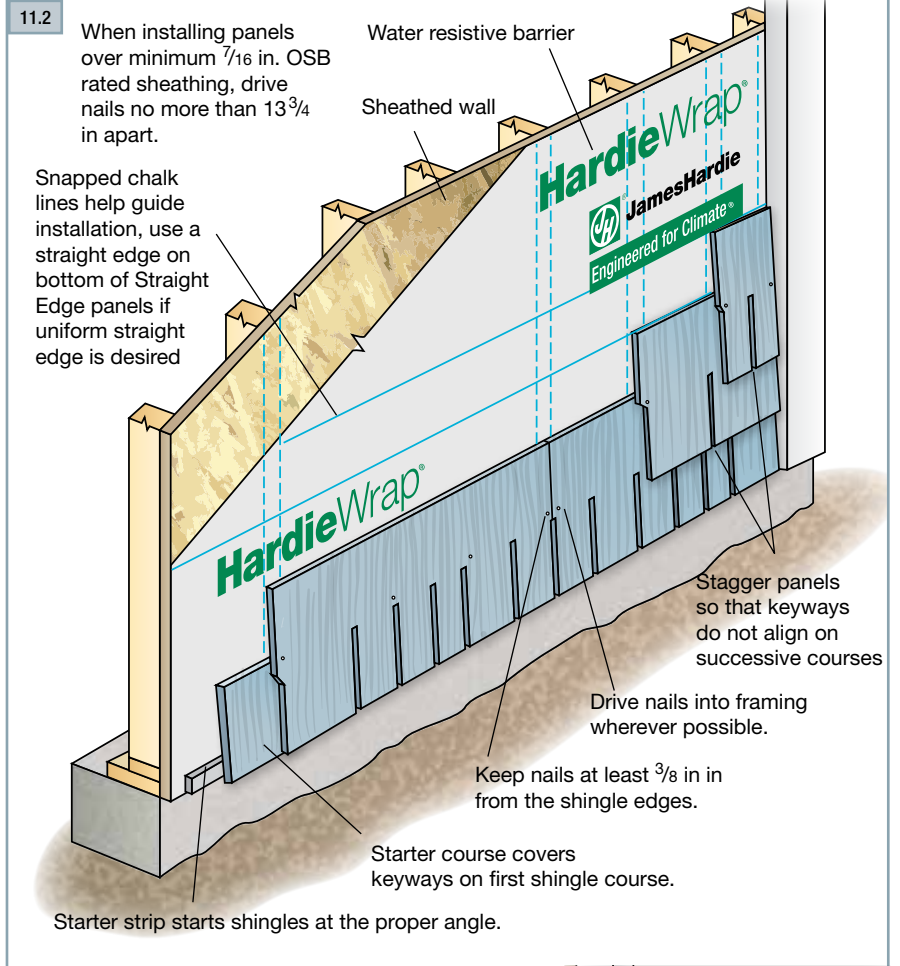
## HARDIESHINGLE® PANELS

For HardieShingle® panels start at one end and work across the wall.

1. Measure and trim the first panel to make sure the end of the panel falls over framing.
2. Using the chalk line as a guide along the panel top edge. For straight edge panels align bottom panel edges to maintain a uniform straight line carefully position the panels and secure with suitable fasteners and spacing for your particular application as noted in the ESR 1844 & 2290 Report.
3. Align the bottom edges of the trim and the siding for the best appearance. Where the panel begins at a corner board or at door or window casings, cut the upper portion of the panel back even with the edge of the keyway.
4. Where the siding meets the HardieTrim® board, leave a 1/8 in. gap between the siding and trim. Install HardieShingle panels with joints in moderate contact.
5. Measure and cut the first panel for the second course of HardieShingle panel so that it lands on the stud before the panel on the first course. Use the cut end to abut the trim.
6. Start the third course with the end of the panel landing on the stud before the second course. Save the cut pieces to use on the other end of the wall.
7. Continue alternating these three lengths up the wall to establish proper positioning of the shingle keyways.

When installing HardieShingle Staggered Edge panel, measure up 6 in. from the top of the installed panel and make a mark. Make another mark at an equal height on the opposite end of the wall and snap a chalk line between the marks. Align the top of the next course of panel with the chalk line to maintain proper exposures.

Keep the bottom of the siding even with the bottom of the trim. If desired, the trim may extend below the bottom of the siding, but the siding should not hang below the trim. Make sure that clearances above the ground, roof lines and hard surfaces are in accordance with the General Requirements on pages 13-26.



**TIP: A straight edge panel can be used on the bottom course if desired**

## WARNING

James Hardie recommends installing HardieShingle panel over rated wood sheathing.

### INSTALLING HARDIESHINGLE® PANEL DIRECT TO 7/16 IN SHEATHING

Refer to ESR-2290 for allowable wind loads.

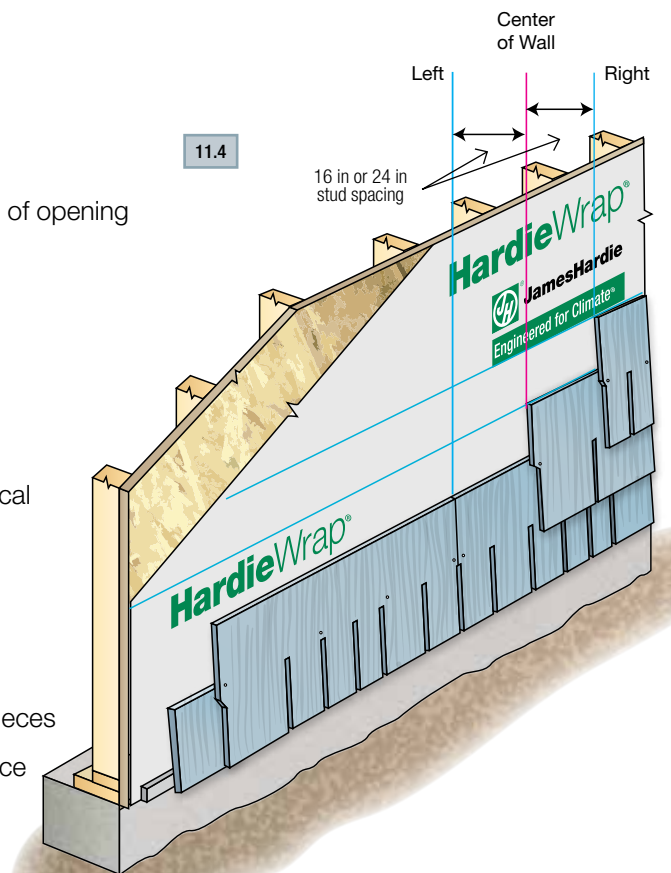
Panel and Individuals may be mixed together to reduce waste and save time.

#### Straight Wall

1. Always work from center of wall to outside corner trim
2. Make all shingle length cuts at trim, not mid wall
3. Start first panel to left of center
4. If openings exist on wall, locate offset layout on each side of opening
5. Start second row of shingle on centerline of offset layout
6. Start third row of shingle on right line of offset layout
7. Repeat starting panel on remaining rows using Left, Middle, Right layout lines

#### Gable

1. Layout offset on gable similar to straight wall, except vertical layout lines should be made across the gable face at the offset dimension
2. Utilize three center lines for starting row
3. Start first piece on the left vertical line, left of center
4. Use the additional vertical lines to pre measure finishing pieces
5. Start Second row on the vertical centerline of the gable face
6. Start third row on vertical line to the right of center
7. Repeat starters Left, Middle, Right for remaining courses



### HALF-ROUND DECORATIVE SHINGLE PANELS

Half-round shingles are often used for a decorative note above regular shingles, especially in gables.

1. Start the first course from the middle of the run so that half round sections at either end are cut equally.
2. Then start the second course from the trim at one end and cut it so that it lands on the framing one stud away from the course below.
3. Cut the panel to abut the trim at the other end of the course. Make sure keyways are located over the midpoints of the half rounds in the lower course for correct alignment.
4. At the top of the wall, install a frieze board and install shingles up to the bottom edge of the frieze.
5. Top rows of shingles may have to be cut to an appropriate height to maintain consistent exposure top to bottom.

All HardieShingle® siding products can be applied to the gable end of a building following their specific installation instructions. But special care should be taken when installing half-round panels due to their symmetrical nature.

# Installation of HardieShingle® Siding (cont.)

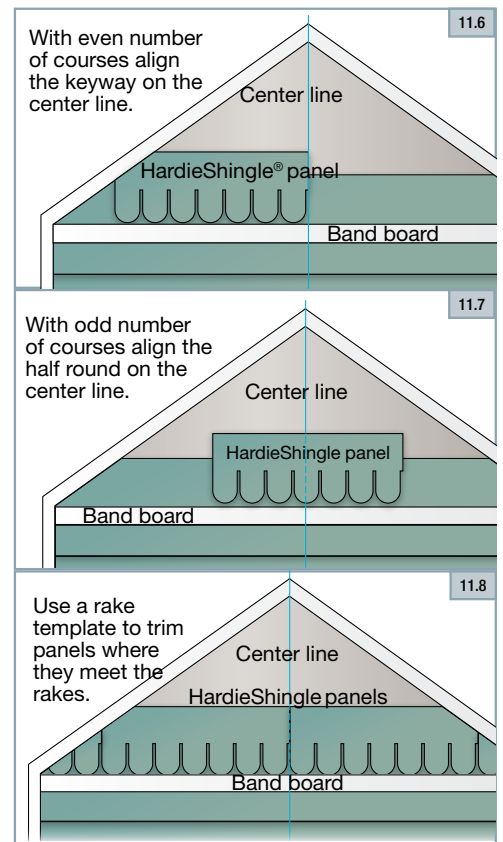
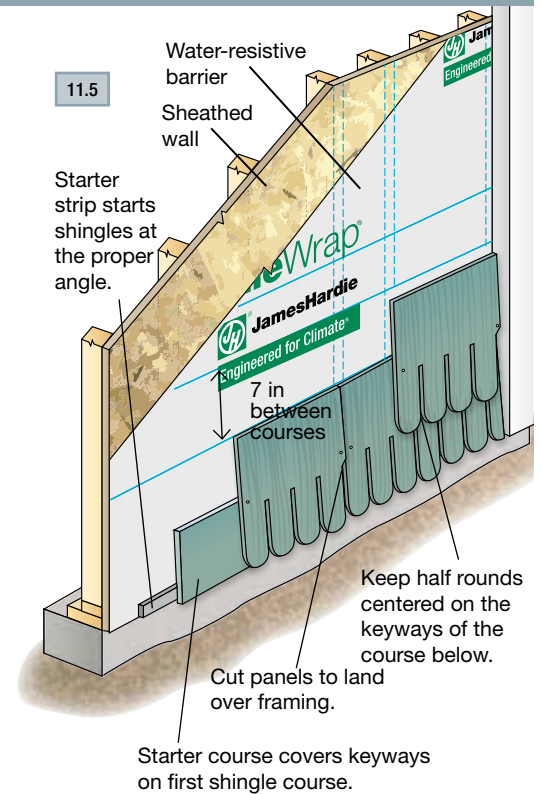
## HALF-ROUND DECORATIVE SHINGLE PANELS (CONTINUED)

For best appearance, half-round shingle panel installations on gable ends should end with a single round shingle at the gable peak. To make this happen, calculation of the actual number of courses is necessary. Follow the simple steps below to achieve this effect.

1. Measure the horizontal width of the gable being sided and locate the center of the gable. Using a level or chalk line, draw a line from the gable peak to the center mark.
2. Measure the entire height of the gable area to be sided above the band board.
3. Divide the total height of the gable by 7. (Half round shingles have an exposure of 7 in and this figure is the number of courses to be installed.)
4. If the answer is an even number (example: 70 in divided by 7 = 10 courses), center the first panel course on a keyway on the vertical center line (fig. 9.7). If the answer is an odd number, (example: 77 in divided by 7 = 11 courses) center the first course on the center of a half-round shingle (fig. 9.8).
- 5.) Using this planning method, the final piece at the peak should be a centered shingle.

### To install the first course of half-round panel in a gable:

1. position the first piece of panel on the gable centerline marked earlier. The panel may be moved left or right to make the edge lands on a stud as long as the shingle face or keyway is centered (depending on the number of courses needed as discussed above).
2. Drive nails approximately 1/4 in. above the top of every other keyway. Avoid driving nails between the keyways because the heads may be visible through the keyways of subsequent courses.
3. Complete the installation on the left and right sides using the rake-angle template to cut the proper rake angle. Leave a 1/8 in. gap between the siding and trim boards.
4. Use the rake angle template to trim back the start panel for the 2nd course. Install the 2nd and following courses the same way. At the peak of the gable, face nail the final piece with a finish nailer.





# HardieShingle® Siding

SINGLE FAMILY INSTALLATION REQUIREMENTS

EFFECTIVE DECEMBER 2019

**IMPORTANT: FAILURE TO FOLLOW JAMES HARDIE WRITTEN INSTALLATION INSTRUCTIONS AND COMPLY WITH APPLICABLE BUILDING CODES MAY VIOLATE LOCAL LAWS, AFFECT BUILDING ENVELOPE PERFORMANCE AND MAY AFFECT WARRANTY COVERAGE. FAILURE TO COMPLY WITH ALL HEALTH AND SAFETY REGULATIONS WHEN CUTTING AND INSTALLING THIS PRODUCT MAY RESULT IN PERSONAL INJURY. BEFORE INSTALLATION, CONFIRM YOU ARE USING THE CORRECT HARDIEZONE® PRODUCT INSTRUCTIONS BY VISITING HARDIEZONE.COM OR CALL 1-866-942-7343 (866-9-HARDIE)**

## STORAGE & HANDLING:

Store flat and keep dry and covered prior to installation. Installing siding wet or saturated may result in shrinkage at butt joints. Carry planks on edge. Protect edges and corners from breakage. James Hardie is not responsible for damage caused by improper storage and handling of the product.



## CUTTING INSTRUCTIONS

### OUTDOORS

1. Position cutting station so that airflow blows dust away from the user and others near the cutting area.
2. Cut using one of the following methods:
  - a. Best: Circular saw equipped with a HardieBlade® saw blade and attached vacuum dust collection system. Shears (manual, pneumatic or electric) may also be used, not recommended for products thicker than 7/16 in.
  - b. Better: Circular saw equipped with a dust collection feature (e.g. Roan® saw) and a HardieBlade saw blade.
  - c. Good: Circular saw equipped with a HardieBlade saw blade.

### INDOORS

DO NOT grind or cut with a power saw indoors. Cut using shears (manual, pneumatic or electric) or the score and snap method, not recommended for products thicker than 7/16 in.

- DO NOT dry sweep dust; use wet dust suppression or vacuum to collect dust.
- For maximum dust reduction, James Hardie recommends using the "Best" cutting practices. Always follow the equipment manufacturer's instructions for proper operation.
- For best performance when cutting with a circular saw, James Hardie recommends using HardieBlade® saw blades.
- Go to jameshardiepros.com for additional cutting and dust control recommendations.

**IMPORTANT:** The Occupational Safety and Health Administration (OSHA) regulates workplace exposure to silica dust. For construction sites, OSHA has deemed that cutting fiber cement with a circular saw having a blade diameter less than 8 inches and connected to a commercially available dust collection system per manufacturer's instructions results in exposures below the OSHA Permissible Exposure Limit (PEL) for respirable crystalline silica, without the need for additional respiratory protection.

If you are unsure about how to comply with OSHA silica dust regulations, consult a qualified industrial hygienist or safety professional, or contact your James Hardie technical sales representative for assistance. James Hardie makes no representation or warranty that adopting a particular cutting practice will assure your compliance with OSHA rules or other applicable laws and safety requirements.

## GENERAL REQUIREMENTS:

- HardieShingle panels can be installed over braced wood or steel studs, 20 gauge (33 mils) minimum to 16 gauge (54 mils) maximum, spaced a maximum of 24 in o.c. or directly to minimum 7/16 in thick OSB sheathing. See General Fastening Requirements. Irregularities in framing and sheathing can mirror through the finished application. Correct irregularities before installing siding.
- Information on installing James Hardie products over non-nailable substrates such as gypsum, foam, etc. can be located in JH Tech Bulletin 19 at [www.jamehardie.com](http://www.jamehardie.com)
- A water-resistive barrier is required in accordance with local building code requirements. The water-resistive barrier must be appropriately installed with penetration and junction flashing in accordance with local building code requirements. James Hardie will assume no responsibility for water infiltration. James Hardie does manufacture HardieWrap® Weather Barrier, a non-woven non-perforated housewrap<sup>1</sup>, which complies with building code requirements.
- When installing James Hardie® products all clearance details in figs. 1 thru 14 must be followed.
- Adjacent finished grade must slope away from the building in accordance with local building codes - typically a minimum of 6 in in the first 10ft.
- Do not install James Hardie products, such that they may remain in contact with standing water.
- HardieShingle panels may be installed on vertical wall applications only.
- DO NOT use stain, oil/alkyd base paint, or powder coating on James Hardie® Products.
- James Hardie Building Products provides installation/wind load information for buildings with a maximum mean roof height of 85 feet. For information on installations above 60 feet, please contact JH technical support.

<sup>1</sup>For additional information on HardieWrap® Weather Barrier, consult James Hardie at 1-866-4Hardie or [www.hardiewrap.com](http://www.hardiewrap.com)



STAGGERED EDGE PANEL | STRAIGHT EDGE PANEL | INDIVIDUAL SHINGLES | HALF-ROUNDS PANELS



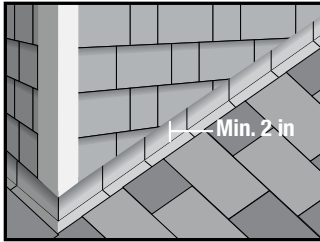
Visit [jameshardiepros.com](http://jameshardiepros.com) for the most recent version.

HS1067 P1/8 12/19

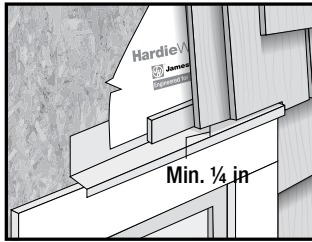


## CLEARANCE AND FLASHING REQUIREMENTS

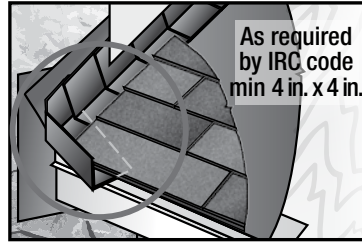
**Figure 1**  
**Roof to Wall**



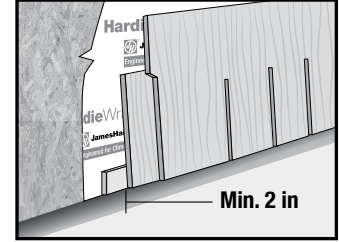
**Figure 2**  
**Horizontal Flashing**



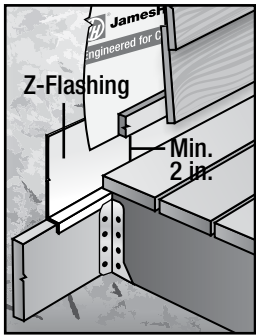
**Figure 3**  
**Kickout Flashing**



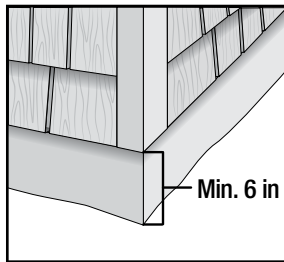
**Figure 4**  
**Slabs, Paths, Steps to Siding**



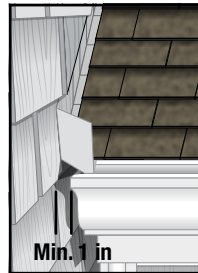
**Figure 7**  
**Deck to Wall**



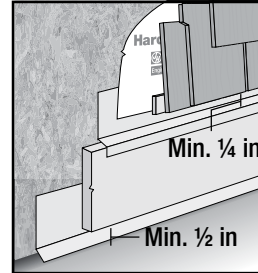
**Figure 8**  
**Ground to Siding**



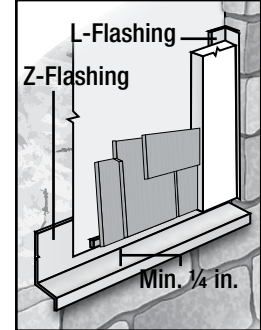
**Figure 9**  
**Gutter to Siding**



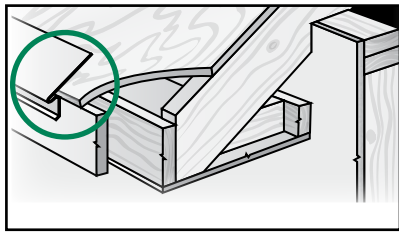
**Figure 10**  
**Sheltered Areas**



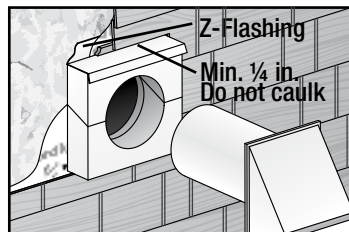
**Figure 11**  
**Mortar/Masonry**



**Figure 12**  
**Drip Edge**



**Figure 13**  
**Block Penetration**



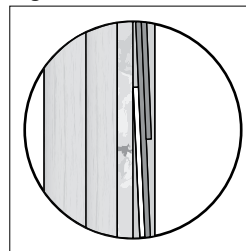
**Figure 14**  
**Valley/Shingle Extension**



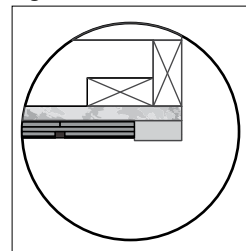
### TRIM CONSIDERATION:

Minimum 1 in trim thickness is needed as Panels stack at a depth of roughly 15/16 in for the 7 in reveal. If additional trim depth is desired, you can place a spacer under the trim (Fig. 15C & 15D).

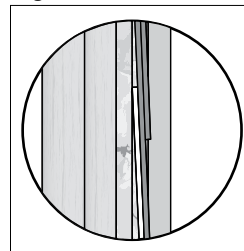
**Figure 15A**



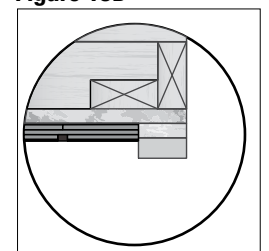
**Figure 15B**



**Figure 15C**



**Figure 15D**





## GABLE INSTALLATION:

Installation over sheathing is recommended (Required for Individuals) for gables.\*

- 1) Find the center stud of your of your Gable and snap a caulk line down
- 2) Measure out 16 in\* to both the left and the right of the center line and snap a caulk line
- 3) Measure up 2 in if you are off a roof line or ¼ in if you are starting above a band board
- 4) Set the bottom of your 1 ¼ in starter strip at that line
- 5) Place your 8 ¼ in Starter Course -bottom level with the bottom of the starter strip
- 6) Set your first row of Shingle - starting the first piece at the vertical line left of center  
(If you are using staggered edged shingles Trim down the first row to the shortest shingle length)
- 7) Drive nails approximately ¼ in above Key ways 5 per full panel Center Nail can be either one of the keyways.  
(Stay by keyway to avoid shiners) (EX1) Blue Dots show nail placement
- 8) Measure up 7 in with straight and 6 in with Staggered edge and snap a caulk line to get your proper exposure
- 9) The second row will start at the center line
- 10) The Third row will start at the line right of center
- 11) As you work your way up the gable make sure you Keep your Cut Pieces you will use the pieces on the edges of the gable (EX2)
- 12) Edges Gable butting into trim leave a 1/8 in Gap (for house movement and Caulking)
- 13) Make sure to sure siding nails on the small pieces on the edges (Do not use a trim nail to install!)

Figure 16

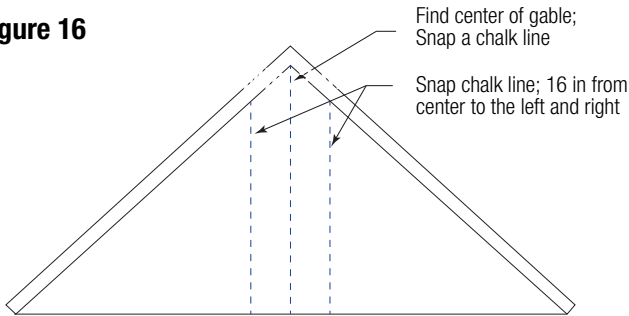


Figure 17

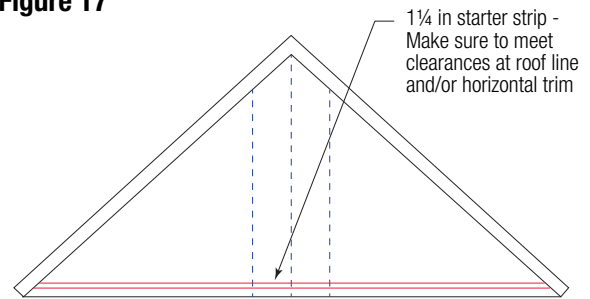


Figure 18

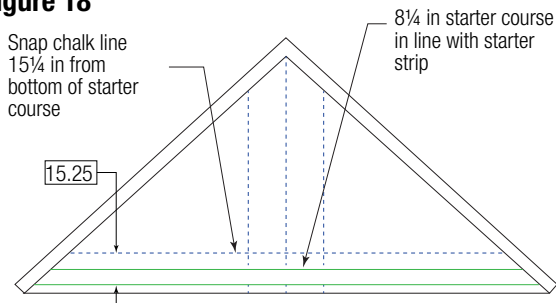


Figure 19

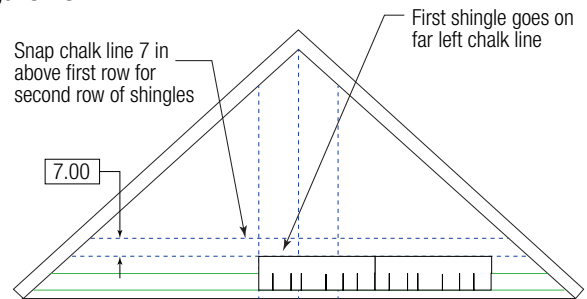


Figure 20

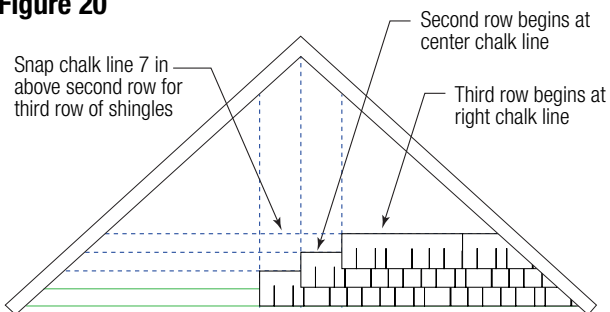
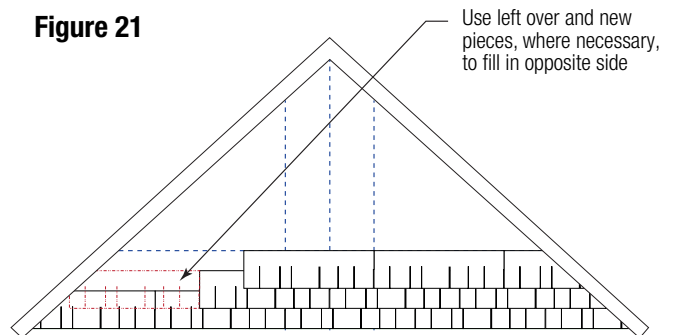


Figure 21



\*Panels can also be installed direct to stud up to 24 in OC.

Note: Snapped chalk lines help guide installation, when installing straight edge panels or Individual shingles use a straight edge on bottom edges if uniform straight edge is desired.



### HARDIESHINGLE STAGGERED EDGE PANELS INSTALLATION

#### Fastener Requirements

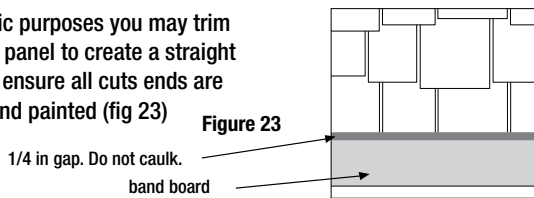
0.083 in x 0.187 in HD x 1 1/2 in long ringshank nails are used for fastening HardieShingle® Staggered Edge Panels to both framing and to 7/16 in thick APA rated sheathing.

#### HardieShingle® Staggered Edge Panel Installation

Install HardieShingle® panels with joints butted in moderate contact. Due to overlapping of the joints, caulk is not required except where panels abut trim boards. (fig. 22 & 24). Ensure keyways do not line up on subsequent courses.

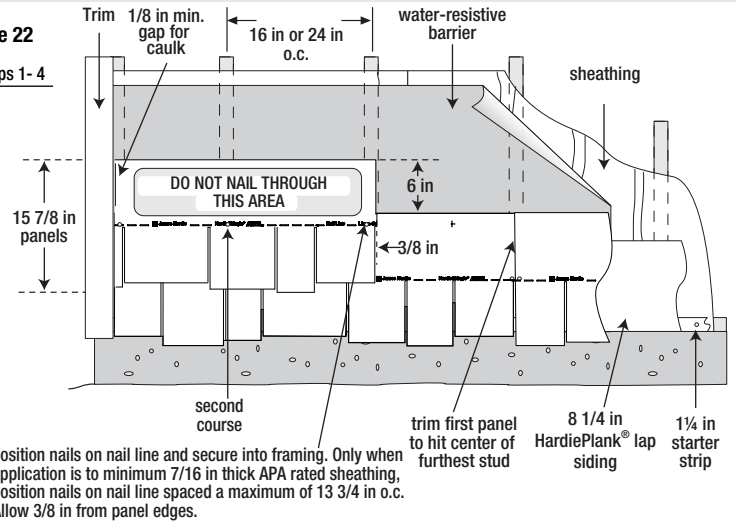
- 1) Install a 1-1/4 in starter strip, then install a 8-1/4 in wide HardiePlank® lap siding starter course.
- 2) Place first panel so that panel end centers over stud. Trim panel as needed. Butt the cut end into trim as shown (figs 22 & 24). When installing over a band board or any horizontal surface, leave 1/4 in gap between bottom of siding and flashing.
- 3) Secure panel, leaving 1/8 in gap for caulk at trim and continue the course along the wall.
- 4) Start the second course, by removing the equivalent of one full stud cavity (16 in or 24 in OC), again abutting the cut end into the trim (figs 22 & 24). This is to prevent pattern repetition. Repeat step 3.
- 5) Start the third course, by removing the equivalent of two full stud cavities (figs 22 & 24) and repeat step 3.
- 6) Continue up the wall repeating steps 2 through 6 until desired height is reached.

**Note: For aesthetic purposes you may trim the bottom of the panel to create a straight edge. If doing so, ensure all cuts ends are properly sealed and painted (fig 23)**

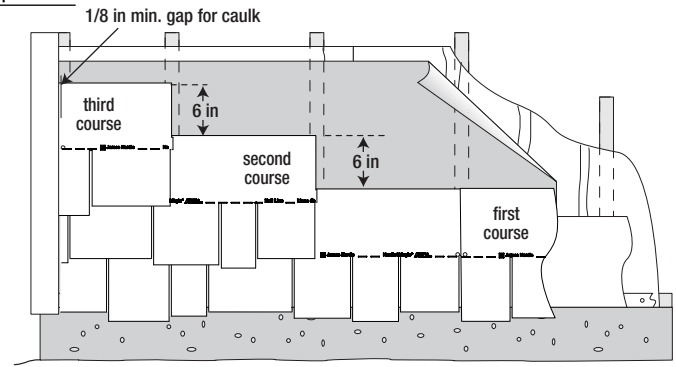


**Figure 22**

Steps 1 - 4



Steps 5 & 6



### HARDIESHINGLE STAGGERED EDGE PANEL COVERAGE

Panels for sidewall applications are available in 48 in lengths. Pieces needed for one square (100sq.ft.) of product coverage = approximately 50, based on a maximum 6 in exposure from the top edge of HardieShingle panels in subsequent courses (refer to Figure 22).

### 7 IN EXPOSURE HARDIESHINGLE STRAIGHT EDGE PANELS INSTALLATION (For 5 in exposure product please go to page 7)

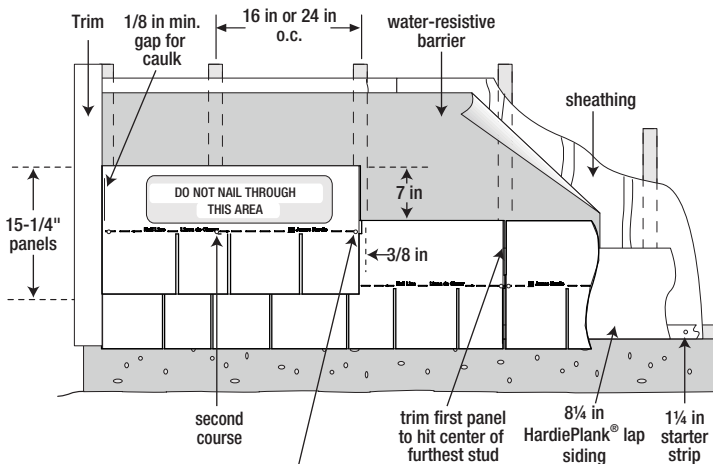
Maximum Exposure of 7 in

REFER TO STAGGERED EDGE INSTRUCTIONS ABOVE

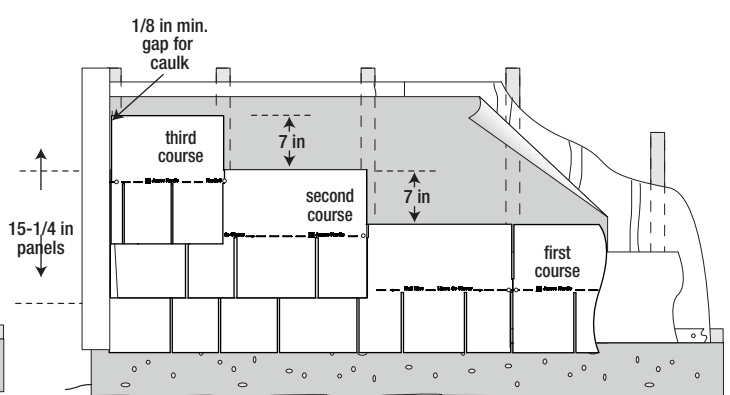
Steps 1 - 4

**Figure 24**

Steps 5 & 6



position nails on nail line and secure into framing. Only when application is to minimum 7/16 in thick APA rated sheathing, position nails on nail line spaced a maximum of 13 3/4 in o.c. Allow 3/8 in from panel edges.



### HARDIESHINGLE STRAIGHT EDGE PANEL COVERAGE

Panels for sidewall applications are available in 48 in lengths. Pieces needed for one square (100sq.ft.) of product coverage = approximately 43, based on maximum 7 in exposure.



## HARDIESHINGLE INDIVIDUAL SHINGLE INSTALLATION

HardieShingle Individual Shingles must be installed with the widest part of the shingle placed downwards and directly to minimum 7/16 in thick sheathing.

### Fastener Requirements

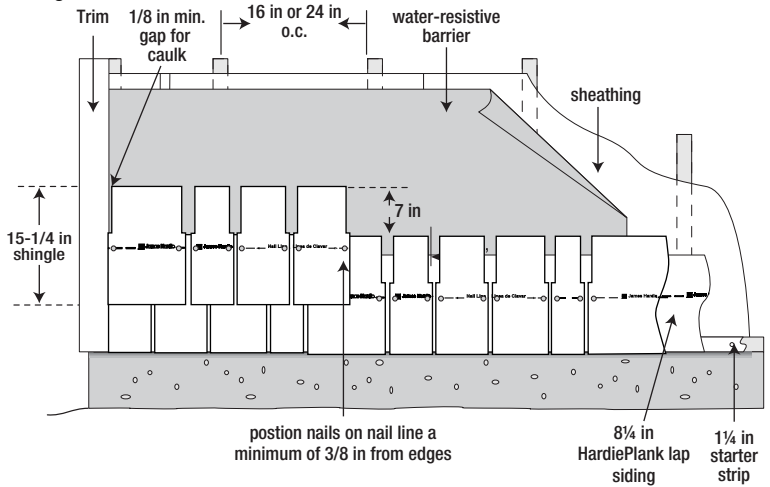
0.091 in x 0.221 in HD x 1 1/2 in or 0.121 in x 0.371 in HD x 1 1/4 in long corrosion resistant siding nails are used for fixing HardieShingle siding to 7/16 in thick APA rated sheathing.

### HardieShingle Individual Shingle Installation

Due to overlapping of the joints, caulk is not required except where panels butt trim boards. Space shingles a maximum 1/4 in apart and leave a minimum lap of 1 1/2 in between successive courses (fig. 26).

- 1) Install 1 1/4 in starter strip and a 8 1/4 in wide HardiePlank siding starter course.
- 2) Install first shingle from the end abutting trim. Install widest part of shingle placed downwards. (fig. 25).
- 3) Secure shingle, leaving a 1/8 in gap for caulk at trim and continue the course along the wall.
- 4) Start the second course, leaving a minimum lap of 1 1/2 in between successive courses, again from the end abutting the trim. Repeat step 3.
- 5) Continue up the wall repeating steps 2 through 5 until desired height is reached.

Figure 25

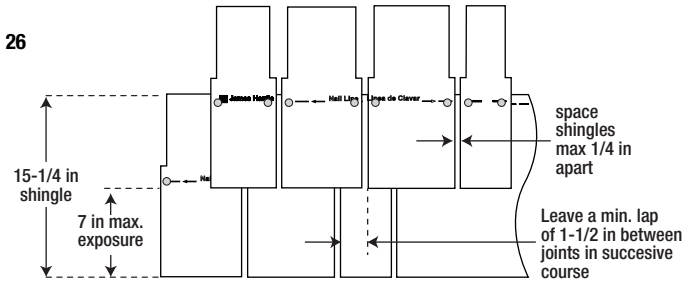


## HARDIESHINGLE INDIVIDUAL SHINGLE COVERAGE

Individual Shingles for sidewall applications are available in assorted widths as listed below. Bundles needed for one square (100 sq. ft.) of product coverage:

Shingle Width	Number of Bundles	Pieces per Bundle
4-3/16 in	3	15
5-1/2 in	6	15
6-3/4 in	3	15
7-1/4 in	6	15
10 in	3	15

Figure 26



**! Install with the widest part of the shingle placed downwards**

## HARDIESHINGLE HALF-ROUND PANELS INSTALLATION

### Fastener Requirements

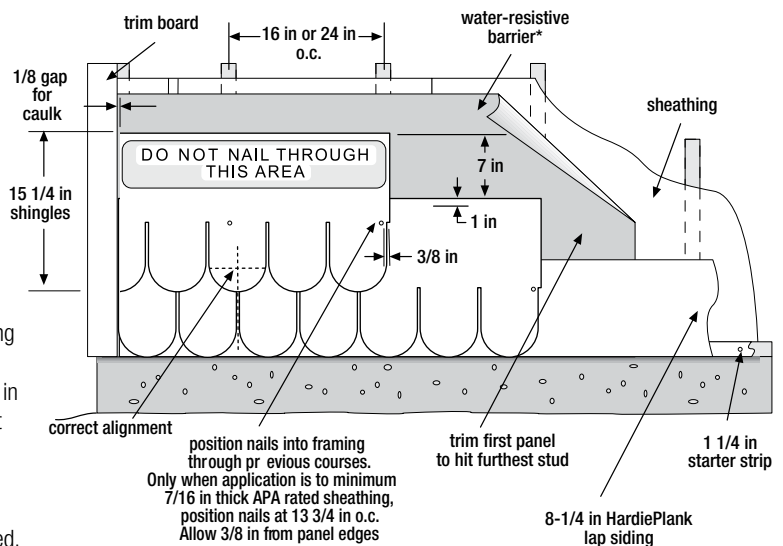
0.083 in x 0.187 in HD x 1 1/2 in long ringshank nails are used for fastening HardieShingle Half-Round Panels to both framing and to 7/16 in thick APA rated sheathing.

### HardieShingle Half-Round Panel Installation

Install HardieShingle panels with joints butted in moderate contact. Due to overlapping of the joints, caulk is not required except where panels abut trim boards. (fig. 27). Ensure keyways do not line up on subsequent courses.

- 1) Install a 1-1/4 in starter strip, then install a 8-1/4 in wide HardiePlank lap siding starter course.
- 2) Place first panel so that panel end centers over stud. Trim panel as needed. Butt the cut end into trim as shown (figs 27). When installing over a band board or any horizontal surface, leave 1/4 in gap between bottom of siding and flashing.
- 3) Secure panel, leaving 1/8 in gap for caulk at trim and continue the course along the wall.
- 4) Start the second course, by removing the equivalent of one full stud cavity (16 in or 24 in OC), again abutting the cut end into the trim (fig 27). This is to prevent pattern repetition. Repeat step 3.
- 5) Start the third course, by removing the equivalent of two full stud cavities (figs 28 & 30) and repeat step 3.
- 6) Continue up the wall repeating steps 2 through 6 until desired height is reached.

Figure 27



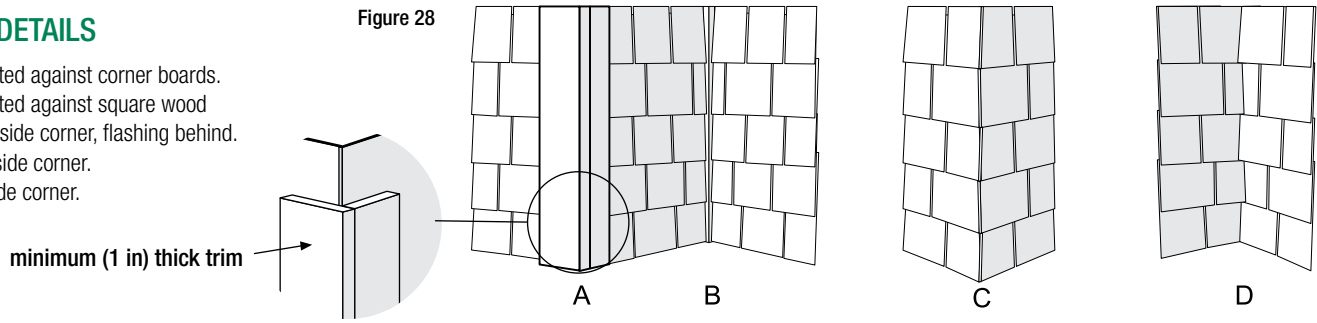
## HARDIESHINGLE HALF-ROUND PANEL COVERAGE

Panels for sidewall applications are available in 48 in lengths. Pieces needed for one square (100 sq. ft.) of product coverage=43 pieces with 7 in exposure.



### CORNER DETAILS

- A. Panels butted against corner boards.
- B. Panels butted against square wood strip on inside corner, flashing behind.
- C. Laced outside corner.
- D. Laced inside corner.



### WINDOWS AND DOORS

Building wall components such as windows, doors and other exterior wall penetrations shall be installed in accordance with the component manufacturer's written installation instructions and local building codes. Where windows or doors are installed, continue the application of siding as if the wall is complete. Trimming for the opening and using the resulting piece may throw off the spacing above the break.

### GENERAL FASTENING REQUIREMENTS

Refer to the applicable ESR report online to determine which fastener meets your wind load design criteria. Fasteners must be corrosion resistant, galvanized, or stainless steel. Electro-galvanized are acceptable but may exhibit premature corrosion. James Hardie recommends the use of quality, hot-dipped galvanized nails. James Hardie is not responsible for the corrosion resistance of fasteners. Stainless steel fasteners are recommended when installing James Hardie® products near the ocean, large bodies of water, or in very humid climates.

Manufacturers of ACQ and CA preservative-treated wood recommend spacer materials or other physical barriers to prevent direct contact of ACQ or CA preservative-treated wood and aluminum products. Fasteners used to attach HardieTrim Tabs to preservative-treated wood shall be of hot dipped zinc-coated galvanized steel or stainless steel and in accordance to 2009 IRC R317.3 or 2009 IBC 2304.9.5

- Consult applicable product evaluation or listing for correct fasteners type and placement to achieve specified design wind loads.
- NOTE: Published wind loads may not be applicable to all areas where Local Building Codes have specific jurisdiction. Consult James Hardie Technical Services if you are unsure of applicable compliance documentation.
- Drive fasteners perpendicular to siding and framing.
- Fastener heads should fit snug against siding (no air space).
- NOTE: Whenever a structural member is present, HardiePlank should be fastened with even spacing to the structural member. The tables allowing direct to OSB or plywood should only be used when traditional framing is not available.

### PNEUMATIC FASTENING

James Hardie products can be hand nailed or fastened with a pneumatic tool. Pneumatic fastening is highly recommended. Set air pressure so that the fastener is driven snug with the surface of the siding. A flush mount attachment on the pneumatic tool is recommended. This will help control the depth the nail is driven. If setting the nail depth proves difficult, choose a setting that under drives the nail. (Drive under driven nails snug with a smooth faced hammer - Does not apply for installation to steel framing).

<p>SNUG      FLUSH</p>	<p><b>DO NOT</b></p> <p><b>UNDER DRIVE</b></p> <p><b>IF, THEN</b></p> <table border="0"> <tr> <td> <p><b>WOOD FRAME</b></p> <p>HAMMER FLUSH</p> </td> <td> <p><b>STEEL FRAME</b></p> <p>REMOVE &amp; REPLACE</p> </td> </tr> </table>	<p><b>WOOD FRAME</b></p> <p>HAMMER FLUSH</p>	<p><b>STEEL FRAME</b></p> <p>REMOVE &amp; REPLACE</p>	<p><b>DO NOT</b></p> <p><b>OVER DRIVE      SLANT</b></p> <p><b>IF, THEN ADDITIONAL NAIL</b></p> <p><b>FACE NAIL</b></p> <p>COUNTERSINK &amp; FILL</p>	<p><b>DO NOT USE</b></p> <p><b>ALUMINUM FASTENERS</b></p> <p><b>CLIPPED HEAD NAILS</b></p> <p><b>STAPLES</b></p>
<p><b>WOOD FRAME</b></p> <p>HAMMER FLUSH</p>	<p><b>STEEL FRAME</b></p> <p>REMOVE &amp; REPLACE</p>				



### CUT EDGE TREATMENT

Caulk, paint or prime all field cut edges. James Hardie touch-up kits are required to touch-up ColorPlus products.

### CAULKING

For best results use an Elastomeric Joint Sealant complying with ASTM C920 Grade NS, Class 25 or higher or a Latex Joint Sealant complying with ASTM C834. Caulking/Sealant must be applied in accordance with the caulking/sealant manufacturer's written instructions.

**Note: some caulking manufacturers do not allow "tooling".**

### COLORPLUS® TECHNOLOGY CAULKING, TOUCH-UP & LAMINATE

- Care should be taken when handling and cutting James Hardie® ColorPlus® products. During installation use a wet soft cloth or soft brush to gently wipe off any residue or construction dust left on the product, then rinse with a garden hose.
- Touch up nicks, scrapes and nail heads using the ColorPlus® Technology touch-up applicator. Touch-up should be used sparingly. If large areas require touch-up, replace the damaged area with new HardiePlank® lap siding with ColorPlus® Technology.
- Laminate sheet must be removed immediately after installation of each course.
- Terminate non-factory cut edges into trim where possible, and caulk. Color matched caulks are available from your ColorPlus® product dealer.
- Treat all other non-factory cut edges using the ColorPlus Technology edge coaters, available from your ColorPlus product dealer.

**Note:** James Hardie does not warrant the usage of third party touch-up or paints used as touch-up on James Hardie ColorPlus products.

Problems with appearance or performance arising from use of third party touch-up paints or paints used as touch-up that are not James Hardie touch-up will not be covered under the James Hardie ColorPlus Limited Finish Warranty.

### PAINTING JAMES HARDIE® SIDING AND TRIM PRODUCTS WITH COLORPLUS® TECHNOLOGY

When repainting ColorPlus products, James Hardie recommends the following regarding surface preparation and topcoat application:

- Ensure the surface is clean, dry, and free of any dust, dirt, or mildew
- Repriming is normally not necessary
- 100% acrylic topcoats are recommended
- DO NOT use stain, oil/alkyd base paint, or powder coating on James Hardie® Products.
- Apply finish coat in accordance with paint manufacturers written instructions regarding coverage, application methods, and application temperature
- DO NOT caulk nail heads when using ColorPlus products, refer to the ColorPlus touch-up section

### 5 IN EXPOSURE HARDIESHINGLE® STRAIGHT EDGE PANELS INSTALLATION (For 7 in exposure product please go to page 4)

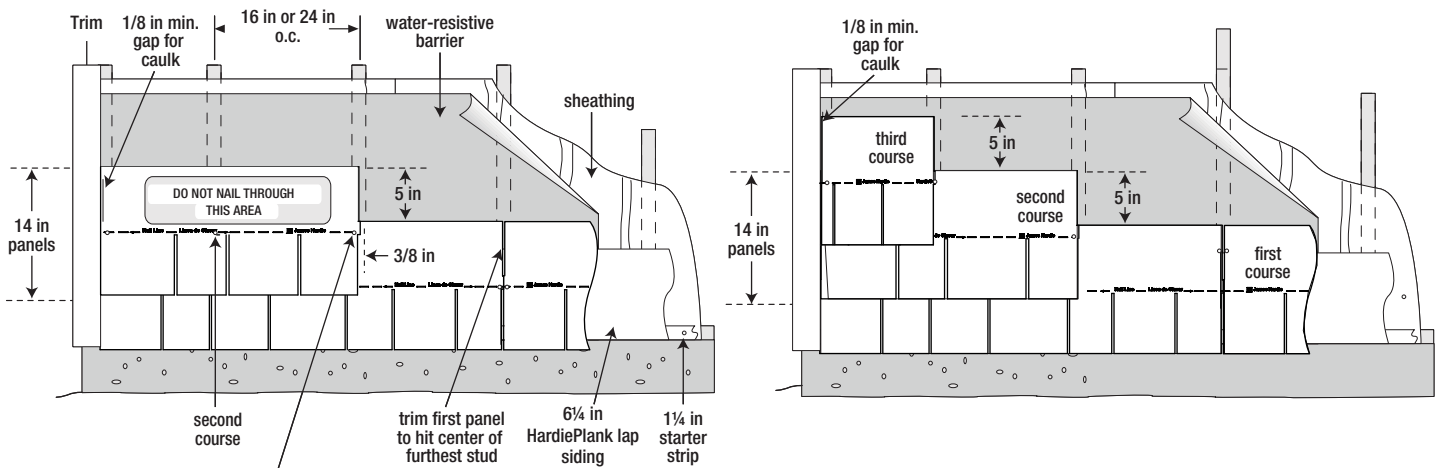
Maximum Exposure of 5 in

REFER TO STAGGERED EDGE INSTRUCTIONS ON PAGE 3

Steps 1 - 4

Figure 29

Steps 5 & 6



position nails on nail line and secure into framing. Only when application is to minimum 7/16 in thick APA rated sheathing, position nails on nail line spaced a maximum of 13 3/4 in o.c. Allow 3/8 in from

### HARDIESHINGLE® STRAIGHT EDGE PANEL COVERAGE

Panels for sidewall applications are available in 48 in lengths. Pieces needed for one square (100sq.ft.) of product coverage = approximately 60, based on maximum 5 in exposure.





## HARDIESHINGLE® INDIVIDUAL SHINGLE INSTALLATION

HardieShingle Individual Shingles must be installed with the widest part of the shingle placed downwards and directly to minimum 7/16 in thick sheathing.

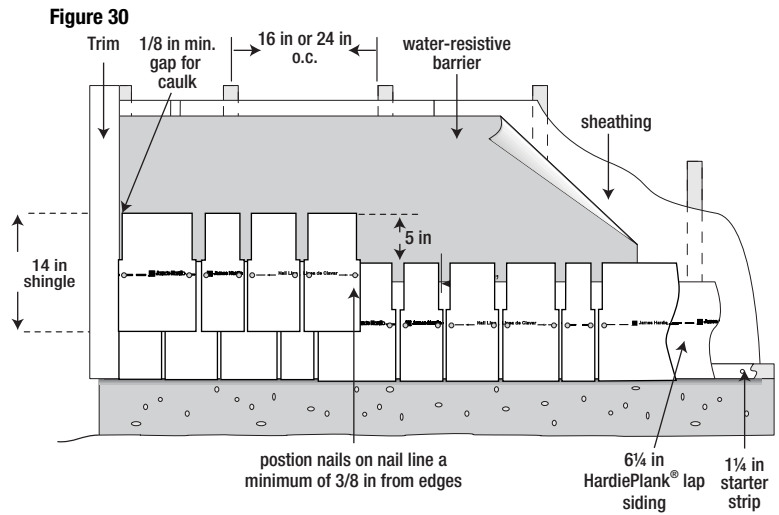
### Fastener Requirements

0.091 in x 0.221 in HD x 1 1/2 in or 0.121 in x 0.371 in HD x 1 1/4 in long corrosion resistant siding nails are used for fixing HardieShingle siding to 7/16 in thick APA rated sheathing.

### HardieShingle Individual Shingle Installation

Due to overlapping of the joints, caulk is not required except where panels butt trim boards. Space shingles a maximum 1/4 in apart and leave a min. lap of 1 1/2 in between successive courses (fig. 31).

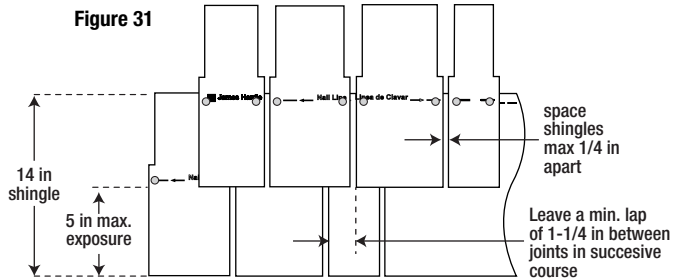
- 1) Install 1 1/4 in starter strip and a 6 1/4 in wide HardiePlank siding starter course.
- 2) Install first shingle from the end abutting trim. Install widest part of shingle placed downwards. (fig. 30).
- 3) Secure shingle, leaving a 1/8 in gap for caulk at trim and continue the course along the wall.
- 4) Start the second course, leaving a minimum lap of 1 1/2 in between successive courses, again from the end abutting the trim. Repeat step 3.
- 5) Continue up the wall repeating steps 2 through 5 until desired height is reached.



## 5 IN EXPOSURE HARDIESHINGLE® INDIVIDUAL SHINGLE COVERAGE

Individual Shingles for sidewall applications are available in assorted widths as listed below. Bundles needed for one square (100 sq. ft.) of product coverage:

Shingle Width	Number of Bundles	Pieces per Bundle
3-1/2 in	3	20
4-1/2 in	6	20
5-1/2 in	6	20
7 in	6	20
8-3/4 in	3	20



**!** Install with the widest part of the shingle placed downwards

HS1067 P8/8 12/19

### SILICA WARNING

**DANGER:** May cause cancer if dust from product is inhaled. Causes damage to lungs and respiratory system through prolonged or repeated inhalation of dust from product. Refer to the current product Safety Data Sheet before use. The hazard associated with fiber cement arises from crystalline silica present in the dust generated by activities such as cutting, machining, drilling, routing, sawing, crushing, or otherwise abrading fiber cement, and when cleaning up, disposing of or moving the dust. When doing any of these activities in a manner that generates dust you must (1) comply with the OSHA standard for silica dust and/or other applicable law, (2) follow James Hardie cutting instructions to reduce or limit the release of dust; (3) warn others in the area to avoid breathing the dust; (4) when using mechanical saw or high speed cutting tools, work outdoors and use dust collection equipment; and (5) if no other dust controls are available, wear a dust mask or respirator that meets NIOSH requirements (e.g. N-95 dust mask). During clean-up, use a well maintained vacuum and filter appropriate for capturing fine (respirable) dust or use wet clean-up methods - never dry sweep.

**! WARNING:** This product can expose you to chemicals including respirable crystalline silica, which is known to the State of California to cause cancer. For more information go to [P65Warnings.ca.gov](http://P65Warnings.ca.gov).

**RECOGNITION:** In accordance with ICC-ES Evaluation Report ESR-2290, HardieShingle® lap siding is recognized as a suitable alternate to that specified in the 2006, 2009, 2012 & 2015 International Residential Code for One and Two-Family Dwellings, and the 2006, 2009, 2012 & 2015 International Building Code. HardieShingle lap siding is also recognized for application in the following: City of Los Angeles Research Report No. 24862, State of Florida Product Approval FL#13192, U.S. Dept. of HUD Materials Release 1263f, Texas Department of Insurance Product Evaluation EC-23. These documents should also be consulted for additional information concerning the suitability of this product for specific applications.

## HardiePanel® Vertical Siding Product Description

HardiePanel® vertical siding is factory-primed fiber-cement vertical siding available in a variety of sizes and textures. Examples of these are shown below. Textures include smooth, stucco, Cedarmill® and Sierra 8. HardiePanel vertical siding is 5/16 in. thick and is available in 4x8, 4x9 and 4x10 sizes. Please see your local James Hardie dealer for texture and size availability.

HardiePanel vertical siding is available as a prefinished James Hardie® product with ColorPlus® Technology. The ColorPlus coating is a factory applied, oven baked finish available on a variety of James Hardie siding and trim products. See your local dealer for availability of products, color and accessories.



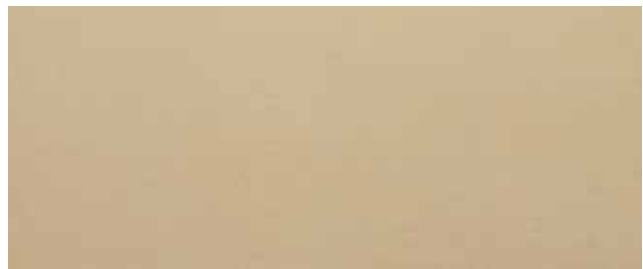
Stucco



Cedarmill®



Sierra 8



Smooth



# Installation of HardiePanel® Vertical Siding

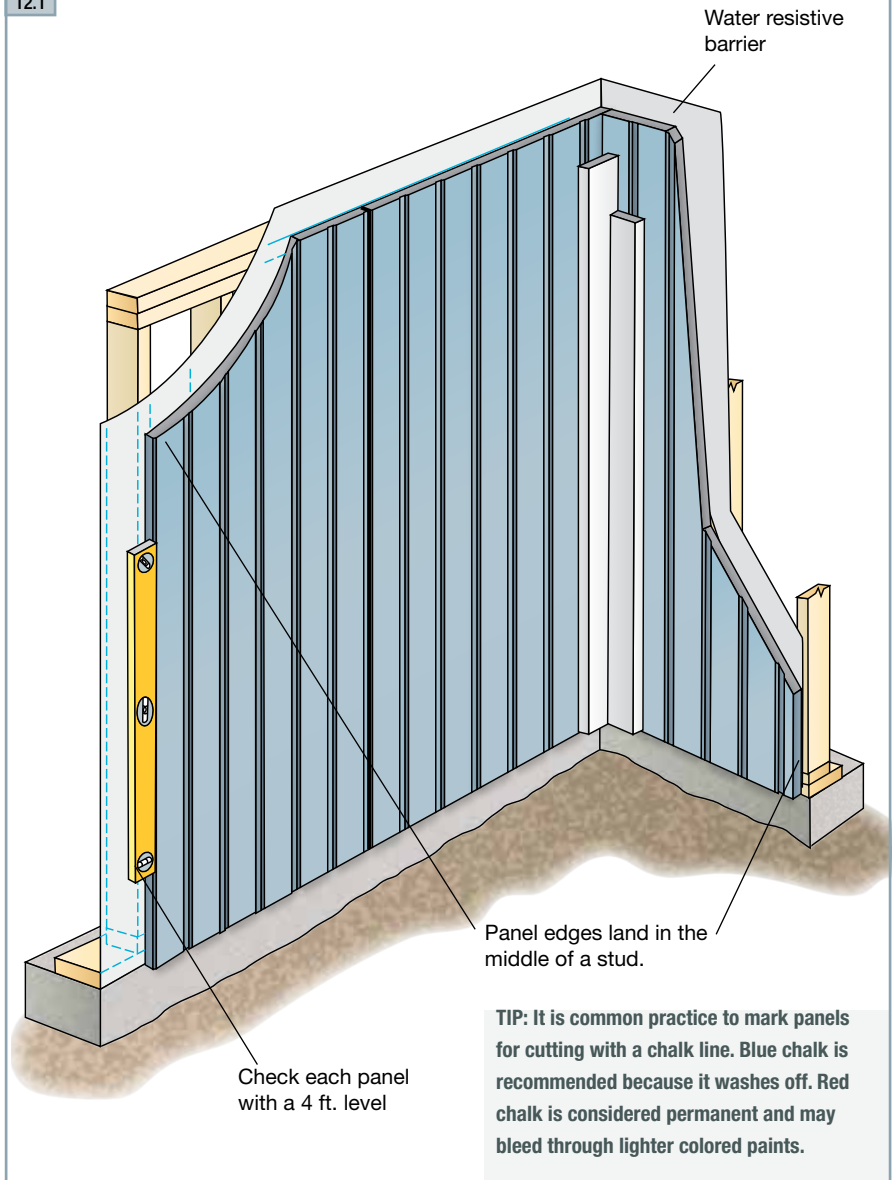
**Note:** James Hardie has a capillary break requirement when installing HardiePanel on a Multi-Family/Commercial project. Please visit: [www.jameshardiepros.com](http://www.jameshardiepros.com) for further information.

## GETTING STARTED

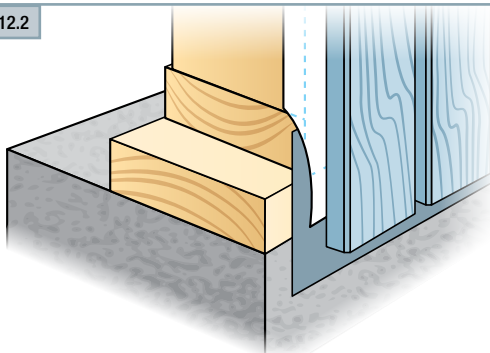
First locate the lowest point of the sheathing or sill plate, and begin installation on that wall.

1. Measure up from the sill plate the height of the panels at either end of the wall and snap a straight, level chalk line between the marks as a reference line. That line is for guidance in positioning the top edge of the panels. Check the reference line with a 4 ft. level.
2. Starting on one end and working across the wall, measure and trim the first panel making sure that the edge falls in the middle of a stud.
3. Using the chalk line as a guide along the panel's top edge, carefully position the panel and secure it with suitable fasteners and fastener spacing for the particular application as noted in the ESR-1844.
4. As installation continues, check the vertical edge of each panel with a 4 ft. level.

12.1

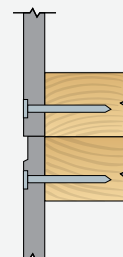


12.2



**TIP:** Install flashing over the footing/foundation and extend the panel over the flashing just below the sill plate. Do not extend siding beyond the required grade clearances.

**TIP:** For Sierra 8 panels, double studs at each panel joint allows fasteners to be placed outside of panel grooves.



## VERTICAL JOINT TREATMENT

Treat vertical joints in HardiePanel® vertical siding by using one of the following four methods:

1. Install the panels in moderate contact.
2. Leave an appropriate gap between panels (1/8 in. is the most common), and caulk using a high-quality paintable caulk, that meets ASTM C-834 or C-920 requirements. (Not recommended for ColorPlus)

Panels may be installed first with caulk applied in the joints after installation; or as an option, after the first panel is installed, apply a bead of caulk along the panel edge. When the next panel is installed against the first, the edge embeds in the applied caulk creating a thorough seal between the edges of the panels.

**! WARNING**

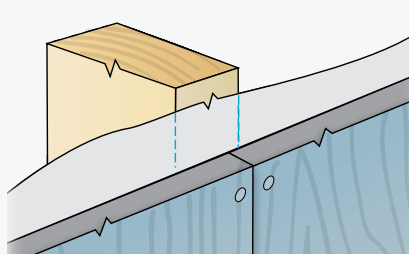
The caulk joint method is not recommended for the ColorPlus® products

3. Vertical joints may be covered with wood or fiber-cement batten strips. If James Hardie® siding or trim products are ripped and used as batten strips, paint or prime the cut edges. Batten strips should span the vertical joint by at least 3/4 in. on each side.
4. Metal or PVC "H" moldings can be used to join two sections of HardiePanel siding.

**TIP:** Stainless steel fasteners are recommended when installing James Hardie products.

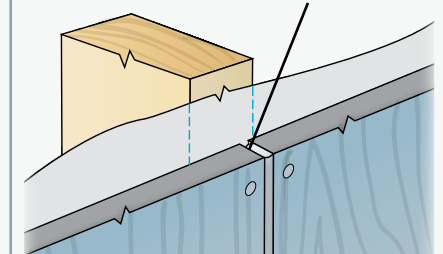
**12.3 1 Moderate contact joint**

Panels are butted together lightly.



**12.4 2 Caulked joint**

1/8 in. gap left between panels is filled with caulk. (not applicable with ColorPlus)

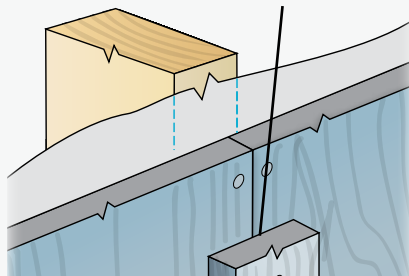


**Note: The following outlines the recommended applications for ColorPlus and Primed panels. Not all designs will be suitable for every application:**

- Exposed fasteners or battens is the recommended application for ColorPlus products
- Do not use touch-up over fastener heads for smooth ColorPlus products - primed panel recommended
- For ColorPlus panel applications that require fasteners in the field, it is acceptable to use touch-up over fasteners for Cedarmill and Stucco panel only, but correct touch-up application is important. Some colors may show touch-up when applied over fasteners. Trim is recommended to cover joints when appropriate.

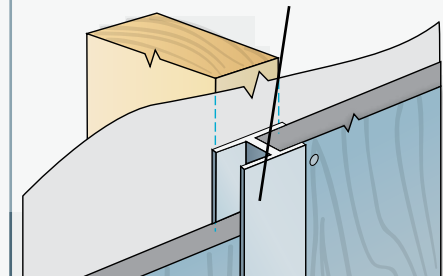
**12.5 3 Battened joint**

HardieTrim® batten board covers the joint between panels.



**12.6 4 H-Channel joint**

A manufactured H-channel captures the vertical edges of the panels.



## HARDIEPANEL SIDING FASTENER SPECIFICATIONS

The Fastener Specifications table shows fastener options for a variety of different nailing substrates. Please refer to the applicable ESR report online (see back page) to determine which fastener meets your wind load

Fastening Substrate	Approved Fastener	Fastening Types
wood studs	16 in o.c.	1 .113 in x .267 in x 1.5 in 4d common
		2 .113 in x .267 in x 2 in 6d common
	24 in o.c.	5 .091 in. x .225 in x 1.5 in ring shank siding nail
steel studs	16 in o.c or 24 in o.c.	9 No. 11ga 1.25 in long roofing nail
		7 Ribbed Bugle-Head No. 8 (.323 in x 1 in) screw
		13 [AKN100-0150NA] .100 in x .25 in x 1.5 in ET&F



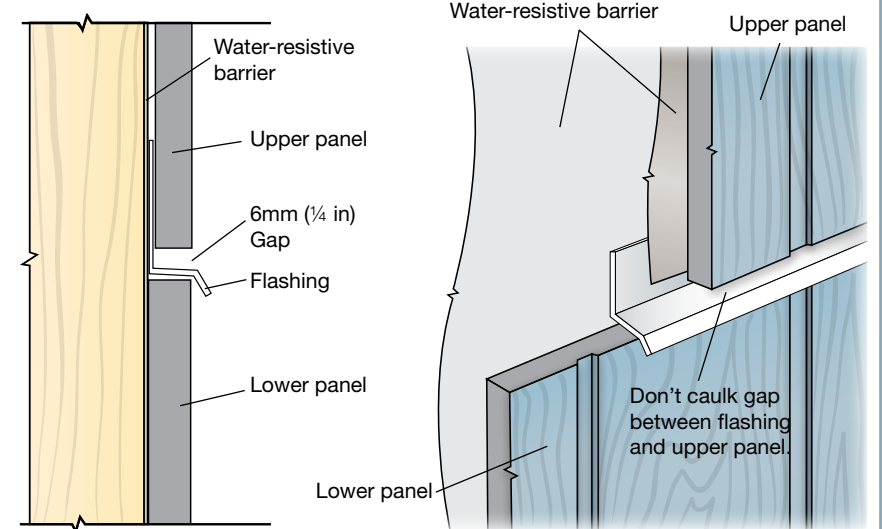
# Installation of HardiePanel® Vertical Siding (cont.)

## HORIZONTAL JOINT TREATMENT

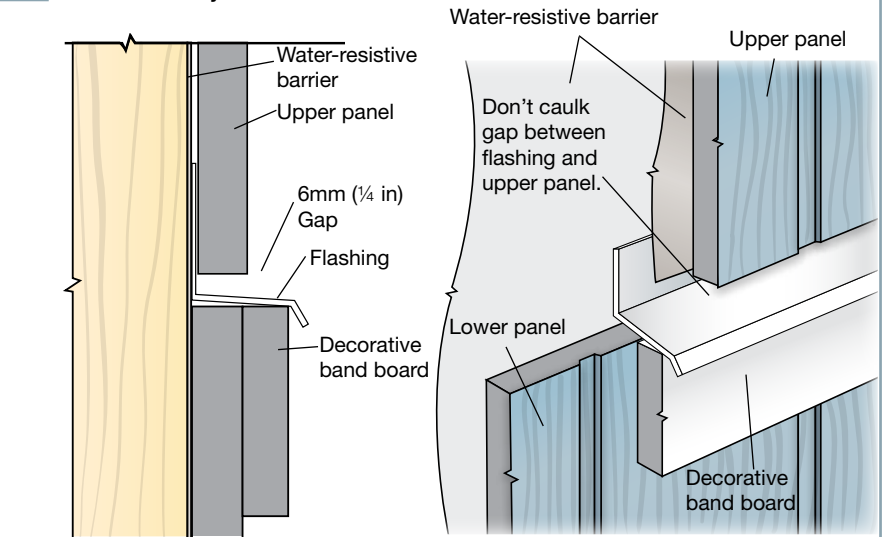
In some applications such as multi-story structures or at gable ends, it may be necessary to stack HardiePanel® siding. The horizontal joints created between panels must be flashed properly to minimize water penetration. Treat horizontal panel joints by using one of the following methods:

1. After installing the lower course of panel siding, install vinyl or coated aluminum “Z” flashing at the top edge of the panel. Make sure that the flashing is sloped away from the wall and does not rest flat on the top edge of the panel. Install the second level or gable panels leaving a ¼ in. minimum gap between the bottom of the panel and the Z flashing. This gap should never be caulked.
2. As an alternative, if a horizontal band board is used at the horizontal joint, flashing must extend over the panel edge and trim attachment. Flashing for both treatments must slip behind the water-resistive barrier.

### 12.7 1 Simple horizontal joint



### 12.8 2 Band-board joint

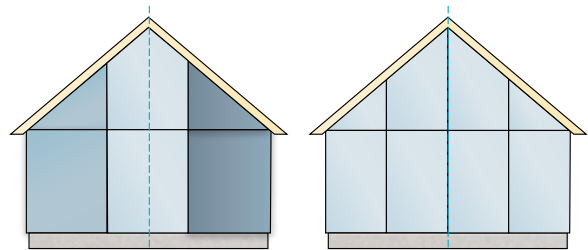


**TIP:** For best looking installation of HardiePanel Select Sierra 8 siding, carefully align vertical panel grooves at 1st to 2nd story or gable junctures.

## WARNING

**Do not bridge floors with panel siding. A horizontal joint shall always be created between floors.**

**TIP:** For the most symmetrical looking wall, plan the installation so that a full panel is centered on the wall or gable with equal-size panels cut for each end. As an alternative, plan the installation so that a full panel is located on either side of the wall center, again leaving equal-size panels on each end. These strategies might entail a centered framing layout. Choose the strategy that looks the best and uses material most efficiently.





## WINDOWS, DOORS, AND OTHER WALL PENETRATIONS

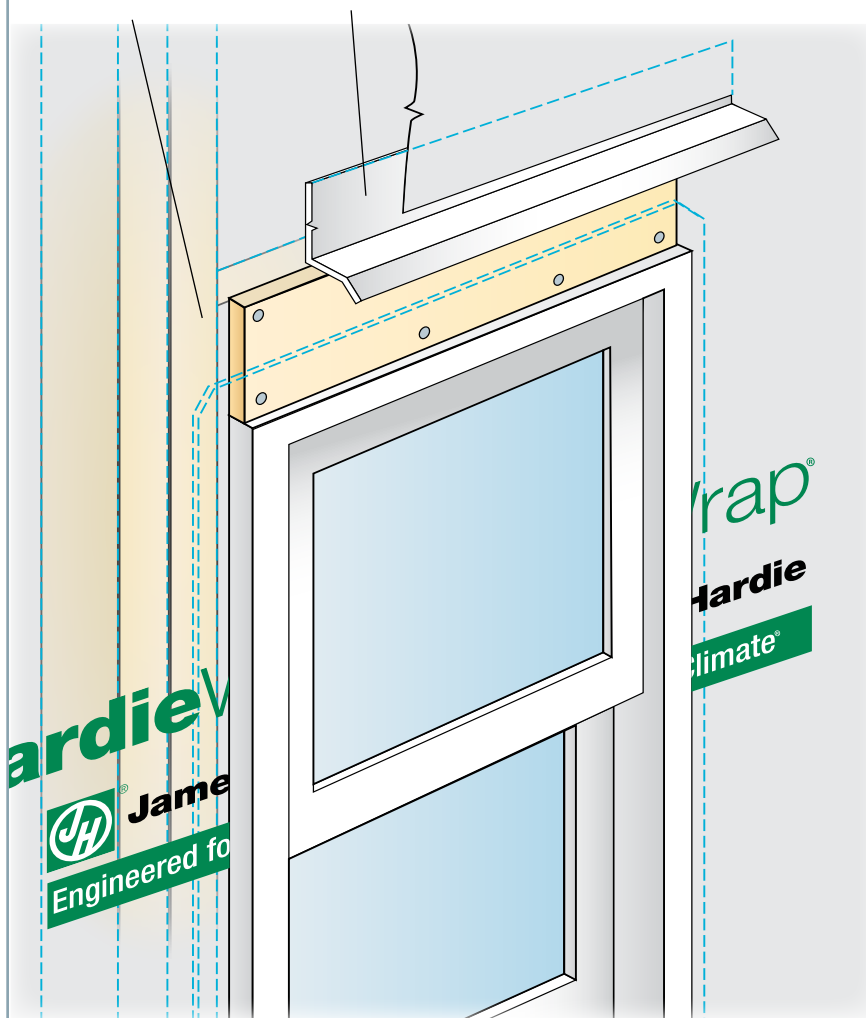
In panel installations, trim is typically overlaid on top of the panel. Special attention needs to be paid to trim flashing at the tops of openings. Below is one method for properly flashing trim in a panel application:

1. After installing the window, cut and install a ¼ in thick shim above the window. The shim should be the same width as the trim, and it should be as long as the width of the window.
2. Over the shim, install flashing wide enough to cover thickness of the trim and long enough to cover the trim head piece.
3. Install the panel to the window and around the shim taking care not to damage the flashing and leaving a ¼ in gap between the panel and the horizontal part of the flashing.
4. Install the trim around the window, slipping the head piece under the installed flashing.

12.9

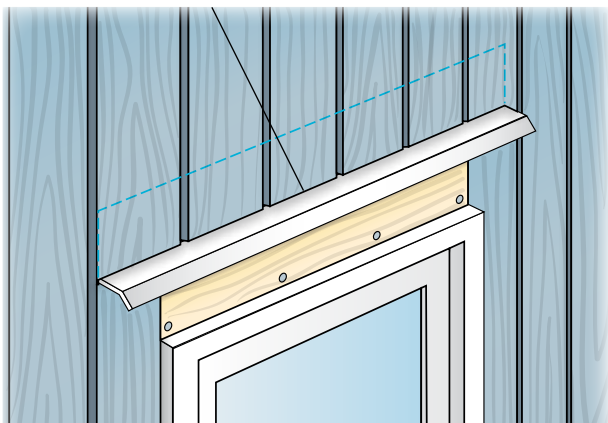
1 Install ¼ in thick shim over the window.

2 Install flashing over the shim and under the water-resistive barrier.



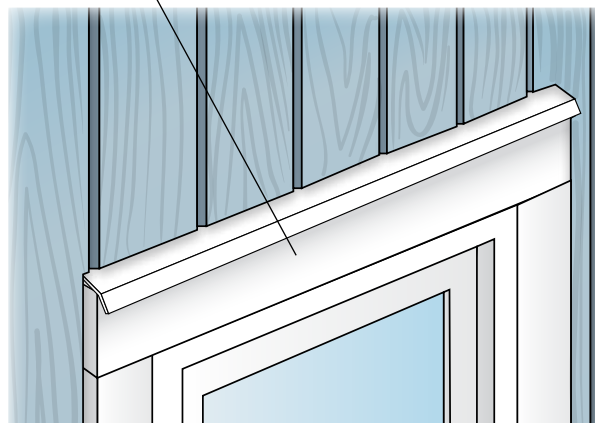
12.10

3 Cut and fit panel around the shim and flashing, Leave ¼ in gap between the flashing and the upper panel.



12.11

4 Install window trim under the flashing.





# HardiePanel® Vertical Siding

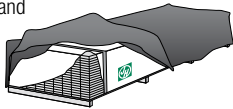
SINGLE FAMILY INSTALLATION REQUIREMENTS

EFFECTIVE SEPTEMBER 2019

**IMPORTANT: FAILURE TO FOLLOW JAMES HARDIE WRITTEN INSTALLATION INSTRUCTIONS AND COMPLY WITH APPLICABLE BUILDING CODES MAY VIOLATE LOCAL LAWS, AFFECT BUILDING ENVELOPE PERFORMANCE AND MAY AFFECT WARRANTY COVERAGE. FAILURE TO COMPLY WITH ALL HEALTH AND SAFETY REGULATIONS WHEN CUTTING AND INSTALLING THIS PRODUCT MAY RESULT IN PERSONAL INJURY. BEFORE INSTALLATION, CONFIRM YOU ARE USING THE CORRECT HARDIEZONE® PRODUCT INSTRUCTIONS BY VISITING HARDIEZONE.COM OR CALL 1-866-942-7343 (866-9-HARDIE)**

## STORAGE & HANDLING:

Store flat and keep dry and covered prior to installation. Installing siding wet or saturated may result in shrinkage at butt joints. Carry planks on edge. Protect edges and corners from breakage. James Hardie is not responsible for damage caused by improper storage and handling of the product.



## CUTTING INSTRUCTIONS

### OUTDOORS

- Position cutting station so that airflow blows dust away from the user and others near the cutting area.
- Cut using one of the following methods:
  - Best:** Circular saw equipped with a HardieBlade® saw blade and attached vacuum dust collection system. Shears (manual, pneumatic or electric) may also be used, not recommended for products thicker than 7/16 in.
  - Better:** Circular saw equipped with a dust collection feature (e.g. Roan® saw) and a HardieBlade saw blade.
  - Good:** Circular saw equipped with a HardieBlade saw blade.

### INDOORS

DO NOT grind or cut with a power saw indoors. Cut using shears (manual, pneumatic or electric) or the score and snap method, not recommended for products thicker than 7/16 in.

- DO NOT dry sweep dust; use wet dust suppression or vacuum to collect dust.
- For maximum dust reduction, James Hardie recommends using the "Best" cutting practices. Always follow the equipment manufacturer's instructions for proper operation.
- For best performance when cutting with a circular saw, James Hardie recommends using HardieBlade® saw blades.
- Go to jameshardiepros.com for additional cutting and dust control recommendations.

**IMPORTANT:** The Occupational Safety and Health Administration (OSHA) regulates workplace exposure to silica dust. For construction sites, OSHA has deemed that cutting fiber cement with a circular saw having a blade diameter less than 8 inches and connected to a commercially available dust collection system per manufacturer's instructions results in exposures below the OSHA Permissible Exposure Limit (PEL) for respirable crystalline silica, without the need for additional respiratory protection.

If you are unsure about how to comply with OSHA silica dust regulations, consult a qualified industrial hygienist or safety professional, or contact your James Hardie technical sales representative for assistance. James Hardie makes no representation or warranty that adopting a particular cutting practice will assure your compliance with OSHA rules or other applicable laws and safety requirements.

## GENERAL REQUIREMENTS:

- These instructions to be used for single family installations only. \*\*For Commercial / Multi-Family installation requirements go to [www.JamesHardieCommercial.com](http://www.JamesHardieCommercial.com)
- HardiePanel® vertical siding can be installed over braced wood or steel studs, 20 gauge (33 mils) minimum to 16 gauge (54 mils) maximum, spaced a maximum of 24 in o.c. or directly to minimum 7/16 in thick OSB sheathing. See General Fastening Requirements. Irregularities in framing and sheathing can mirror through the finished application. Correct irregularities before installing siding.
- Information on installing James Hardie products over non-nailable substrates (ex: gypsum, foam, etc.) can be located in JH Tech Bulletin 19 at [www.jameshardie.com](http://www.jameshardie.com)
- A water-resistive barrier is required in accordance with local building code requirements. The water-resistive barrier must be appropriately installed with penetration and junction flashing in accordance with local building code requirements. James Hardie will assume no responsibility for water infiltration. James Hardie does manufacture HardieWrap® Weather Barrier, a non-woven non-perforated housewrap<sup>1</sup>, which complies with building code requirements.
- Adjacent finished grade must slope away from the building in accordance with local building codes - typically a minimum of 6 in. in the first 10 ft.
- Do not use HardiePanel lap siding in Fascia or Trim applications.
- Do not install James Hardie products, such that they may remain in contact with standing water.
- HardiePanel vertical siding may be installed on flat vertical wall applications only.
- For larger projects, including commercial and multi-family projects, where the span of the wall is significant in length, the designer and/or architect should take into consideration the coefficient of thermal expansion and moisture movement of the product in their design. These values can be found in the Technical Bulletin "Expansion Characteristics of James Hardie® Siding Products" at [www.jameshardie.com](http://www.jameshardie.com).
- James Hardie Building Products provides installation /wind load information for buildings with a maximum mean roof height of 85 feet. For information on installations above 60 feet, please contact JH technical support.
- Minimum standard panel design size is 12" x 16". Note: Panels may be notched and cut to size to fit between windows, doors, corners, etc.

## INSTALLATION:

### Fastener

Position fasteners 3/8 in from panel edges and no closer than 2 in away from corners. Do not nail into corners.

- HardiePanel vertical siding must be joined on stud.
- Double stud may be required to maintain minimum edge nailing distances.
- When screws are used to attach panels to steel studs/furring, the screws shall have wing tips. If screws do not have wing tips, then pre-drilling is required. (Not applicable when using pins) Follow chart below for pre-drilling:

SCREW	PRE-DRILL	HEAD DIAMETER
No. 8	7/32 in	Min 0.323 in
No. 10	1/4 in	Min 0.323 in

### Joint Treatment

- Vertical Joints - Install panels in moderate contact (fig. 1), alternatively joints may also be covered with battens, PVC or metal jointers or caulked (Not applicable to ColorPlus® Finish) (fig. 2).
- Horizontal Joints - Provide Z-flashing at all horizontal joints (fig. 3).

Figure 1

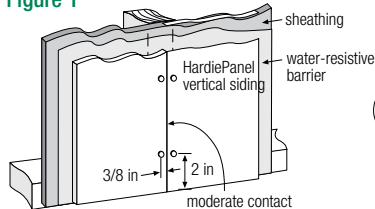


Figure 2

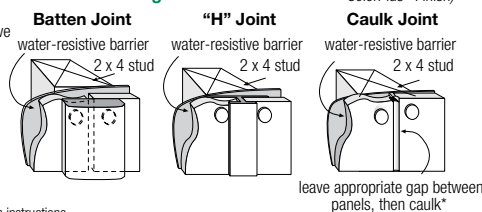


Figure 3

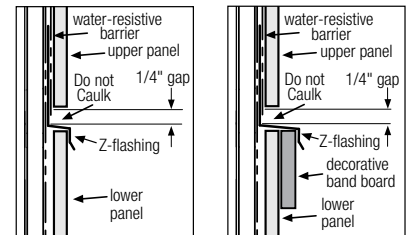
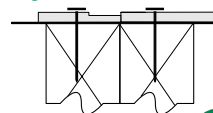


Figure 4



Recommendation: When installing Sierra 8, provide a double stud at panel joints to avoid nailing through grooves.



\*Apply caulk in accordance with caulk manufacturer's written application instructions.  
 \*\*James Hardie recommends installing a rainscreen (an air gap) between the HardiePanel siding and the water-resistive barrier as a best practice.  
 †James Hardie recommends that you consult your design professional if you have questions regarding the use of rainscreen on your single family project.  
 ‡For additional information on HardieWrap™ Weather Barrier, consult James Hardie at 1-866-4Hardie or [www.hardiewrap.com](http://www.hardiewrap.com)

SMOOTH | CEDARMILL® | STUCCO | SIERRA 8

Visit [jameshardiepros.com](http://jameshardiepros.com) for the most recent version.

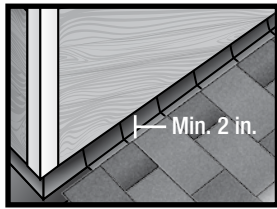


HS1237 P1/3 09/19

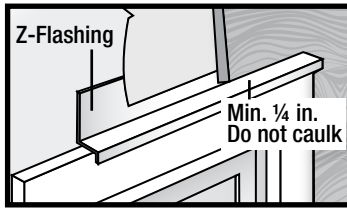


## CLEARANCE AND FLASHING REQUIREMENTS

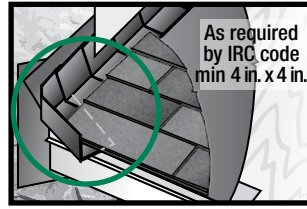
**Figure 3**  
Roof to Wall



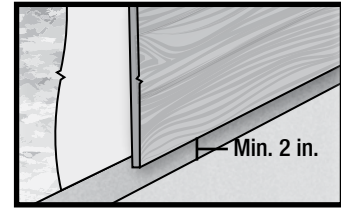
**Figure 4**  
Horizontal Flashing



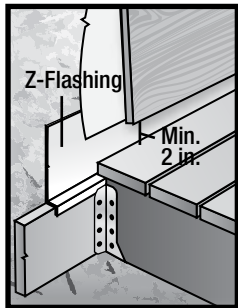
**Figure 5**  
Kickout Flashing



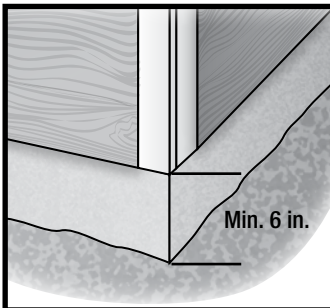
**Figure 6**  
Slabs, Path, Steps to Siding



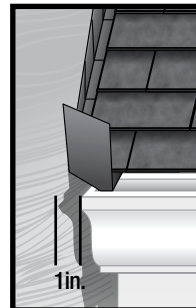
**Figure 7**  
Deck to Wall



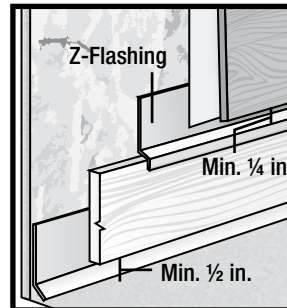
**Figure 8**  
Ground to Siding



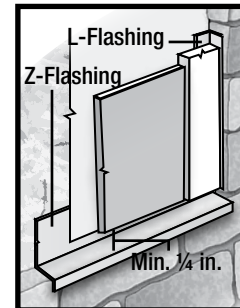
**Figure 9**  
Gutter to Siding



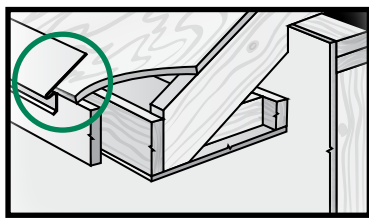
**Figure 10**  
Sheltered Areas



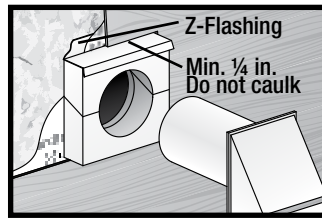
**Figure 11**  
Mortar/Masonry



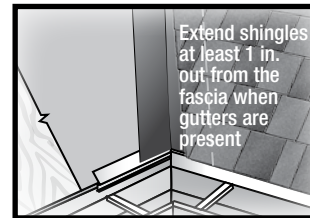
**Figure 12**  
Drip Edge



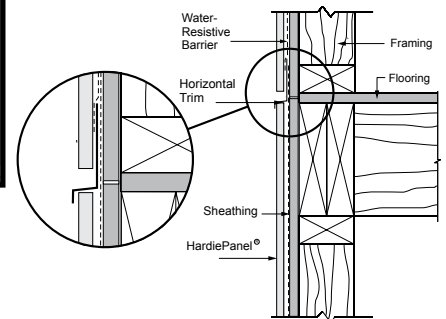
**Figure 13**  
Block Penetration



**Figure 14**  
Valley/Shingle Extension



Do not bridge floors with HardiePanel® siding. Horizontal joints should always be created between floors, see below).



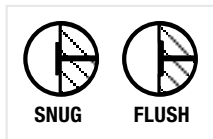
## GENERAL FASTENING REQUIREMENTS

Refer to the applicable ESR report online to determine which fastener meets your wind load design criteria.

Fasteners must be corrosion resistant, galvanized, or stainless steel. Electro-galvanized are acceptable but may exhibit premature corrosion. James Hardie recommends the use of quality, hot-dipped galvanized nails. James Hardie is not responsible for the corrosion resistance of fasteners. Stainless steel fasteners are recommended when installing James Hardie® products near the ocean, large bodies of water, or in very humid climates.

Manufacturers of ACQ and CA preservative-treated wood recommend spacer materials or other physical barriers to prevent direct contact of ACQ or CA preservative-treated wood and aluminum products. Fasteners used to attach HardieTrim Tabs to preservative-treated wood shall be of hot dipped zinc-coated galvanized steel or stainless steel and in accordance to 2009 IRC R317.3 or 2009 IBC 2304.9.5

- Consult applicable product evaluation or listing for correct fasteners type and placement to achieve specified design wind loads.
- NOTE: Published wind loads may not be applicable to all areas where Local Building Codes have specific jurisdiction. Consult James Hardie Technical Services if you are unsure of applicable compliance documentation.
- Drive fasteners perpendicular to siding and framing.
- Fastener heads should fit snug against siding (no air space).
- NOTE: Whenever a structural member is present, HardiePanel® should be fastened with even spacing to the structural member. The tables allowing direct to OSB or plywood should only be used when traditional framing is not available.



<b>DO NOT</b>	
<b>UNDER DRIVE</b>	
<b>IF, THEN</b>	
<b>WOOD FRAME</b>	<b>STEEL FRAME</b>
HAMMER FLUSH	REMOVE & REPLACE

<b>DO NOT</b>	
<b>OVER DRIVE</b>	<b>SLANT</b>
<b>IF, THEN ADDITIONAL NAIL</b>	
<b>FACE NAIL</b>	
COUNTERSINK & FILL	

<b>DO NOT USE</b>
<b>ALUMINUM FASTENERS</b>
<b>CLIPPED HEAD NAILS</b>
<b>STAPLES</b>



## PNEUMATIC FASTENING

James Hardie products can be hand nailed or fastened with a pneumatic tool. Pneumatic fastening is highly recommended. Set air pressure so that the fastener is driven snug with the surface of the siding. A flush mount attachment on the pneumatic tool is recommended. This will help control the depth the nail is driven. If setting the nail depth proves difficult, choose a setting that under drives the nail. (Drive under driven nails snug with a smooth faced hammer - Does not apply for installation to steel framing).

## CUT EDGE TREATMENT

Caulk, paint or prime all field cut edges. James Hardie touch-up kits are required to touch-up ColorPlus products.

## CAULKING

For best results use an Elastomeric Joint Sealant complying with ASTM C920 Grade NS, Class 25 or higher or a Latex Joint Sealant complying with ASTM C834. Caulking/Sealant must be applied in accordance with the caulking/sealant manufacturer's written instructions. **Note: some caulking manufacturers do not allow "tooling".**

## PAINTING

DO NOT use stain, oil/alkyd base paint, or powder coating on James Hardie® products. James Hardie products must be painted within 180 days for primed product and 90 days for unprimed. 100% acrylic topcoats are recommended. Do not paint when wet. For application rates refer to paint manufacturers specifications. Back-rolling is recommended if the siding is sprayed.

## PAINTING JAMES HARDIE® SIDING AND TRIM PRODUCTS WITH COLORPLUS® TECHNOLOGY

When repainting ColorPlus products, James Hardie recommends the following regarding surface preparation and topcoat application:

- Ensure the surface is clean, dry, and free of any dust, dirt, or mildew
- Repriming is normally not necessary
- 100% acrylic topcoats are recommended
- DO NOT use stain, oil/alkyd base paint, or powder coating on James Hardie® Products.
- Apply finish coat in accordance with paint manufacturers written instructions regarding coverage, application methods, and application temperature
- DO NOT caulk nail heads when using ColorPlus products, refer to the ColorPlus touch-up section

## COLORPLUS® TECHNOLOGY CAULKING, TOUCH-UP & LAMINATE

- Care should be taken when handling and cutting James Hardie ColorPlus® products. During installation use a wet soft cloth or soft brush to gently wipe off any residue or construction dust left on the product, then rinse with a garden hose.
- Touch up nicks, scrapes and nail heads using the ColorPlus® Technology touch-up applicator. Touch-up should be used sparingly. If large areas require touch-up, replace the damaged area with a new piece of siding with ColorPlus® Technology.
- Laminate sheet must be removed immediately after installation of each course.
- Terminate non-factory cut edges into trim where possible, and caulk. Color matched caulks are available from your ColorPlus® product dealer.
- Treat all other non-factory cut edges using the ColorPlus Technology edge coat, available from your ColorPlus product dealer.

Note: James Hardie does not warrant the usage of third party touch-up or paints used as touch-up on James Hardie ColorPlus products.

Problems with appearance or performance arising from use of third party touch-up paints or paints used as touch-up that are not James Hardie touch-up will not be covered under the James Hardie ColorPlus Limited Finish Warranty.

HS1237 P3/3 09/19

### SILICA WARNING

**DANGER:** May cause cancer if dust from product is inhaled. Causes damage to lungs and respiratory system through prolonged or repeated inhalation of dust from product. Refer to the current product Safety Data Sheet before use. The hazard associated with fiber cement arises from crystalline silica present in the dust generated by activities such as cutting, machining, drilling, routing, sawing, crushing, or otherwise abrading fiber cement, and when cleaning up, disposing of or moving the dust. When doing any of these activities in a manner that generates dust you must (1) comply with the OSHA standard for silica dust and/or other applicable law, (2) follow James Hardie cutting instructions to reduce or limit the release of dust; (3) warn others in the area to avoid breathing the dust; (4) when using mechanical saw or high speed cutting tools, work outdoors and use dust collection equipment; and (5) if no other dust controls are available, wear a dust mask or respirator that meets NIOSH requirements (e.g. N-95 dust mask). During clean-up, use a well maintained vacuum and filter appropriate for capturing fine (respirable) dust or use wet clean-up methods - never dry sweep.

**WARNING:** This product can expose you to chemicals including respirable crystalline silica, which is known to the State of California to cause cancer. For more information go to [P65Warnings.ca.gov](http://P65Warnings.ca.gov).

**RECOGNITION:** In accordance with ICC-ES Evaluation Report ESR-1844, HardiePanel® vertical siding is recognized as a suitable alternate to that specified in the 2006, 2009, 2012 & 2015 International Residential Code for One- and Two-Family Dwellings and the 2006, 2009, 2012 & 2015 International Building Code. HardiePanel vertical siding is also recognized for application in the following: City of Los Angeles Research Report No. 24862, State of Florida Product Approval FL#13223, Miami-Dade County Florida NOA No. 17-0406.06, U.S. Dept. of HUD Materials Release 1263f, Texas Department of Insurance Product Evaluation EC-23, City of New York MEA 223-93-M, and California DSA PA-019. These documents should also be consulted for additional information concerning the suitability of this product for specific applications.



## Additional Information

### RAINSCREENS

**Note: James Hardie has a capillary break requirement when installing HardiePanel on a Multi-Family/Commercial project. Please visit [jameshardiepros.com](http://jameshardiepros.com) for further information.**

#### The Optional Use of Rain Screen Systems:

James Hardie will support the use of its exterior siding products with rainscreen systems, but does not take responsibility for the entire wall assembly or system. James Hardie expects the designer or builder using our components as part of the rainscreen system to:

- Adhere to all the installation requirements listed in the relevant product installation instructions.
- Provide adequate details for water management.
- Make the decision about the use of rainscreen.
- James Hardie products does not recommend “drainage mats” or “drainage boards” to provide the necessary capillary break behind our siding. These products can compress during the installation process, impairing the drainage channels and further causing a “wavy” appearance in the plank or panel products.
- Understand the interaction between system components and how each of the components in the system interacts.
- Design of the building envelope accounting for both interior and exterior moisture control.

#### Installation Over Furring:

When installing James Hardie Siding products over furring the question arises what thickness of furring can be used as an alternate to normal metal or wood studs specified in the ESR 1844 & 2290 Report. General rule of thumb is, the specific ESR 1844 & 2290 fastener must be installed into a material that has the same or better holding power than that specified in the ESR 1844 & 2290 and with the same penetration as the ESR 1844 & 2290 fastener.

Note: The ESR 1844 & 2290 is the primary code compliance document James Hardie utilizes, but for other common applications and/or products, additional code compliance documentation and/or fastener specifications may exist. For special circumstances out side the scope of the ESR 1844 & 2290, please contact James Hardie’s Technical Services.

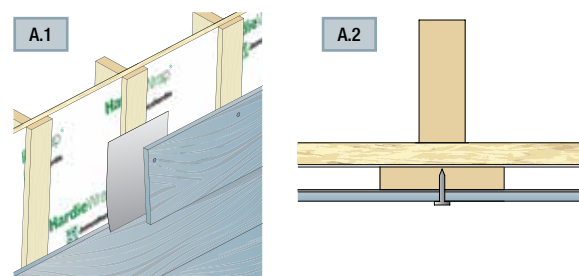
When reviewing the following details for attaching to wood furring or framing, an important consideration is that the fastener chosen must be fully encompassed by a wood substrate - the furring may count as all or part of the necessary penetration if it has been proven that the furring and/or wood substrate has the same or better holding power as a timber stud.

#### Design responsibility

In all cases it is the sole responsibility of the architect, envelope engineer or specifier to identify moisture related risks associated with any particular building design and to make any appropriate adjustments or modifications to the installation guidelines given by manufacturers. Wall construction and design must effectively manage moisture, considering both the interior and exterior environment of the building.

#### Attaching lap siding to wood furring:

When attaching lap siding products over wood furring, the typical fastener used is the 1¼ in. long No. 11 ga. roofing nail, blind nailed. This fastener is going to be the shortest fastener approved for fastening lap siding products, therefore the furring must be a minimum of 0.75 in thick to achieve the same values as ESR 2290 Table 4 states for the 11 ga. 1¼ in. roofing nail given plank reveal, stud spacing, building height and exposure category.



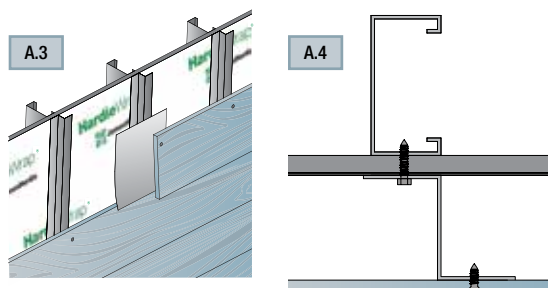


# Appendix A (cont.)

## RAIN SCREENS

### Attaching lap siding to steel furring:

When attaching lap siding products to metal furring, the steel furring must be 20 gauge (33 mils) minimum to 16 gauge (54 mils) maximum. A fastener should be chosen out of the ESR 2290, Table 4, which is approved for attaching to steel framing. Two general rules that should be considered when choosing a fastener is that a nail (pin) must penetrate steel furring  $\frac{1}{4}$  in, and screws must penetrate steel furring 3 full threads. Therefore, if the rules for steel fastening are followed – given plank reveal, stud spacing, building height, and exposure category – the values are the same as ESR 2290, Table 4 states for the chosen fastener.



### Attaching panel siding to wood furring:

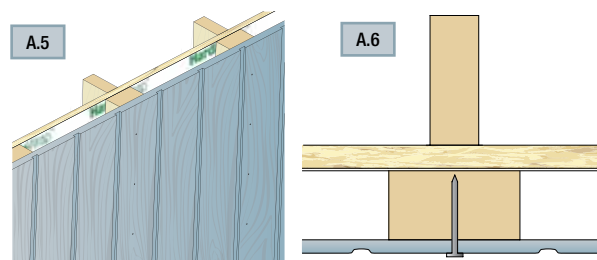
When attaching panel siding products over wood furring, the typical fastener used is the 6d common 2 in. long nail. This fastener is going to be the shortest fastener approved for fastening panel siding products into wood, therefore the furring must be a minimum of 1-11/16 in thick to achieve the same values as ESR 1844, Table 4, given stud spacing, building height, and exposure category.

It is deemed an acceptable practice to not fasten along the top and bottom plates for the 5/16 in HardiePanel configurations listed in the ESR 1844, Table 4 using the following fastener type:

- 0.091 in. shank X 0.225 in HD X 1.5 in long ring shank nail
- Min No. 8 X 0.311 HD X 1 in. ribbed bugle head screw
- 0.10 X 0.25 in HD X 1.5 in long ET&F pin or equivalent
- 6d common 2 in. long nail

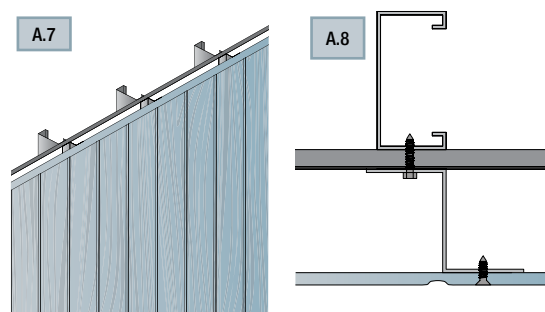
### Conditions of use:

- This practice is acceptable for transverse load only.
- This practice is not acceptable for racking shear values or in-plane forces other than perpendicular/normal wind forces.
- All vertical joints shall occur over framing.
- All other James Hardie Installation Requirements shall be followed.



### Attaching panel siding to steel furring:

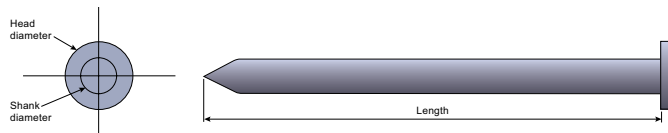
When attaching panel siding products to metal furring, the steel furring must be 20 gauge (33 mils) minimum to 16 gauge (54 mils) maximum. A fastener should be chosen out of the ESR 1844, Table 4, which is approved for attaching to steel framing. Two general rules that should be considered when choosing a fastener is that a nail (pin) must penetrate steel furring  $\frac{1}{4}$  in, and screws must penetrate steel furring 3 full threads. Therefore, if the rules for steel fastening are followed – given stud spacing, building height, and exposure category – the values are the same as ESR 1844, Table 4 states for the chosen fastener.



## ATTACHING JAMES HARDIE PRODUCTS TO INSULATED CONCRETE FORMS (ICF)

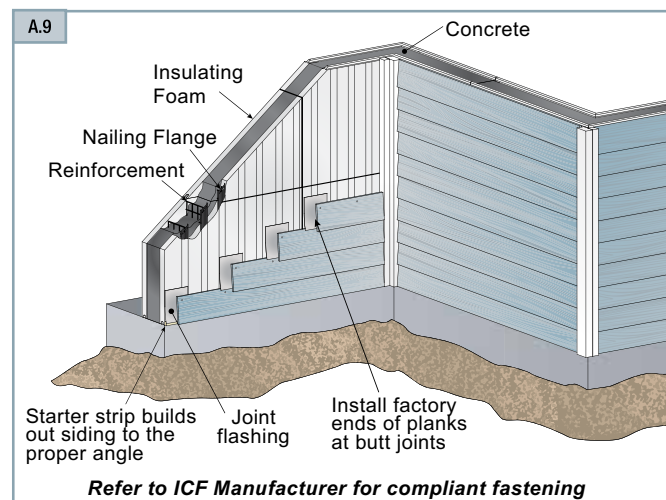
Considering the proprietary nature of Insulated Concrete Forms (ICF) and the number of ICF manufacturers currently selling product in the US and Canada, James Hardie Building Products cannot calculate or determine the proper fastener for each type of plastic or metal cross-tie flange being used in the field. James Hardie offers the following as a guide to determine the correct siding fastening to be used with the respective ICF system chosen for the project in question.

1. Determine the projects basic wind design, including basic wind speed, wind exposure category, and mean roof height. Find the fastener and frame type within James Hardie's ICC-ES Product Evaluation Report (e.g. ESR 1844 & 2290) that will meet the project's basic wind design.
  - a. Take note of the head diameter, shank diameter, and fastener length for the fastener.
  - b. Take note of the frame type and frame spacing.



Note: Fastener bearing area is equal to the head area less the shank area.

3. Go to the ICF system manufacturer and find a fastener that is similar in dimension to the fastener from step 2.1 above.
  - a. Basically, the bearing area under the ICF fastener head shall be the same as or greater than the bearing area under the James Hardie fastener head from step 2.
4. Since the James Hardie siding product has to be attached to a structural member, in this case the ICF cross-tie flange, the steps below shall be followed.
  - a. The onus is on the ICF system manufacturer to demonstrate that their ICF cross-tie flange holds fasteners, screws or nails, the same as wood or steel framing hold screws or nails.
  - b. ICF fastener allowable withdrawal load capacity (applicable factor of safety applied) may be found in an ICC-ES Product Evaluation for the given ICF manufacturer's products, OR
  - c. The ICF manufacturer may have testing that shows their fastener's allowable withdrawal load capacity (applicable factor of safety applied) from their cross-tie flange.
5. For the fastener from step 2, a registered design professional shall calculate the allowable withdrawal load (factor of safety applied) from the frame type noted in step 2.2.
6. A registered design professional shall then make an equivalency statement comparing the ICF fastener withdrawal (step 4.1.1 or step 4.1.2) versus the fastener withdrawal from step 5.
7. When the ICF cross-tie flange spacing differs from the James Hardie frame spacing in step 2.2, a registered design professional shall calculate the maximum siding fastener spacing into the cross-tie flange needed to resist the applicable basic wind speeds published in James Hardie's ESR 1844 & 2290 for the fastener and design from step 2.
8. When required by the code official and once in possession of the information gathered in the steps above it is the responsibility of the property owner, design professional, contractor, or installer to make his or her case to the Building Official<sup>1</sup>.



<sup>1</sup>The Building Official reserves the right to approve alternate materials, design and methods of construction, 2006 International Building Code® Section 104.11, 2006 International Residential Code® Section R104.11, and 1997 Uniform Building Code™ Section 104.2.8.

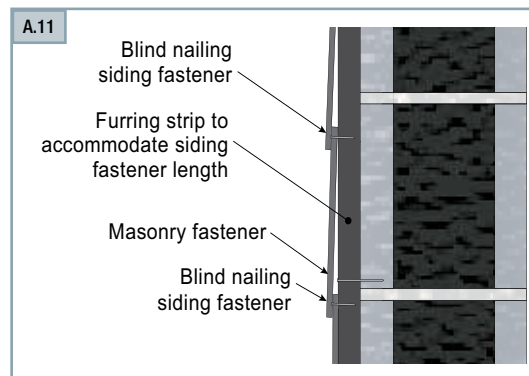
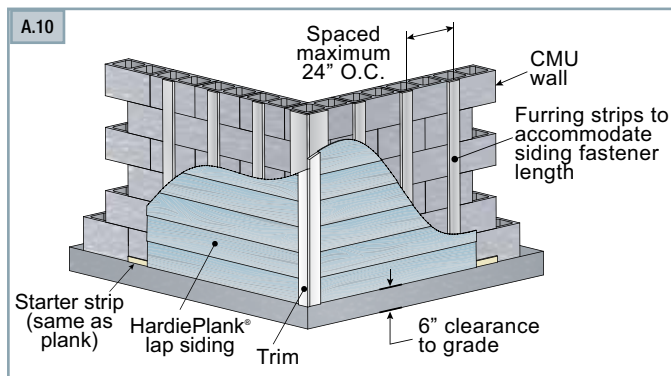
# Appendix A (cont.)

## ATTACHING HARDIEPLANK® LAP SIDING AND HARDIETRIM® PRODUCTS TO CONCRETE MASONRY UNITS (CMU)

The application of HardiePlank® Lap Siding and HardieTrim® boards to masonry construction complying with local building codes using Concrete Masonry Units (CMU) complying to ASTM C 90 can be achieved by using one of the following two methods of attachment. All other product specific installation requirements which are not outlined below must be followed.

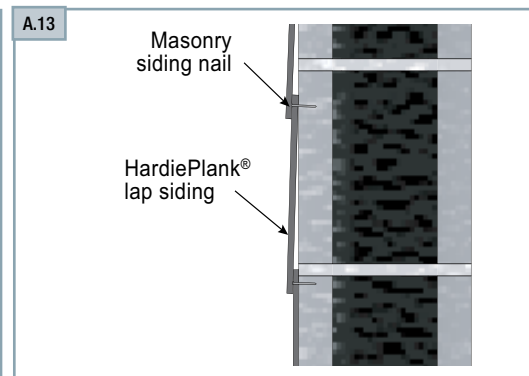
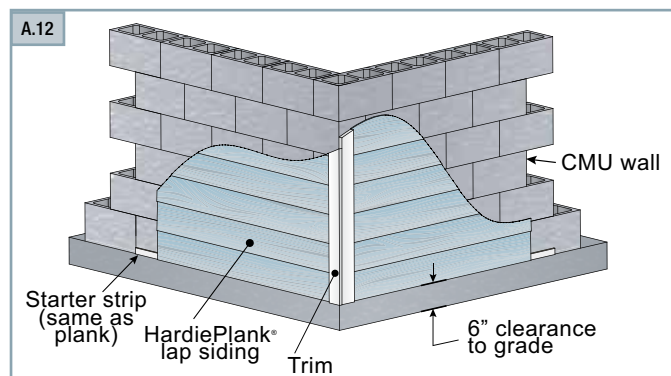
### Method 1: Attachment Over Furring

Attach over furring with adequate thickness to allow attachment with approved fastening methods according to local building codes and code compliance documentation. Furring must be attached to ensure it can transfer the wind loads and other necessary forces back to the structure. The mechanical connection of the furring to the structure is the responsibility of the Licensed Design Professional. James Hardie Building Products has no comment on the load carrying capacity of the furring to framing connections.



### Method 2: Attachment Directly to CMU

Attach directly to masonry with approved fastening method according to local building codes and code compliance documentation. Refer to and follow local building codes for water resistive barrier requirements.



### Fastening to CMU

For information on fastening James Hardie products to CMU refer to ESR 1844 & 2290.

### Attachment of HardieTrim® boards

HardieTrim boards can be fastened using hardened finish nails designed for masonry construction. For more information refer to the HardieTrim section of this guide.

## WEATHER BARRIER & RIGID FOAM

- When using a weather resistive barrier (WRB) in conjunction with rigid foam insulation, the WRB can be installed underneath the foam as shown, or over the top if more convenient
- Regardless of where the WRB is placed all flashings must be incorporated into the WRB and drainage plane.
- Some rigid foam insulation products are manufactured with tongue & groove or shiplap joints and can be used as the WRB when properly installed and sealed. When using rigid foam insulation as the WRB refer to manufacturers installation instructions.

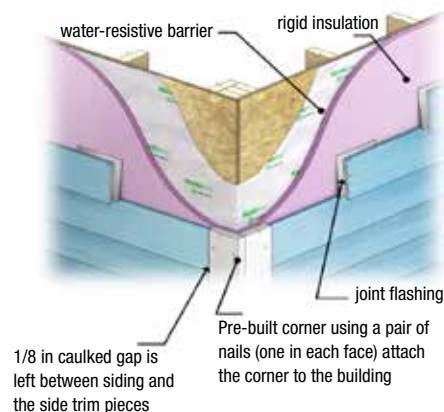
### Trim

Depending upon the reveal around windows, doors, & penetrations, thickness of foam and the type and thickness of trim used there will be different techniques to install the siding and trim to ensure the foam is completely concealed.

### Flashings

The Z flashing above all horizontal trim must be incorporated into the WRB regardless of WRB position. If the foam is being used per manufacturers instructions as the WRB, all flashings must be incorporated into the drainage plane such that it allows moisture to drain down and out.

A.17



**Note:** It is recommended to layout the rigid foam insulation such that vertical joints do not occur at the corners of window and door openings or overs if possible.

A.18



# Appendix A (cont.)

## JOINT FLASHING WITH HARDIEPLANK® LAP SIDING

One or more of the following joint treatment options are required by code (as referenced 2009 IRC R703.10.2)

- A. Joint Flashing (James Hardie recommended)
- B. Caulking\* (Caulking is not recommended for ColorPlus for aesthetic reasons as the Caulking and ColorPlus will weather differently. For the same reason, do not caulk nail heads on ColorPlus products.)
- C. "H" jointer cover Flashing behind butt joints provides an extra level of protection against the entry of water at the joint.

James Hardie recommends 6 in. wide flashing that overlaps the course below by 1 in. Some local building codes may require different size flashing. Joint-flashing material must be durable, waterproof materials that do not react with cement products. Examples of suitable material include finished coil stock and code compliant water-resistive barriers. Other products may also be suitable.

### The reasons for this are:

1. The use of joint flashing behind field butt joints is an approved joint treatment method as described in the 2006 International Building Code and is recognized by James Hardie and experts across the building industry to be a superior method.

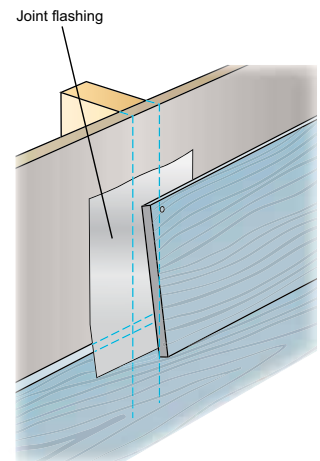
*"1405.17.2 Horizontal lap siding. Lap siding shall be lapped a minimum of 1 1/4 inches (32 mm) and shall have the ends sealed with caulking, covered with an H section joint cover or located over a strip of flashing."*

Experts across the industry recognize flashings as an effective and responsible method for draining a wall system:

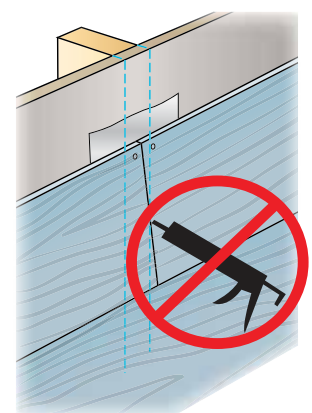
*"The fundamental principle of water management is to shed water by layering materials in such a way that water is directed downwards and outwards out of the building or away from the building. The key to this fundamental principle is drainage. The most elegant expression of this concept is a flashing. Flashings are the most under-rated building enclosure component and arguably the most important."*

EEBA (Energy & Environmental Building Association™) Water Management Guide By Joseph W. Lstriburek, Ph.D., P.eng. June 2004.

2. Reduced maintenance required by the home owner – It is recognized by James Hardie, several caulking manufacturers, experts across the industry, and experienced home owners that when caulking is used at field butt joints, maintenance will be required. Depending on the specific product and the application, caulked field butt joints will need to be maintained to guarantee continued performance over the life of the building. In addition, several sealant/caulking manufacturers recommend against using their products at butt joints in fiber cement siding for many of the reasons discussed here.
3. Improved appearance – When installed properly, flashing at a field butt joint can create a better looking joint. James Hardie recommends butting field joints together in moderate contact which achieves a more continuous looking joint. When utilizing a caulked butt joint, a gap specified by the caulk manufacturer must be left at the joint. Over time as the caulk ages, this joint can become pronounced on the wall and stand out.



A.21



A.22

Do not use caulk on HardiePlank® lap siding with ColorPlus® technology



## JAMES HARDIE REQUIREMENTS FOR ALTERNATE FASTENERS AND METHODS OF FASTENING

The fastening requirements for each product are stated in one or more of the following technical documents and in some cases fastener products may be referenced. Below are the steps that can be used to demonstrate an alternate fastener's equivalency to the James Hardie published fastening requirements.

1. It is the responsibility of either the property owner, design professional, contractor, or installer to consult:
  - a. The fastener Manufacturer for a Product Listing Specification or Code Compliance report that covers the installation method in question, or;
  - b. A licensed Architect or Professional Engineer to make an equivalency statement linking the alternate fastener (or fastening method) to the fastening requirements published within the relevant James Hardie technical document;
2. Once in possession of the information gathered in step one it is the responsibility of the property owner, design professional, contractor, or installer to make his or her case to the Building Official<sup>1</sup>

<sup>1</sup>The Building Official reserves the right to approve alternate materials, design and methods of construction, 2006 International Building Code® Section 104.11, 2006 International Residential Code Section R104.11, and 1997 Uniform Building Code Section 104.2.8. All national, state, and local building code requirements must be followed and where they are more stringent than the James Hardie installation requirements, state and local requirements will take precedence.

# Appendix B

## Estimating

### Siding

All houses can be broken down to triangles, rectangles, and squares. Using these simple shapes it is very easy to estimate the amount of siding required.

1. Break down the portions of the house to be sided into the simple shapes (squares, rectangles, triangles) Figures 12.1 - 12.4.
2. Determine the height and width of each shape.
3. Multiply height x width to determine square footage. For triangles divide the total by 2.
4. Add all of the square footage numbers together.
5. Subtract large items such as garage doors, large doors, large windows, and banks of windows from total.  
Do not remove small windows, doors, vents, or other small areas not being sided.
6. Total all numbers. This gives you the total covered area.
7. Use the coverage charts located in this section to determine the number needed.
8. Add a minimum of 5% for waste. If there are multiple (3 or more) gables, chases, bump outs, or dormers add 10%.\*

\* Material for starter strip is included in the calculation for waste.

### Trim

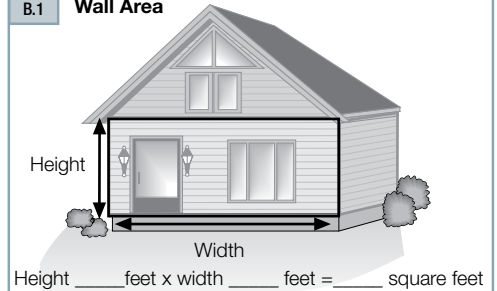
Number of HardieTrim® Boards:

Trim is applied to corners and around doors and windows. Trim is also used for fascia board, rake board, band board, frieze board and other details.

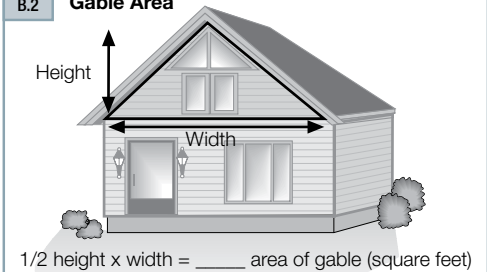
1. Determine which areas are to be trimmed.
2. Measure all openings to be trimmed including doors, windows, vent openings, corners (inside and outside), and other areas.
3. Measure for fascia, rakes, and frieze boards.
4. Add the lengths for corners, fascia, rakes, and frieze and add 5% for waste.
5. Add the lengths for window and door trim and add 10% for waste.
6. Add the total from lines 4 and 5 to determine the amount of trim needed.

The estimation methods in this section are meant as a guide. James Hardie does not assume responsibility for over or under ordering of product.

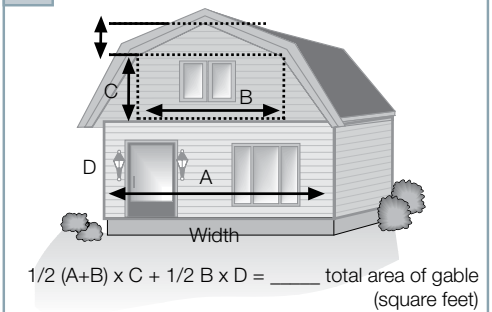
B.1 Wall Area



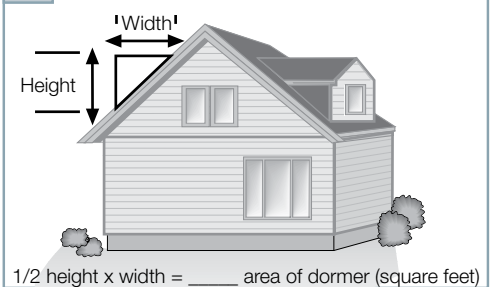
B.2 Gable Area



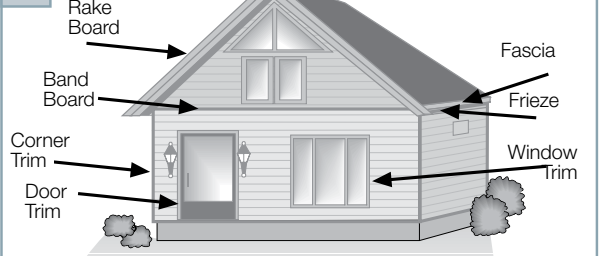
B.3 Gambrel Roof House



B.4 Dormer Area



B.5



**HardiePlank® Lap Siding**  
Coverage Chart\* (number of planks)

Coverage Area (square feet)	Plank Width (in)					
	W. (in) 5.25 Exp. (in) 4	6.25 5	7.25 6	8.25 7	9.25 8	12 10.75
100	25	20	17	14	13	9
200	50	40	33	29	25	19
300	75	60	50	43	38	28
400	100	80	67	57	50	37
500	125	100	83	71	63	47
600	150	120	100	86	75	56
700	175	140	117	100	88	65
800	200	160	133	114	100	74
900	225	180	150	129	113	84
1000	250	200	167	143	125	93
1100	275	220	183	157	138	102
1200	300	240	200	171	150	112
1300	325	260	217	186	163	121
1400	350	280	233	200	175	130
1500	375	300	250	214	188	140
1600	400	320	267	229	200	149
1700	425	340	283	243	213	158
1800	450	360	300	257	225	167
1900	475	380	317	271	238	177
2000	500	400	333	286	250	186
2100	525	420	350	300	263	195
2200	550	440	367	314	275	205
2300	575	460	383	329	288	214
2400	600	480	400	343	300	223
2500	625	500	417	357	313	233
2600	650	520	433	371	325	242
2700	675	540	450	386	338	251
2800	700	560	467	400	350	260
2900	725	580	483	414	363	270
3000	750	600	500	429	375	279

**HardiePanel® Vertical Siding**  
Coverage Chart\* (number of panels)

Coverage Area (square feet)	Panel Size (ft)		
	4x8 (32SF)	4x9 (36SF)	4x10 (40SF)
100	4	3	3
200	7	6	5
300	10	9	8
400	13	12	10
500	16	14	13
600	19	15	15
700	22	20	18
800	25	23	20
900	29	25	23
1000	32	28	25
1100	35	31	28
1200	38	34	30
1300	41	37	33
1400	44	39	35
1500	47	42	38
1600	50	45	40
1700	54	48	43
1800	57	50	45
1900	60	53	48
2000	63	56	50
2100	66	59	53
2200	69	62	55
2300	72	64	58
2400	75	67	60
2500	79	70	63
2600	82	73	65
2700	85	75	68
2800	88	78	70
2900	91	81	73
3000	94	84	75

**Nail Coverage Chart\*\* (number of nails)**

Coverage Area (square feet)	Plank Width (in)					
	Width (in) 5.25 Exposure (in) 4	6.25 5	7.25 6	8.25 7	9.25 8	12 10.75
100	250	200	166	143	125	93
500	1250	1000	830	715	625	465
1000	2500	2000	1660	1430	1250	930

The estimation methods in this section are meant as a guide. James Hardie does not assume responsibility for over or under ordering of product.  
\*Coverage chart does not include waste. \*\* Number of nails given are for building framed 16 in o.c.

# Appendix B (cont.)

## HardieShingle® Siding

### HardieShingle Staggered Edge Notched Panel Coverage

Panels are available in 48 in lengths. Pieces needed for one square (100 sq. ft) of product coverage = approximately 50, (depending on ratio of length to height of wall) based on maximum exposure of 6 in

### HardieShingle Straight Edge Notched Panels Coverage

Panels are available in 48 in lengths. Pieces needed for one square (100 sq. ft) of product coverage = approximately 43, (depending on ratio of length to height of wall) based on maximum exposure of 7 in.

### HardieShingle Half-round Notched Panel Coverage

Panels are available in 48 in lengths. Pieces needed for one square (100 sq. ft) of product coverage = approximately 43, based on a maximum exposure of 7 in.

### HardieShingle Individual Shingle Coverage\*

Shingles are available in 4.2 in, 5.5 in, 6.75 in, 7.25 in and 10 in widths, Bundles needed for one square (100 sq. ft) of product coverage:

Shingle Width # of Bundles (5 in Exp.)# of Bundles (7 in Exp.) Pieces per Bundle (5 in Exp.)Pieces per Bundle (7 in Exp.)

4.2 in.	3	3	20	15
5.5 in	6	6	20	15
6.75 in	6	3	20	15
7.25 in	6	6	20	15
10 in	3	3	20	15

\* Individual shingles are not available in all areas. Check you local dealer for availability.

### HardieSoffit® Panels

- For 12 in. and 16 in width soffits: Divide total lineal footage of soffit and/or eaves by 12.
- For 24 in width soffits: Divide total lineal footage of soffit and/or eaves by 8.

## Glossary of Building Terms

**Back Roll** - To roll over a freshly spray painted surface with a roller.

**Back Sealing/Priming** - Back sealing and back priming are used interchangeably in the field and refer to the act of applying a sealer or primer to the back of a cladding material to minimize the potential for water absorption through the backside of the product.

**Band Board** - A decorative piece of trim placed between two floors along the rim joist.

**Bevel Cut** - See weather cut

**Blind Nailing** - The action of placing a fastener through the top edge of lap siding that will be covered by the next course of siding.

**Bump Out** - A built out protrusion from a building.

**Butt Joint** - To place materials end-to-end or end-to-edge without overlapping. Also known as a field joint.

**Caulk** - A compound used to fill cracks, gaps, seams and joints.

**Chase** - A framed enclosed space around a flue pipe or a channel in a wall, or through a ceiling for something to lie in or pass through.

**Course** - A row of planks, one plank wide running the length of the house.

**Dormer** - A gabled extension built out from a sloping roof to accommodate a vertical window.

**Drip Cap** - A molding or metal flashing placed on the exterior topside of a door or window frame to cause water to drip beyond the outside of the frame.

**Drip Edge** - A metal or vinyl flashing placed on the top edge of the roof sheathing which directs water away from the structure to prevent seepage under or behind the exterior trim or fascia.

**Eave** - The lower part of the roof that projects over the exterior wall assembly.

**Electro-Galvanized** - Covered with zinc using a plating process.

**Face** - The side of the siding, trim, or soffit showing once the product has been installed.

**Face Nailing** - The action of placing a fastener through the overlap of a plank. The fastener will be visible.

**Fascia Board** - A trim board attached to the ends of the rafters.

**Finished Grade** - The level at which the ground surface meets the foundation of a building.

**Flashing** - A thin flat metal positioned under/behind roofing, windows, doors, corner posts, etc. to keep draining water from penetrating the house.

**Frieze Board** - A horizontal member connecting the top of the siding with the soffit

**Furring/Furring Strip** - Furring strips are long, thin strips of wood, metal or Fiber Cement used to make backing surfaces to support the finished surfaces.

**Gable** - The end of a wall that is created when a roof line is pitched and slopes in two directions.

**Galvanized** - Covered with zinc. Either hot-dipped or electro-plated.

**Grade** - The height of the ground on which something stands.

**Horizontal** - Parallel to the horizon; on a level.

**Joint Flashing** - An additional weather resistive barrier placed behind a butt joint.

**Lap** - To over lap a course of siding with another course of siding.

**Level** - A position of measurement truly and exactly horizontal, 90° from a plumb surface.

**Light Block** - Decorative trim item placed under light fixtures and other exterior fixtures.

**Miter** - To make a diagonal cut, beveled to a specific angle 45° and 22 1/2° are common.





# Appendix C (cont.)

**Mud Sill** - A building member resting and normally attached to the foundation of a building running around the perimeter of the building. Also known as sill plate.

**OSB** - Oriented Strand Board. A common type of structural panel sheathing.

**PEL** - Permissible Exposure Limit. The maximum daily exposure level to respirable silica. OSHA's Personal Exposure Limit is 0.05 mg/m<sup>3</sup>.

**Plumb** - A position of measurement truly and exactly vertical, 90° from a level surface.

**Plunge Cut** - The act of driving a saw into the body of a material.

**Rafter Tail** - The end of a rafter extending past the wall assembly.

**Rain Screen Wall** - Consists of an exterior cladding, a cavity behind the cladding typically created through the use of furring strips for the purpose of drainage and venting to the outside; an innerwall plane incorporating a weather resistive barrier.

**Rake Board** - Decorative trim placed at an angle.

**Rigid Sheathing** - Plywood or OSB.

**Rim Joist** - The board that the rest of the joists are nailed to. It runs the entire perimeter of the house.

**Rip Cut** - Cut along the grain, usually lengthwise on a board.

**Scroll Work** - Decorative trim work.

**Sheathing** - Sheets of plywood, gypsum board, or other material nailed to the outside face of studs as a base for exterior siding.

**Shim** - A building material, usually wood, used to even a surface.

**Silica** - Mineral that is composed of silicon dioxide, SiO<sub>2</sub>.

**Speed Square** - Triangle shaped measuring device used in a variety of framing and siding applications.

**Stage** - To deliver, stack, or store material in a specific location.

**Starter Strip** - An accessory used under the first course of siding to provide a consistent plank angle.

**Sub-Fascia** - Framing member attached to the rafter tails used to support the fascia or used to pad out the fascia.

**T-Shed** - A shed with a single vertical wall and a roof that hangs off that wall on either side. The cross section of the shed is shaped like a 'T'.

**Vertical** - Being or situated at right angles to the horizon; upright.

**Weather Cut**- 15° to 45° cut used to join two boards.

**Weather-Resistive Barrier**- A building paper that protects building materials from exterior water penetration.

**Z-Flashing**- A piece of flashing bent into the shape of a "z". Used over window trim, band boards, panel intersections, and other vertical surfaces.



## Code References

Note: All building work must be in accordance with the applicable local building codes. The following is a list of the key code clauses. It is provided as a reference tool and not intended to be a substitute for proper design of approved construction. ASTM E1825 also provides guidance on the evaluation of materials, products and systems used in exterior wall construction.

### Site and Foundations

2003,2006,2009,2012, 2015 International Building Code  
Chapter 18 Foundations and Retaining Walls  
1803.3 (03,06) Site grading; 1804.3 (09,12) Site grading;  
1804.4 (15) Site grading

2003 2006, 2009, 2012, 2015 International Residential Code for One- and Two- Family Dwellings  
Chapter 4 Foundations  
R401.3 Drainage

### Ground Clearances

2003, 2006, 2009, 2012, 2015 International Building Code  
Chapter 18 Foundations and Retaining Walls  
1803.3 (03,06) Site grading; 1804.3 (09,12) Site grading;  
1804.4 (15) Site grading  
Chapter 23 Wood  
2304.11.2.2 (03, 06, 09, 12)Wood supported by exterior foundation walls.

2304.12.1.2 (15) Wood supported by exterior foundation walls  
2003, 2006, 2009, 2012, 2015 International Residential Code for One- and Two- Family Dwellings  
Chapter 3 Building Planning  
Chapter 4 Foundations  
R404.1.6 Height above finished grade

### Moisture Management

2003, 2006, 2009, 2012, 2015 International Building Code  
Chapter 14 Exterior Walls  
1404.1 General  
1404.2 Weather-resistive barrier  
1405.1 General  
1405.2 Weather Protection  
1405.3 Flashing (03,06)  
1405.4 Flashing (09,12, 15)  
1405.17 (03,06) Joints  
1405.16 (09,12, 15) Joints

2003, 2006, 2009, 2012, 2015 International Residential Code for One- and Two- Family Dwellings  
Chapter 7 Wall Covering  
R703.2 Weather-resistant barrier  
R703.8 Flashing  
R703.10 Joints

### Wall Construction

2003, 2006, 2009, 2012, 2015 International Building Code  
Chapter 22 Steel  
Chapter 23 Wood

2003, 2006, 2009, 2012, 2015 International Residential Code for One- and Two- Family Dwellings  
Chapter 6 Wall Construction  
R602.10 Wall bracing

### Fastening

2003, 2006, 2009, 2012, 2015 International Building Code  
Chapter 14 Exterior Walls  
1405.15 (03,06) Fiber cement siding  
1405.16 (09,12, 15) Fiber cement siding  
1406.2.2 (03, 06) Architectural trim  
1406.2.2.2( 09) Trim  
1406.2 (12, 15) Combustible exterior wall coverage

2003, 2006, 2009, 2012, 2015 International Residential Code for One- and Two- Family Dwellings  
Chapter 7 Wall Covering  
R703.4 (03, 06, 09, 12) Attachments  
R703.3 (15) Nominal thickness and attachments

To find the most current ESR reports please visit [www.icc-es.org](http://www.icc-es.org) and reference below for the corresponding ESR number for that product.

**HARDIEPLANK®  
LAP SIDING &  
HARDIESHINGLE®  
SIDING  
ESR 2290**

**HARDIEPANEL®  
VERTICAL SIDING  
ESR 1844**

**HARDIESOFFIT®  
PANELS  
ESR 2273**

**HARDIEBACKER®  
CEMENT BOARDS  
ESR 2280**

**HARDIEWRAP®  
WEATHER BARRIER  
ESR 2658**







1.866.4HARDIE

1.866.442.7343

[jameshardie.com](http://jameshardie.com)

© 2019 James Hardie Building Products Inc. All rights reserved. TM, SM, and ® denote trademarks of James Hardie Building Products. Printed in the U.S.A.

